

Tarifa 705

**Series de
mecanismos y
soluciones KNX**

Enero 2018

:hager

Hay mucho por hacer. Avancemos juntos.

Es el momento de
renovar las instalaciones
eléctricas y abrir paso
a las soluciones
inteligentes.



Apreciado colaborador y amigo,

Nuestra experiencia es un gran aliado, que nos permite ganar en eficacia y en fiabilidad. Nuestro saber hacer nos permite ahorrar tiempo, dinero y energía. Pero hay también momentos en la vida, en los que hay que salir de nuestra zona de confort y aventurarse a la conquista de las oportunidades únicas que se nos ofrecen.

Este momento ha llegado.

Las energías renovables y las nuevas tecnologías de los edificios nos permiten crear viviendas más inteligentes con un menor consumo de energía. Y con nuestras soluciones Ambient Assisted Living (AAL), podremos ayudar a las personas mayores y dependientes ofreciéndoles seguridad y facilitándoles su día a día. Recientes estudios indican que debemos adaptar el parque inmobiliario existente para acomodar instalaciones solares, acumuladores de energía y dispositivos de control inteligente para los edificios.

Estos cambios requieren especialistas para llevarlos a cabo. Hay mucho por hacer. Pero juntos lo conseguiremos.

En Hager Group le ofrecemos los mejores productos, soluciones y servicios. Pero no nos detenemos aquí: tenemos más de 800 colaboradores trabajando en la permanente mejora de nuestros productos y en el desarrollo de tecnologías innovadoras que le simplifican su trabajo y le hacen la vida más cómoda a sus clientes. Al mismo tiempo, nos estamos orientando cada vez más hacia los servicios, de forma que podamos proveerle a usted y a sus clientes una atención y acompañamiento más eficientes.

Más que una filosofía, el cambio es para nosotros una práctica que adoptamos en nuestro día a día, gracias al apoyo de colaboradores competentes como usted. El futuro empieza ahora y juntos podremos darle forma.

Atentamente,

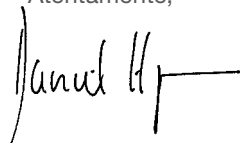

Daniel Hager
Hager Group CEO

Bajo un solo techo

Miembros de Hager Group

:hager

B.
Berker

ELCOM.

DAITEM

diagral

EFEN 

BOCCHIOTTI

Una familia

El mundo cambia, y nosotros también.

Como empresa familiar, hemos crecido de forma constante durante los últimos 60 años convirtiéndonos en un partner de confianza para técnicos expertos y distribuidores en todo el mundo. Y todo ello mientras permanecemos fieles a nosotros mismos y a nuestros valores.

Y así continuamos hoy, con un número de marcas bien conocidas – cada una con sus propias fortalezas- trabajando juntas bajo el paraguas de Hager Group.



Hager Forum en Obernai, Francia, es un espacio donde podemos trabajar con clientes y colaboradores y afrontar el futuro. Representa el símbolo perfecto del poder de innovación de Hager Group.

hagergroup

Su confianza

Hemos unificado nuestra imagen para poner en evidencia nuestra fuerza colectiva: todas nuestras marcas están ahora claramente identificadas como 'marcas de Hager Group'. La nueva imagen corporativa aporta ligeros cambios en los colores y las formas, pero lo esencial permanece: siempre trabajaremos con usted para lograr el éxito juntos.

Nuestras fortalezas

Tenemos enormes oportunidades por delante. Modernización de los edificios existentes, edificios con tecnología inteligente, servicios digitales, nuevas fuentes de energía y tecnologías - todo ello son formidables oportunidades que se ofrecen a nosotros. Al mismo tiempo, las exigencias que pesan sobre las empresas son cada vez más complejas. Por esta razón, es importante para usted tener a nuestros especialistas Hager ofreciéndole soporte y toda su profesionalidad. Juntos, somos más fuertes. Juntos superaremos los complejos desafíos de nuestro tiempo con sencillas y convincentes soluciones, tal y como hemos estado haciendo durante las últimas seis décadas.

Escoja la movilidad en su día a día



Hager e-catalogue

**Acceda a los datos técnicos
y hojas de instrucciones de
los productos**

Siga el día a día de nuestras
últimas innovaciones.



Hager.media

**Toda la oferta Hager,
en sus manos**

Consulte nuestro catálogo,
documentos técnicos, folletos
comerciales, guías
de selección, videos...



domovea

**Una ventana a la instalación
KNX**

Control total de su instalación KNX
desde cualquier lugar.



Ahorre tiempo, haga su día a día más fácil y responda a las expectativas de sus clientes con nuestras aplicaciones móviles.

easy

Hace fácil la instalación inteligente

Con el modo de configuración easy tendrá acceso a numerosas funciones KNX sin utilizar ETS.



coviva

Le conecta con su casa

Junto con el controlador coviva, permite una interacción sencilla y segura con su hogar conectado.



Disponible
2º trimestre 2018

Hager IoT

Internet de las cosas

El controlador TJA560 es una pasarela que hace su instalación KNX compatible con dispositivos IoT.



Instale las aplicaciones Hager en su móvil o tablet.



Estudio y cálculo

Planifique y cifre sus proyectos terciarios



hagercad.project

El nuevo software de Hager para la concepción y cálculo de cuadros eléctricos hasta 4.000 A, es una herramienta completa e innovadora que le garantiza total compatibilidad, seguridad y rapidez de ejecución. El acabado más profesional, que le permitirá fácilmente proyectar, optimizar y convencer.

¡Descubra sus ventajas!

hager.es/hagercad

Servicio 5 estrellas

Una relación de proximidad



Una fuerza comercial dedicada a sus proyectos

Nuestro equipo está realmente muy cerca de usted y le acompaña paso a paso en sus proyectos, proponiendo soluciones innovadoras, fáciles de instalar y usar, para satisfacer todas sus exigencias.



Una asistencia experta y de proximidad

¿Una pregunta técnica o relacionada con la instalación y/o utilización de nuestros programas o productos? Nuestros técnicos expertos le aconsejarán y le asistirán.

Contáctenos:

▶ N° Telf.

Ver teléfonos de contacto para cada zona en mapa de delegaciones (pág. 309)

▶ Web

hager.es/asistencia-tecnica

▶ Redes sociales

HagerSpain



switchondesigns.com

BLOG



Una logística dedicada

A lo largo de toda la vida de su proyecto, aplicamos una logística adaptada:

- seguimiento personalizados de los pedidos
- acondicionamiento específico del proyecto
- plazos de entrega



La elección de una distribución profesional

Hace ya más de 60 años que Hager optó por su distribuidor de material eléctrico como único socio para la difusión de sus productos. Nuestros distribuidores le garantizarán la entrega de productos de calidad.

Series - lumina 2

Series berker

Series técnicas: industriales y estancas

berker.Net

KNX series de mecanismos

KNX tebis

Guía técnica

Servicios

lumina 2

35



Series lumina 2

berker S.1 | B.3 | B.7 | Q.1 | Q.3 | Q.7 | K.1 | K.5
Arsys | R.1 | R.3 | Serie R.classic | Serie 1930
Serie 1930 Porzellan made by Rosenthal | Serie Glas

47



Series berker

berker Integro | cubyko IP55

149



Series técnicas

berker.Net

171



berker.Net

Series de mecanismos KNX

185



KNX series de mecanismos

quicklink | easy | ETS

211



KNX tebis

Limpieza y cuidado | lumina 2 | Estancas IP44 |
Medidas series berker | cubyko | Configuración
quicklink Actuadores KNX | Certificados de
producto | Materiales y colores

247

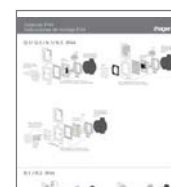

Guía técnica

berker Manufaktur | Índice de referencias
Condiciones de venta | Mapa delegaciones

285

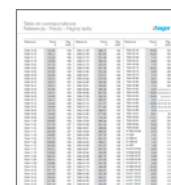

Servicios

berker significa excelencia en el diseño



berker R.1



berker R.3



berker Serie R.classic



berker Q.1



DESIGN PLUS



berker Q.7



berker S1



Termostato digital y
controlador de ambiente



berker
Touch Control



berker R.1 / R.3
Touch Sensor



2013 ■

Las series de mecanismos berker marcan la diferencia. Al menos esa no sólo es la opinión de muchos clientes, sino también la de los jurados de los numerosos concursos nacionales e internacionales que han ganado una y otra vez.









DESIGN **PLUS**

DESIGN **PLUS**



DESIGN **PLUS**
powered by: light+building



lumina 2		berker S.1				
blanco polar	blanco	blanco brillo	blanco polar brillo	blanco polar mate	aluminio	antracita
						

berker B.3					
aluminio / blanco polar mate	aluminio / antracita	aluminio dorado* / blanco polar mate	aluminio negro* / blanco polar mate	aluminio marrón* / blanco polar mate	aluminio rojo* / blanco polar mate
					





* las versiones dorado, negro, marrón y rojo existen también combinadas con embellecedor y tecla antracita

berker B.7							
blanco polar mate	aluminio	antracita	aluminio* blanco polar mate	acero* blanco polar mate	crystal blanco polar mate	crystal antracita	crystal aluminio
							

* también combinadas con embellecedor y tecla antracita

berker Q.1				berker Q.3			
blanco	blanco polar	antracita	aluminio	blanco	blanco polar	antracita	aluminio
NUEVO 			NUEVO 	NUEVO 			NUEVO 

berker Q.7 NUEVO								
blanco / aluminio / antracita			aluminio	acero inoxidable	crystal blanco	crystal negro	pizarra natural	hormigón
								

berker K.1		berker K.5	
blanco polar	antracita	aluminio E6EV1	acero
			

berker Arsys

blanco	blanco polar	marrón	bronce	dorado	acero inoxidable	cobre
						

Arsys Kupfer Med

berker R.1

blanco polar brillo	negro brillo	aluminio blanco polar	aluminio negro	acero blanco polar	acero negro	crystal blanco polar	crystal negro
							
pizarra blanco polar	pizarra negro	hormigón blanco polar	hormigón negro	piel marrón blanco polar	piel marrón negro	madera blanco polar	madera negro
							
acrílico rojo / blanco polar	acrílico rojo / negro	acrílico naranja / blanco polar	acrílico naranja / negro				
							





berker R.3

blanco polar brillo	negro brillo	aluminio blanco polar	aluminio negro	acero blanco polar	acero negro	crystal blanco polar	crystal negro
							

Serie R.classic

blanco polar brillo	negro brillo	aluminio blanco polar	aluminio negro	acero blanco polar	acero negro	crystal blanco polar	crystal negro
							

Serie 1930

blanco polar	negro	blanco polar Porzellan made by Rosenthal	negro Porzellan made by Rosenthal
		 <i>Rosenthal</i>	 <i>Rosenthal</i>

Serie Glas

crystal blanco / blanco polar	crystal blanco / negro	crystal blanco polar / blanco polar	crystal blanco polar / negro
			

lumina 2

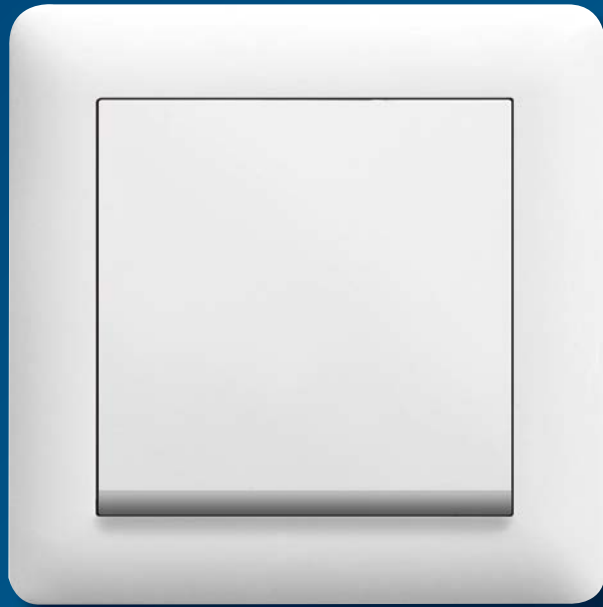



Estándar de calidad

Más que un estándar





La serie de dispositivos para instalaciones eléctricas lumina 2 es la respuesta de la empresa Hager a las necesidades del mercado actual que exige soluciones económicas óptimas y en el que los precios atractivos son el factor más decisivo.

hager.es/lumina2

:hager

		blanco polar		blanco	
					
		Ref.	Precio	Ref.	Precio
Interruptor	Mecanismo con tecla Marco 1 elemento	WL0010	3,72	WL0011	3,72
		WL5010	0,94 4,66	WL5011	0,94 4,66
Conmutador	Mecanismo con tecla Marco 1 elemento	WL0020	4,58	WL0021	4,58
		WL5010	0,94 5,52	WL5011	0,94 5,52
Cruzamiento	Mecanismo con tecla Marco 1 elemento	WL0030	9,37	WL0031	9,37
		WL5010	0,94 10,31	WL5011	0,94 10,31
Toma SCHUKO	Mecanismo con tapa Marco 1 elemento	WL1060	4,03	WL1061	4,03
		WL5010	0,94 4,97	WL5011	0,94 4,97
Pulsador	Mecanismo con tecla Marco 1 elemento	WL0110	5,49	WL0111	5,49
		WL5010	0,94 6,43	WL5011	0,94 6,43
Pulsador timbre	Mecanismo con tecla Tecla campana Marco 1 elemento	WL0110	5,49	WL0111	5,49
		WL6010	1,50	WL6011	1,50
		WL5010	0,94	WL5011	0,94
			7,93		7,93
Doble interruptor	Mecanismo con teclas Marco 1 elemento	WL0040	6,31	WL0041	6,31
		WL5010	0,94 7,25	WL5011	0,94 7,25
Doble conmutador	Mecanismo con teclas Marco 1 elemento	WL0050	7,28	WL0051	7,28
		WL5010	0,94 8,22	WL5011	0,94 8,22
Doble interruptor persianas	Mecanismo con teclas Marco 1 elemento	WL0310	15,50	WL0311	15,50
		WL5010	0,94 16,44	WL5011	0,94 16,44
Doble pulsador persianas	Mecanismo con teclas Marco 1 elemento	WL0320	15,76	WL0321	15,76
		WL5010	0,94 16,70	WL5011	0,94 16,70
Toma teléfono	Mecanismo con tapa Marco 1 elemento	WL2010	9,56	WL2011	9,56
		WL5010	0,94 10,50	WL5011	0,94 10,50
Toma simple RJ45 cat. 5e	Mecanismo con tapa Marco 1 elemento	WL2110	14,50	WL2111	14,50
		WL5010	0,94 15,44	WL5011	0,94 15,44
Toma doble RJ45 cat. 5e	Mecanismo con tapa Marco 1 elemento	WL2120	29,00	WL2121	29,00
		WL5010	0,94 29,94	WL5011	0,94 29,94
Toma TV	Mecanismo con tapa Marco 1 elemento	WL3010	17,83	WL3011	17,83
		WL5010	0,94 18,77	WL5011	0,94 18,77
Tapa ciega	Mecanismo con tapa Marco 1 elemento	WL7010	5,94	WL7011	5,94
		WL5010	0,94 6,88	WL5011	0,94 6,88
Regulador rotativo	Mecanismo con tapa Marco 1 elemento	WL4010	48,29	WL4011	48,29
		WL5010	0,94 49,23	WL5011	0,94 49,23
Marco vertical	2 elementos	WL5120	1,70	WL5121	1,70
	3 elementos	WL5130	2,73	WL5131	2,73
	4 elementos	WL5140	4,87	WL5141	4,87
	5 elementos	WL5150	6,70	WL5151	6,70
Marco horizontal	2 elementos	WL5220	1,70	WL5221	1,70
	3 elementos	WL5230	2,73	WL5231	2,73
	4 elementos	WL5240	4,87	WL5241	4,87
	5 elementos	WL5250	6,70	WL5251	6,70





Precios en (€)

		aluminio / blanco polar mate		aluminio / antracita		aluminio / dorado / blanco polar mate		aluminio dorado / antracita	
									
		Ref.	Precio	Ref.	Precio	Ref.	Precio	Ref.	Precio
Interruptor	Mecanismo Tecla Marco 1 elemento	3031 1620 19 09 1011 39 04	3,67 1,43 16,47	3031 1620 16 06 1011 30 04	3,67 2,70 17,74	3031 1620 19 09 1011 30 46	3,67 1,43 21,42	3031 1620 16 06 1011 30 16	3,67 2,70 22,69
Conmutador	Mecanismo Tecla Marco 1 elemento	3036 1620 19 09 1011 39 04	4,18 1,43 16,98	3036 1620 16 06 1011 30 04	4,18 2,70 18,25	3036 1620 19 09 1011 30 46	4,18 1,43 21,93	3036 1620 16 06 1011 30 16	4,18 2,70 23,20
Cruzamiento	Mecanismo Tecla Marco 1 elemento	3037 1620 19 09 1011 39 04	8,69 1,43 21,49	3037 1620 16 06 1011 30 04	8,69 2,70 22,76	3037 1620 19 09 1011 30 46	8,69 1,43 26,44	3037 1620 16 06 1011 30 16	8,69 2,70 27,71
Toma SCHUKO*	Mecanismo Tapa Marco 1 elemento	7141 34 1719 19 09 1011 39 04	4,24 4,12 19,73	7141 34 1719 16 06 1011 30 04	4,24 4,40 20,01	7141 34 1719 19 09 1011 30 46	4,24 4,12 24,68	7141 34 1719 16 06 1011 30 16	4,24 4,40 24,96
Pulsador	Mecanismo Tecla Marco 1 elemento	5031 1620 19 09 1011 39 04	4,50 1,43 17,30	5031 1620 16 06 1011 30 04	4,50 2,70 18,57	5031 1620 19 09 1011 30 46	4,50 1,43 22,25	5031 1620 16 06 1011 30 16	4,50 2,70 23,52
Doble interruptor	Mecanismo Tecla Marco 1 elemento	3035 1623 19 09 1011 39 04	5,51 2,55 19,43	3035 1623 16 06 1011 30 04	5,51 5,30 22,18	3035 1623 19 09 1011 30 46	5,51 2,55 24,38	3035 1623 16 06 1011 30 16	5,51 5,30 27,13
Doble conmutador	Mecanismo Tecla Marco 1 elemento	3038 08 1623 19 09 1011 39 04	13,67 2,55 27,59	3038 08 1623 16 06 1011 30 04	13,67 5,30 30,34	3038 08 1623 19 09 1011 30 46	13,67 2,55 32,54	3038 08 1623 16 06 1011 30 16	13,67 5,30 35,29
Doble interruptor persianas	Mecanismo Tecla doble con flecha Marco 1 elemento	3035 20 1625 19 09 1011 39 04	12,65 5,92 29,94	3035 20 1625 16 06 1011 30 04	12,65 9,20 33,22	3035 20 1625 19 09 1011 30 46	12,65 5,92 36,89	3035 20 1625 16 06 1011 30 16	12,65 9,20 38,17
Doble pulsador persianas	Mecanismo Tecla doble con flecha Marco 1 elemento	5035 20 1625 19 09 1011 39 04	12,04 5,92 29,33	5035 20 1625 16 06 1011 30 04	12,04 9,20 32,61	5035 20 1625 19 09 1011 30 46	12,04 5,92 34,28	5035 20 1625 16 06 1011 30 16	12,04 9,20 37,56
Toma teléfono cat. 3	Mecanismo Tapa Marco 1 elemento	4538 1407 19 09 1011 39 04	8,67 3,77 23,81	4538 1407 16 06 1011 30 04	8,67 5,80 25,84	4538 1407 19 09 1011 30 46	8,67 3,77 28,76	4538 1407 16 06 1011 30 16	8,67 5,80 30,79
Toma simple RJ45 cat. 6a	Mecanismo Tapa Marco 1 elemento	4554 01 1407 19 09 1011 39 04	21,00 3,77 36,14	4554 01 1407 16 06 1011 30 04	21,00 5,80 38,17	4554 01 1407 19 09 1011 30 46	21,00 3,77 41,09	4554 01 1407 16 06 1011 30 16	21,00 5,80 43,12
Toma doble RJ45 cat. 6a	Mecanismo Tapa Marco 1 elemento	4555 01 1409 19 09 1011 39 04	27,00 5,63 44,00	4555 01 1409 16 06 1011 30 04	27,00 7,00 45,37	4555 01 1409 19 09 1011 30 46	27,00 5,63 48,95	4555 01 1409 16 06 1011 30 16	27,00 7,00 50,32
Toma TV	Mecanismo Tapa Marco 1 elemento	4522 10 1203 19 09 1011 39 04	15,30 1,94 28,61	4522 10 1203 16 06 1011 30 04	15,30 7,70 34,37	4522 10 1203 19 09 1011 30 46	15,30 1,94 33,56	4522 10 1203 16 06 1011 30 16	15,30 7,70 39,32
Salida de hilos	Mecanismo Tapa Marco 1 elemento	4470 1019 19 09 1011 39 04	10,00 4,65 26,02	4470 1019 16 06 1011 30 04	10,00 7,14 28,51	4470 1019 19 09 1011 30 46	10,00 4,65 30,97	4470 1019 16 06 1011 30 16	10,00 7,14 33,46
Tapa ciega	Mecanismo con tapa Marco 1 elemento	1009 19 09 1011 39 04	8,57 11,37 19,94	1009 16 06 1011 30 04	11,10 11,37 22,47	1009 19 09 1011 30 46	8,57 16,32 24,89	1009 16 06 1011 30 16	11,10 16,32 27,42
Marco	2 elementos 3 elementos 4 elementos 5 elementos	1012 39 04 1013 39 04 1014 39 04 1015 39 04	18,48 25,50 38,63 47,71	1012 30 04 1013 30 04 1014 30 04 1015 30 04	18,48 25,50 38,63 47,71	1012 30 46 1013 30 46 1014 30 46 1015 30 46	26,52 36,62 55,49 68,54	1012 30 16 1013 30 16 1014 30 16 1015 30 16	26,52 36,62 55,49 68,54

* toma SCHUKO con protección infantil y conexión por tornillos

Precios en (€)



<p>Nota: La gama berker B.3 está disponible también en los siguientes acabados: negro, marrón y rojo. Estos acabados, existen también combinados con embellecedor y tecla antracita.</p>	<p>aluminio negro / blanco polar mate</p> 	<p>aluminio marrón / blanco polar mate</p> 	<p>aluminio rojo / blanco polar mate</p> 
---	---	---	--

		aluminio* / blanco polar mate		aluminio / antracita		acero* / blanco polar mate		acero / antracita	
									
		Ref.	Precio	Ref.	Precio	Ref.	Precio	Ref.	Precio
Interruptor	Mecanismo Tecla Marco 1 elemento	3031 1620 19 09 1011 69 14	3,67 1,43 40,00 45,10	3031 1620 16 06 1011 69 04	3,67 2,70 40,00 46,37	3031 1620 19 09 1011 36 09	3,67 1,43 45,00 50,10	3031 1620 16 06 1011 36 06	3,67 2,70 45,00 51,37
Conmutador	Mecanismo Tecla Marco 1 elemento	3036 1620 19 09 1011 69 14	4,18 1,43 40,00 45,61	3036 1620 16 06 1011 69 04	4,18 2,70 40,00 46,88	3036 1620 19 09 1011 36 09	4,18 1,43 45,00 50,61	3036 1620 16 06 1011 36 06	4,18 2,70 45,00 51,88
Cruzamiento	Mecanismo Tecla Marco 1 elemento	3037 1620 19 09 1011 69 14	8,69 1,43 40,00 50,12	3037 1620 16 06 1011 69 04	8,69 2,70 40,00 51,39	3037 1620 19 09 1011 36 09	8,69 1,43 45,00 55,12	3037 1620 16 06 1011 36 06	8,69 2,70 45,00 56,39
Toma SCHUKO*	Mecanismo Tapa Marco 1 elemento	7141 34 1719 19 09 1011 69 14	4,24 4,12 40,00 48,36	7141 34 1719 16 06 1011 69 04	4,24 4,40 40,00 48,64	7141 34 1719 19 09 1011 36 09	4,24 4,12 45,00 53,36	7141 34 1719 16 06 1011 36 06	4,24 4,40 45,00 53,64
Pulsador	Mecanismo Tecla Marco 1 elemento	5031 1620 19 09 1011 69 14	4,50 1,43 40,00 45,93	5031 1620 16 06 1011 69 04	4,50 2,70 40,00 47,20	5031 1620 19 09 1011 36 09	4,50 1,43 45,00 50,93	5031 1620 16 06 1011 36 06	4,50 2,70 45,00 52,20
Doble interruptor	Mecanismo Tecla Marco 1 elemento	3035 1623 19 09 1011 69 14	5,51 2,55 40,00 48,06	3035 1623 16 06 1011 69 04	5,51 5,30 40,00 50,81	3035 1623 19 09 1011 36 09	5,51 2,55 45,00 53,06	3035 1623 16 06 1011 36 06	5,51 5,30 45,00 55,81
Doble conmutador	Mecanismo Tecla Marco 1 elemento	3038 08 1623 19 09 1011 69 14	13,67 2,55 40,00 56,22	3038 08 1623 16 06 1011 69 04	13,67 5,30 40,00 58,97	3038 08 1623 19 09 1011 36 09	13,67 2,55 45,00 61,22	3038 08 1623 16 06 1011 36 06	13,67 5,30 45,00 63,97
Doble interruptor persianas	Mecanismo Tecla doble con flecha Marco 1 elemento	3035 20 1625 19 09 1011 69 14	12,65 5,92 40,00 58,57	3035 20 1625 16 06 1011 69 04	12,65 9,20 40,00 61,85	3035 20 1625 19 09 1011 36 09	12,65 5,92 45,00 63,57	3035 20 1625 16 06 1011 36 06	12,65 9,20 45,00 66,85
Doble pulsador persianas	Mecanismo Tecla doble con flecha Marco 1 elemento	5035 20 1625 19 09 1011 69 14	12,04 5,92 40,00 57,96	5035 20 1625 16 06 1011 69 04	12,04 9,20 40,00 61,24	5035 20 1625 19 09 1011 36 09	12,04 5,92 45,00 62,96	5035 20 1625 16 06 1011 36 06	12,04 9,20 45,00 66,24
Toma teléfono cat. 3	Mecanismo Tapa Marco 1 elemento	4538 1407 19 09 1011 69 14	8,67 3,77 40,00 52,44	4538 1407 16 06 1011 69 04	8,67 5,80 40,00 54,47	4538 1407 19 09 1011 36 09	8,67 3,77 45,00 57,44	4538 1407 16 06 1011 36 06	8,67 5,80 45,00 59,47
Toma simple RJ45 cat. 6a	Mecanismo Tapa Marco 1 elemento	4554 01 1407 19 09 1011 69 14	21,00 3,77 40,00 64,77	4554 01 1407 16 06 1011 69 04	21,00 5,80 40,00 66,80	4554 01 1407 19 09 1011 36 09	21,00 3,77 45,00 69,77	4554 01 1407 16 06 1011 36 06	21,00 5,80 45,00 71,80
Toma doble RJ45 cat. 6a	Mecanismo Tapa Marco 1 elemento	4555 01 1409 19 09 1011 69 14	27,00 5,63 40,00 72,63	4555 01 1409 16 06 1011 69 04	27,00 7,00 40,00 74,00	4555 01 1409 19 09 1011 36 09	27,00 5,63 45,00 77,63	4555 01 1409 16 06 1011 36 06	27,00 7,00 45,00 79,00
Toma TV	Mecanismo Tapa Marco 1 elemento	4522 10 1203 19 09 1011 69 14	15,30 1,94 40,00 57,24	4522 10 1203 16 06 1011 69 04	15,30 7,70 40,00 63,00	4522 10 1203 19 09 1011 36 09	15,30 1,94 45,00 62,24	4522 10 1203 16 06 1011 36 06	15,30 7,70 45,00 68,00
Salida de hilos	Mecanismo Tapa Marco 1 elemento	4470 1019 19 09 1011 69 14	10,00 4,65 40,00 54,65	4470 1019 16 06 1011 69 04	10,00 7,14 40,00 57,14	4470 1019 19 09 1011 36 09	10,00 4,65 45,00 59,65	4470 1019 16 06 1011 36 06	10,00 7,14 45,00 62,14
Tapa ciega	Mecanismo con tapa Marco 1 elemento	1009 19 09 1011 69 14	8,57 40,00 48,57	1009 16 06 1011 69 04	11,10 40,00 51,10	1009 19 09 1011 36 09	8,57 45,00 53,57	1009 16 06 1011 36 06	11,10 45,00 56,10
Marco	2 elementos 3 elementos 4 elementos 5 elementos	1012 69 14 1013 69 14 1014 69 14 1015 69 14	70,62 80,89 110,63 150,78	1012 69 04 1013 69 04 1014 69 04 1015 69 04	70,62 78,42 107,25 146,17	1022 36 09 1023 36 09 1024 36 09 1025 36 09	79,45 132,85 181,71 190,00	1022 36 06 1023 36 06 1024 36 06 1025 36 06	79,45 132,85 181,71 190,00

* toma SCHUKO con protección infantil y conexión por tornillos

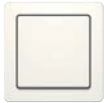
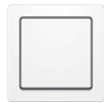

Precios en (€)

* Los acabados aluminio y acero blanco polar existen también combinados con embellecedor y tecla antracita.

		blanco		blanco polar		antracita		aluminio	
									
		Ref.	Precio	Ref.	Precio	Ref.	Precio	Ref.	Precio
Interruptor	Mecanismo Tecla Marco 1 elemento	3031 1620 60 82 1011 60 82	3,67 2,24 1,63 7,54	3031 1620 60 89 1011 60 89	3,67 2,24 1,63 7,54	3031 1620 60 86 1011 60 86	3,67 3,92 4,72 12,31	3031 1620 60 84 1011 60 84	3,67 3,92 4,72 12,31
Conmutador	Mecanismo Tecla Marco 1 elemento	3036 1620 60 82 1011 60 82	4,18 2,24 1,63 8,05	3036 1620 60 89 1011 60 89	4,18 2,24 1,63 8,05	3036 1620 60 86 1011 60 86	4,18 3,92 4,72 12,82	3036 1620 60 84 1011 60 84	4,18 3,92 4,72 12,82
Cruzamiento	Mecanismo Tecla Marco 1 elemento	3037 1620 60 82 1011 60 82	8,69 2,24 1,63 12,56	3037 1620 60 89 1011 60 89	8,69 2,24 1,63 12,56	3037 1620 60 86 1011 60 86	8,69 3,92 4,72 17,33	3037 1620 60 84 1011 60 84	8,69 3,92 4,72 17,33
Toma SCHUKO*	Mecanismo Tapa Marco 1 elemento	7141 34 1719 60 72 1011 60 82	4,24 4,16 1,63 10,03	7141 34 1719 60 89 1011 60 89	4,24 4,16 1,63 10,03	7141 34 1719 60 86 1011 60 86	4,24 5,83 4,72 14,79	7141 34 1719 60 84 1011 60 84	4,24 5,83 4,72 14,79
Pulsador	Mecanismo Tecla Marco 1 elemento	5031 1620 60 82 1011 60 82	4,50 2,24 1,63 8,37	5031 1620 60 89 1011 60 89	4,50 2,24 1,63 8,37	5031 1620 60 86 1011 60 86	4,50 3,92 4,72 13,14	5031 1620 60 84 1011 60 84	4,50 3,92 4,72 13,14
Doble interruptor	Mecanismo Tecla Marco 1 elemento	3035 1623 60 82 1011 60 82	5,51 5,92 1,63 13,06	3035 1623 60 89 1011 60 89	5,51 5,92 1,63 13,06	3035 1623 60 86 1011 60 86	5,51 6,79 4,72 17,02	3035 1623 60 84 1011 60 84	5,51 6,79 4,72 17,02
Doble conmutador	Mecanismo Tecla Marco 1 elemento	3038 08 1623 60 82 1011 60 82	13,67 5,92 1,63 21,22	3038 08 1623 60 89 1011 60 89	13,67 5,92 1,63 21,22	3038 08 1623 60 86 1011 60 86	13,67 6,79 4,72 25,18	3038 08 1623 60 84 1011 60 84	13,67 6,79 4,72 25,18
Doble interruptor persianas	Mecanismo Tecla doble con flecha Marco 1 elemento	3035 20 1625 60 82 1011 60 82	12,65 6,63 1,63 20,91	3035 20 1625 60 89 1011 60 89	12,65 6,63 1,63 20,91	3035 20 1625 60 86 1011 60 86	12,65 9,14 4,72 26,51	3035 20 1625 60 84 1011 60 84	12,65 9,14 4,72 26,51
Doble pulsador persianas	Mecanismo Tecla doble con flecha Marco 1 elemento	5035 20 1625 60 82 1011 60 82	12,04 6,63 1,63 20,30	5035 20 1625 60 89 1011 60 89	12,04 6,63 1,63 20,30	5035 20 1625 60 86 1011 60 86	12,04 9,14 4,72 25,90	5035 20 1625 60 84 1011 60 84	12,04 9,14 4,72 25,90
Toma teléfono cat. 3	Mecanismo Tapa Marco 1 elemento	4538 1407 60 82 1011 60 82	8,67 5,10 1,63 15,40	4538 1407 60 89 1011 60 89	8,67 5,10 1,63 15,40	4538 1407 60 86 1011 60 86	8,67 7,66 4,72 21,05	4538 1407 60 84 1011 60 84	8,67 7,66 4,72 21,05
Toma simple RJ45 cat. 6a	Mecanismo Tapa Marco 1 elemento	4554 01 1407 60 82 1011 60 82	21,00 5,10 1,63 27,73	4554 01 1407 60 89 1011 60 89	21,00 5,10 1,63 27,73	4554 01 1407 60 86 1011 60 86	21,00 7,66 4,72 33,38	4554 01 1407 60 84 1011 60 84	21,00 7,66 4,72 33,38
Toma doble RJ45 cat. 6a	Mecanismo Tapa Marco 1 elemento	4555 01 1409 60 82 1011 60 82	27,00 5,10 1,63 33,73	4555 01 1409 60 89 1011 60 89	27,00 5,10 1,63 33,73	4555 01 1409 60 86 1011 60 86	27,00 7,66 4,72 39,38	4555 01 1409 60 84 1011 60 84	27,00 7,66 4,72 39,38
Toma TV	Mecanismo Tapa Marco 1 elemento	4522 10 1203 60 82 1011 60 82	15,30 4,69 1,63 21,62	4522 10 1203 60 89 1011 60 89	15,30 4,69 1,63 21,62	4522 10 1203 60 86 1011 60 86	15,30 7,66 4,72 27,68	4522 10 1203 60 84 1011 60 84	15,30 7,66 4,72 27,68
Salida de hilos	Mecanismo Tapa Marco 1 elemento	4470 1019 60 82 1011 60 82	10,00 6,32 1,63 17,95	4470 1019 60 89 1011 60 89	10,00 6,32 1,63 17,95	4470 1019 60 86 1011 60 86	10,00 7,66 4,72 22,38	4470 1019 60 84 1011 60 84	10,00 7,66 4,72 22,38
Tapa ciega	Mecanismo con tapa Marco 1 elemento	1009 60 82 1011 60 82	9,89 1,63 11,52	1009 60 89 1011 60 89	9,89 1,63 11,52	1009 60 86 1011 60 86	19,35 4,72 24,07	1009 60 84 1011 60 84	19,35 4,72 24,07
Marco	2 elementos 3 elementos 4 elementos 5 elementos	1012 60 82 1013 60 82 1014 60 82 1015 60 82	3,06 4,90 6,83 11,02	1012 60 89 1013 60 89 1014 60 89 1015 60 89	3,06 4,90 6,83 11,02	1012 60 86 1013 60 86 1014 60 86 1015 60 86	6,85 11,85 18,84 29,11	1012 60 84 1013 60 84 1014 60 84 1015 60 84	6,85 11,85 18,84 29,11



* toma SCHUKO con protección infantil y conexión por tornillos

Precios en (€)

		blanco polar		aluminio		antracita	
							
		Ref.	Precio	Ref.	Precio	Ref.	Precio
Interruptor	Mecanismo	3031	3,67	3031	3,67	3031	3,67
	Tecla	1620 60 89	2,24	1620 60 84	3,92	1620 60 86	3,92
	Marco 1 elemento	1011 61 89	3,00	1011 61 84	4,00	1011 61 86	4,00
			8,91		11,59		11,59
Conmutador	Mecanismo	3036	4,18	3036	4,18	3036	4,18
	Tecla	1620 60 89	2,24	1620 60 84	3,92	1620 60 86	3,92
	Marco 1 elemento	1011 61 89	3,00	1011 61 84	4,00	1011 61 86	4,00
			9,42		12,10		12,10
Cruzamiento	Mecanismo	3037	8,69	3037	8,69	3037	8,69
	Tecla	1620 60 89	2,24	1620 60 84	3,92	1620 60 86	3,92
	Marco 1 elemento	1011 61 89	3,00	1011 61 84	4,00	1011 61 86	4,00
			13,93		16,61		16,61
Toma SCHUKO*	Mecanismo	7141 34	4,24	7141 34	4,24	7141 34	4,24
	Tapa	1719 60 89	4,16	1719 60 74	5,83	1719 60 86	5,83
	Marco 1 elemento	1011 61 89	3,00	1011 61 84	4,00	1011 61 86	4,00
			11,40		14,07		14,07
Pulsador	Mecanismo	5031	4,50	5031	4,50	5031	4,50
	Tecla	1620 60 89	2,24	1620 60 84	3,92	1620 60 86	3,92
	Marco 1 elemento	1011 61 89	3,00	1011 61 84	4,00	1011 61 86	4,00
			9,74		12,42		12,42
Doble interruptor	Mecanismo	3035	5,51	3035	5,51	3035	5,51
	Tecla	1623 60 89	5,92	1623 60 84	6,79	1623 60 86	6,79
	Marco 1 elemento	1011 61 89	3,00	1011 61 84	4,00	1011 61 86	4,00
			14,43		16,30		16,30
Doble conmutador	Mecanismo	3038 08	13,67	3038 08	13,67	3038 08	13,67
	Tecla	1623 60 89	5,92	1623 60 84	6,79	1623 60 86	6,79
	Marco 1 elemento	1011 61 89	3,00	1011 61 84	4,00	1011 61 86	4,00
			22,59		24,46		24,46
Doble interruptor persianas	Mecanismo	3035 20	12,65	3035 20	12,65	3035 20	12,65
	Tecla doble con flecha	1625 60 89	6,63	1625 60 84	9,14	1625 60 86	9,14
	Marco 1 elemento	1011 61 89	3,00	1011 61 84	4,00	1011 61 86	4,00
			22,28		25,79		25,79
Doble pulsador persianas	Mecanismo	5035 20	12,04	5035 20	12,04	5035 20	12,04
	Tecla doble con flecha	1625 60 89	6,63	1625 60 84	9,14	1625 60 86	9,14
	Marco 1 elemento	1011 61 89	3,00	1011 61 84	4,00	1011 61 86	4,00
			21,67		25,18		25,18
Toma teléfono cat. 3	Mecanismo	4538	8,67	4538	8,67	4538	8,67
	Tapa	1407 60 89	5,10	1407 60 84	7,66	1407 60 86	7,66
	Marco 1 elemento	1011 60 89	3,00	1011 61 84	4,00	1011 61 86	4,00
			16,77		20,33		20,33
Toma simple RJ45 cat. 6a	Mecanismo	4554 01	21,00	4554 01	21,00	4554 01	21,00
	Tapa	1407 60 89	5,10	1407 60 84	7,66	1407 60 86	7,66
	Marco 1 elemento	1011 61 89	3,00	1011 61 84	4,00	1011 61 86	4,00
			29,10		32,66		32,66
Toma doble RJ45 cat. 6a	Mecanismo	4555 01	27,00	4555 01	27,00	4555 01	27,00
	Tapa	1409 60 89	5,10	1409 60 84	7,66	1409 60 86	7,66
	Marco 1 elemento	1011 61 89	3,00	1011 61 84	4,00	1011 61 86	4,00
			35,10		38,66		38,66
Toma TV	Mecanismo	4522 10	15,30	4522 10	15,30	4522 10	15,30
	Tapa	1203 60 89	4,69	1203 60 84	7,66	1203 60 86	7,66
	Marco 1 elemento	1011 61 89	3,00	1011 61 84	4,00	1011 61 86	4,00
			22,99		26,96		26,96
Salida de hilos	Mecanismo	4470	10,00	4470	10,00	4470	10,00
	Tapa	1019 60 89	6,32	1019 60 84	7,66	1019 60 86	7,66
	Marco 1 elemento	1011 60 89	3,00	1011 61 84	4,00	1011 61 86	4,00
			19,32		21,66		21,66
Tapa ciega	Mecanismo con tapa	1009 60 89	9,89	1009 60 84	19,35	1009 60 86	19,35
	Marco 1 elemento	1011 61 89	3,00	1011 61 84	4,00	1011 61 86	4,00
			12,89		23,35		23,35
Marco	2 elementos	1012 61 89	4,37	1012 61 84	6,25	1012 61 86	6,25
	3 elementos	1013 61 89	7,53	1013 61 84	10,06	1013 61 86	10,06
	4 elementos	1014 61 89	12,12	1014 61 84	16,21	1014 61 86	16,21
	5 elementos	1015 61 89	18,45	1015 61 84	24,66	1015 61 86	24,66

* toma SCHUKO con protección infantil y conexión por tornillos

Precios en (€)

		cristal blanco polar		cristal negro	
					
		Ref.	Precio	Ref.	Precio
Interruptor	Mecanismo	3031	3,67	3031	3,67
	Tecla	1620 20 89	2,32	1620 20 45	4,98
	Marco 1 elemento	1011 21 09	30,00	1011 21 16	30,00
			35,99		38,65
Conmutador	Mecanismo	3036	4,18	3036	4,18
	Tecla	1620 20 89	2,32	1620 20 45	4,98
	Marco 1 elemento	1011 21 09	30,00	1011 21 16	30,00
			36,50		39,16
Cruzamiento	Mecanismo	3037	8,69	3037	8,69
	Tecla	1620 20 89	2,32	1620 20 45	4,98
	Marco 1 elemento	1011 21 09	30,00	1011 21 16	30,00
			41,01		43,67
Toma SCHUKO*	Mecanismo	7141 34	4,24	7141 34	4,24
	Tapa	1719 20 89	3,72	1719 20 45	4,56
	Marco 1 elemento	1011 21 09	30,00	1011 21 16	30,00
			37,96		38,80
Pulsador	Mecanismo	5031	4,50	5031	4,50
	Tecla	1620 20 89	2,32	1620 20 45	4,98
	Marco 1 elemento	1011 21 09	30,00	1011 21 16	30,00
			36,82		39,48
Doble interruptor	Mecanismo	3035	5,51	3035	5,51
	Tecla	1623 20 89	3,28	1623 20 45	7,07
	Marco 1 elemento	1011 21 09	30,00	1011 21 16	30,00
			38,79		42,58
Doble conmutador	Mecanismo	3038 08	13,67	3038 08	13,67
	Tecla	1623 20 89	3,28	1623 20 45	7,07
	Marco 1 elemento	1011 21 09	30,00	1011 21 16	30,00
			46,95		50,74
Doble interruptor persianas	Mecanismo	3035 20	12,65	3035 20	12,65
	Tecla doble con flecha	1625 20 89	4,08	1625 20 45	8,76
	Marco 1 elemento	1011 21 09	30,00	1011 21 16	30,00
			46,73		51,41
Doble pulsador persianas	Mecanismo	5035 20	12,04	5035 20	12,04
	Tecla doble con flecha	1625 20 89	4,08	1625 20 45	8,76
	Marco 1 elemento	1011 21 09	30,00	1011 21 16	30,00
			46,12		50,80
Toma teléfono cat. 3	Mecanismo	4538	8,67	4538	8,67
	Tapa	1407 20 89	5,20	1407 20 45	5,62
	Marco 1 elemento	1011 21 09	30,00	1011 21 16	30,00
			43,87		44,29
Toma simple RJ45 cat. 6a	Mecanismo	4554 01	21,00	4554 01	21,00
	Tapa	1407 20 89	5,20	1407 20 45	5,62
	Marco 1 elemento	1011 21 09	30,00	1011 21 16	30,00
			56,20		56,62
Toma doble RJ45 cat. 6a	Mecanismo	4555 01	27,00	4555 01	27,00
	Tapa	1409 20 89	5,20	1409 20 45	5,62
	Marco 1 elemento	1011 21 09	30,00	1011 21 16	30,00
			62,20		62,62
Toma TV	Mecanismo	4522 10	15,30	4522 10	15,30
	Tapa	1203 20 89	5,20	1203 20 45	5,62
	Marco 1 elemento	1011 21 09	30,00	1011 21 16	30,00
			50,50		50,92
Salida de hilos	Mecanismo	4470	10,00	4470	10,00
	Tapa	1019 20 89	5,20	1019 20 45	5,62
	Marco 1 elemento	1011 21 09	30,00	1011 21 16	30,00
			45,20		45,62
Tapa ciega	Mec. con tapa	1009 20 89	8,24	1009 20 45	8,78
	Marco 1 elemento	1011 21 09	30,00	1011 21 16	30,00
			38,24		38,78
Marco	2 elementos	1012 21 09	52,97	1012 21 16	52,97
	3 elementos	1013 21 09	69,74	1013 21 16	68,84
	4 elementos	1014 21 09	95,39	1014 21 16	94,16
	5 elementos	1015 21 09	130,01	1015 21 16	128,32

* toma SCHUKO con protección infantil y conexión por tornillos

Nota:

La gama berker R.1 está disponible también en los siguientes acabados:

pizarra
blanco polar



pizarra
negro



hormigón
blanco polar



hormigón
negro



piel marrón
blanco polar



piel marrón
negro



madera
blanco polar



madera
negro



acrílico rojo
blanco polar



acrílico rojo
negro





acrílico naranja
blanco polar



acrílico naranja
negro



		cristal blanco polar		cristal negro	
					
		Ref.	Precio	Ref.	Precio
Interruptor	Mecanismo	3031	3,67	3031	3,67
	Tecla	1620 20 89	2,32	1620 20 45	4,98
	Marco 1 elemento	1011 22 09	30,00	1011 22 16	30,00
			35,99		38,65
Conmutador	Mecanismo	3036	4,18	3036	4,18
	Tecla	1620 20 89	2,32	1620 20 45	4,98
	Marco 1 elemento	1011 22 09	30,00	1011 22 16	30,00
			36,50		39,16
Cruzamiento	Mecanismo	3037	8,69	3037	8,69
	Tecla	1620 20 89	2,32	1620 20 45	4,98
	Marco 1 elemento	1011 22 09	30,00	1011 22 16	30,00
			41,01		43,67
Toma SCHUKO*	Mecanismo	7141 34	4,24	7141 34	4,24
	Tapa	1719 20 89	3,72	1719 20 45	4,56
	Marco 1 elemento	1011 22 09	30,00	1011 22 16	30,00
			37,96		38,80
Pulsador	Mecanismo	5031	4,50	5031	4,50
	Tecla	1620 20 89	2,32	1620 20 45	4,98
	Marco 1 elemento	1011 22 09	30,00	1011 22 16	30,00
			36,82		39,48
Doble interruptor	Mecanismo	3035	5,51	3035	5,51
	Tecla	1623 20 89	3,28	1623 20 45	7,07
	Marco 1 elemento	1011 22 09	30,00	1011 22 16	30,00
			38,79		42,58
Doble conmutador	Mecanismo	3038 08	13,67	3038 08	13,67
	Tecla	1623 20 89	3,28	1623 20 45	7,07
	Marco 1 elemento	1011 22 09	30,00	1011 22 16	30,00
			46,95		50,74
Doble interruptor persianas	Mecanismo	3035 20	12,65	3035 20	12,65
	Tecla doble con flecha	1625 20 89	4,08	1625 20 45	8,76
	Marco 1 elemento	1011 22 09	30,00	1011 22 16	30,00
			46,73		51,41
Doble pulsador persianas	Mecanismo	5035 20	12,04	5035 20	12,04
	Tecla doble con flecha	1625 20 89	4,08	1625 20 45	8,76
	Marco 1 elemento	1011 22 09	30,00	1011 22 16	30,00
			46,12		50,80
Toma teléfono cat. 3	Mecanismo	4538	8,67	4538	8,67
	Tapa	1407 20 89	5,20	1407 20 45	5,62
	Marco 1 elemento	1011 22 09	30,00	1011 22 16	30,00
			43,87		44,29
Toma simple RJ45 cat. 6a	Mecanismo	4554 01	21,00	4554 01	21,00
	Tapa	1407 20 89	5,20	1407 20 45	5,62
	Marco 1 elemento	1011 22 09	30,00	1011 22 16	30,00
			56,20		56,62
Toma doble RJ45 cat. 6a	Mecanismo	4555 01	27,00	4555 01	27,00
	Tapa	1409 20 89	5,20	1409 20 45	5,62
	Marco 1 elemento	1011 22 09	30,00	1011 22 16	30,00
			62,20		62,62
Toma TV	Mecanismo	4522 10	15,30	4522 10	15,30
	Tapa	1203 20 89	5,20	1203 20 45	5,62
	Marco 1 elemento	1011 22 09	30,00	1011 22 16	30,00
			50,50		50,92
Salida de hilos	Mecanismo	4470	10,00	4470	10,00
	Tapa	1019 20 89	5,20	1019 20 45	5,62
	Marco 1 elemento	1011 21 09	30,00	1011 22 16	30,00
			45,20		45,62
Tapa ciega	Mecanismo con tapa	1009 20 89	8,24	1009 20 45	8,78
	Marco 1 elemento	1011 22 09	30,00	1011 22 16	30,00
			38,24		38,78
Marco	2 elementos	1012 22 09	52,97	1012 22 16	52,97
	3 elementos	1013 22 09	69,74	1013 22 16	68,84
	4 elementos	1014 22 09	95,39	1014 22 16	94,16
	5 elementos	1015 22 09	130,01	1015 22 16	128,32

* toma SCHUKO con protección infantil y conexión por tornillos



Precios en (€)

		blanco polar, brillo		negro brillo		aluminio / blanco polar, brillo		aluminio / negro, brillo		acero / blanco polar, brillo		acero negro, brillo	
		Ref.	Precio	Ref.	Precio	Ref.	Precio	Ref.	Precio	Ref.	Precio	Ref.	Precio
Conmutador	Mecanismo	3876 00	15,30	3876 00	15,30	3876 00	15,30	3876 00	15,30	3876 00	15,30	3876 00	15,30
	Tapa central con manecilla	1001 20 89	16,54	1001 20 45	16,54	1001 20 74	45,00	1001 20 84	45,00	1001 20 14	55,00	1001 20 04	55,00
			31,84		31,84		60,30		60,30		70,30		70,30
Cruzmiento	Mecanismo	3877 00	29,99	3877 00	29,99	3877 00	29,99	3877 00	29,99	3877 00	29,99	3877 00	29,99
	Tapa central con manecilla	1001 20 89	16,54	1001 20 45	16,54	1001 20 74	45,00	1001 20 84	45,00	1001 20 14	55,00	1001 20 04	55,00
			46,53		46,53		74,99		74,99		84,99		84,99
Toma SCHUKO*	Mec. c/ tapa	4755 20 89	16,11	4755 20 45	16,11	4755 20 89	16,11	4755 20 45	16,11	4755 20 89	16,11	4755 20 45	16,11
	Marco 1 elemento	1011 20 89	5,45	1011 20 45	5,45	1011 20 74	35,00	1011 20 84	35,00	1011 20 14	45,00	1011 20 04	45,00
			21,56		21,56		51,11		51,11		61,11		61,11
Pulsador	Mecanismo	3846 00	19,89	3846 00	19,89	3846 00	19,89	3846 00	19,89	3846 00	19,89	3846 00	19,89
	Tapa central con manecilla	1001 20 89	16,54	1001 20 45	16,54	1001 20 74	45,00	1001 20 84	45,00	1001 20 14	55,00	1001 20 04	55,00
			36,43		36,43		64,89		64,89		74,89		74,89
Doble interruptor	Mecanismo	3875 00	18,77	3875 00	18,77	3875 00	18,77	3875 00	18,77	3875 00	18,77	3875 00	18,77
	Tapa central con manecilla	1001 20 89	16,54	1001 20 45	16,54	1001 20 74	45,00	1001 20 84	45,00	1001 20 14	55,00	1001 20 04	55,00
			35,31		35,31		63,77		63,77		73,77		73,77
Toma teléfono cat. 3	Mecanismo	4538	8,67	4538	8,67	4538	8,67	4538	8,67	4538	8,67	4538	8,67
	Tapa	1407 20 89	5,20	1407 20 45	5,62	1407 20 89	5,20	1407 20 45	5,62	1407 20 89	5,20	1407 20 45	5,62
	Marco 1 elem.	1011 20 89	5,45	1011 20 45	5,45	1011 20 74	35,00	1011 20 84	35,00	1011 20 14	45,00	1011 20 04	45,00
			19,32		19,74		48,87		49,29		58,87		59,29
Toma simple RJ45 cat. 6a	Mecanismo	4554 01	21,00	4554 01	21,00	4554 01	21,00	4554 01	21,00	4554 01	21,00	4554 01	21,00
	Tapa	1407 20 89	5,20	1407 20 45	5,62	1407 20 89	5,20	1407 20 45	5,62	1407 20 89	5,20	1407 20 45	5,62
	Marco 1 elem.	1011 20 89	5,45	1011 20 45	5,45	1011 20 74	35,00	1011 20 84	35,00	1011 20 14	45,00	1011 20 04	45,00
			31,65		32,07		61,20		61,62		71,20		71,62
Toma doble RJ45 cat. 6a	Mecanismo	4555 01	27,00	4555 01	27,00	4555 01	27,00	4555 01	27,00	4555 01	27,00	4555 01	27,00
	Tapa	1409 20 89	5,20	1409 20 45	5,62	1409 20 89	5,20	1409 20 45	5,62	1409 20 89	5,20	1409 20 45	5,62
	Marco 1 elem.	1011 20 89	5,45	1011 20 45	5,45	1011 20 74	35,00	1011 20 84	35,00	1011 20 14	45,00	1011 20 04	45,00
			37,65		38,07		67,20		67,62		77,20		77,62
Toma TV	Mecanismo	4522 10	15,30	4522 10	15,30	4522 10	15,30	4522 10	15,30	4522 10	15,30	4522 10	15,30
	Tapa	1203 20 89	5,20	1203 20 45	5,62	1203 20 89	5,20	1203 20 45	5,62	1203 20 89	5,20	1203 20 45	5,62
	Marco 1 elem.	1011 20 89	5,45	1011 20 45	5,45	1011 20 74	35,00	1011 20 84	35,00	1011 20 14	45,00	1011 20 04	45,00
			25,95		26,37		55,50		55,92		65,50		65,92
Salida de hilos	Mecanismo	4468	8,26	4468	8,26	4468	8,26	4468	8,26	4468	8,26	4468	8,26
	Tapa	1019 20 89	5,20	1019 20 45	5,62	1019 20 89	5,20	1019 20 45	5,62	1019 20 89	5,20	1019 20 45	5,62
	Marco 1 elem.	1011 20 89	5,45	1011 20 45	5,45	1011 20 74	35,00	1011 20 84	35,00	1011 20 14	45,00	1011 20 04	45,00
			18,91		19,33		48,46		48,88		58,46		58,88
Tapa ciega	Mec. con tapa	1009 20 79	17,55	1009 20 35	17,55	1009 20 79	17,55	1009 20 35	17,55	1009 20 79	17,55	1009 20 35	17,55
	Marco 1 elem.	1011 20 89	5,45	1011 20 45	5,45	1011 20 74	35,00	1011 20 84	35,00	1011 20 14	45,00	1011 20 04	45,00
			23,00		23,00		52,55		52,55		62,55		62,55
Marco	2 elementos	1012 20 89	15,42	1012 20 45	15,42	1012 20 74	59,40	1012 20 84	59,40	1012 20 14	109,51	1012 20 04	109,51
	3 elementos	1013 20 89	23,60	1013 20 45	23,60	1013 20 74	86,17	1013 20 84	86,17	1013 20 14	158,85	1013 20 04	158,85

* toma SCHUKO con protección infantil y conexión por tornillos

Precios en (€)





Nota: verificar referencias de esta serie que pueden instalarse en marcos
Instalación en caja de empotrar redonda

		cristal blanco polar		cristal negro	
					
		Ref.	Precio	Ref.	Precio
Conmutador	Mecanismo	3876 00	15,30	3876 00	15,30
	Tecla central con manecilla	1001 20 83	33,85 49,15	1001 20 55	33,85 49,15
Cruzamiento	Mecanismo	3877 00	29,99	3877 00	29,99
	Tecla central con manecilla	1001 20 83	33,85 63,84	1001 20 55	33,85 63,84
Toma SCHUKO*	Mec. c/ tapa	4755 20 89	16,11	4755 20 45	16,11
	Marco 1 elemento	1011 20 09	30,00 46,11	1011 20 16	30,00 46,11
Pulsador	Mecanismo	3846 00	19,89	3846 00	19,89
	Tecla central con manecilla	1001 20 83	33,85 53,74	1001 20 55	33,85 53,74
Doble interruptor	Mecanismo	3875 00	18,77	3875 00	18,77
	Tecla central con manecilla	1001 20 83	33,85 52,62	1001 20 55	33,85 52,62
Toma teléfono cat. 3	Mecanismo	4538	8,67	4538	8,67
	Tapa	1407 20 89	5,20	1407 20 45	5,62
	Marco 1 elemento	1011 20 09	30,00	1011 20 16	30,00
			43,87		44,29
Toma simple RJ45 cat. 6a	Mecanismo	4554 01	21,00	4554 01	21,00
	Tapa	1407 20 89	5,20	1407 20 45	5,62
	Marco 1 elemento	1011 20 09	30,00	1011 20 16	30,00
			56,20		56,62
Toma doble RJ45 cat. 6a	Mecanismo	4555 01	27,00	4555 01	27,00
	Tapa	1409 20 89	5,20	1409 20 45	5,62
	Marco 1 elemento	1011 20 09	30,00	1011 20 16	30,00
			62,20		62,62
Toma TV	Mecanismo	4522 10	15,30	4522 10	15,30
	Tapa	1203 20 89	5,20	1203 20 45	5,62
	Marco 1 elemento	1011 20 09	30,00	1011 20 16	30,00
			50,50		50,92
Salida de hilos	Mecanismo	4468	8,26	4468	8,26
	Tapa	1019 20 89	5,20	1019 20 45	5,62
	Marco 1 elemento	1011 20 09	30,00	1011 20 16	30,00
			43,46		43,88
Tapa ciega	Mecanismo con tapa	1009 20 79	17,55	1009 20 35	17,55
	Marco 1 elemento	1011 20 09	30,00 47,55	1011 20 16	30,00 47,55
Marco	2 elementos	1012 20 09	59,40	1012 20 16	59,40
	3 elementos	1013 20 09	86,17	1013 20 16	86,17

* toma SCHUKO con protección infantil y conexión por tornillos

Precios en (€)



Nota: verificar referencias de esta serie que pueden instalarse en marcos
Instalación en caja de empotrar redonda

		blanco polar		negro		blanco polar Porzellan made by Rosenthal		negro Porzellan made by Rosenthal	
									
		Ref.	Precio	Ref.	Precio	Ref.	Precio	Ref.	Precio
Interruptor / conmutador	Mecanismo	3876 00	15,30	3876 00	15,30	3876 00	15,30	3876 00	15,30
	Tapa central con manecilla	1647	10,20	1647 01	10,20	1647 69	35,90	1647 65	62,88
	Marco 1 elemento	1381 09	3,47	1381 01	3,47	1381 69	38,45	1381 65	38,45
			28,97		28,97		89,65		116,63
Cruzamiento	Mecanismo	3877 00	29,99	3877 00	29,99	3877 00	29,99	3877 00	29,99
	Tapa central con manecilla	1647	10,20	1647 01	10,20	1647 69	35,90	1647 65	62,88
	Marco 1 elemento	1381 09	3,47	1381 01	3,47	1381 69	38,45	1381 65	38,45
			43,66		43,66		104,34		131,32
Toma SCHUKO*	Mecanismo con tapa	4755	26,83	4755 01	26,83				
	Marco 1 elemento	1381 09	3,47	1381 01	3,47				
			30,30		30,30				
Pulsador	Mecanismo	3846 00	19,89	3846 00	19,89	3846 00	19,89	3846 00	19,89
	Tecla central con manecilla	1647	10,20	1647 01	10,20	1647 69	35,90	1647 65	62,88
	Marco 1 elemento	1381 09	3,47	1381 01	3,47	1381 69	38,45	1381 65	38,45
			33,56		33,56		94,24		121,22
Pulsador botón	Mecanismo	5104	21,52	5104 01	21,52				
	Pulsador	1225	7,75	1225 01	7,75				
	Marco 1 elemento	1381 09	3,47	1381 01	3,47				
			32,74		32,74				
Doble interruptor	Mecanismo	3875 00	18,77	3875 00	18,77	3875 00	18,77	3875 00	18,77
	Tecla	1647	10,20	1647 01	10,20	1647 69	35,90	1647 65	62,88
	Marco 1 elemento	1381 09	3,47	1381 01	3,47	1381 69	38,45	1381 65	38,45
			32,44		32,44		93,12		120,10
Toma teléfono cat. 3	Mecanismo	4538	8,67	4538	8,67				
	Tapa	1407	13,26	1407 01	13,26				
	Marco 1 elemento	1381 09	3,47	1381 01	3,47				
			25,40		25,40				
Toma simple RJ45 cat. 6a	Mecanismo	4554 01	21,00	4554 01	21,00				
	Tapa	1407	13,26	1407 01	13,26				
	Marco 1 elemento	1381 09	3,47	1381 01	3,47				
			37,73		37,73				
Toma doble RJ45 cat. 6a	Mecanismo	4555 01	27,00	4555 01	27,00				
	Tapa	1409	20,50	1409 01	20,50				
	Marco 1 elemento	1381 09	3,47	1381 01	3,47				
			50,97		50,97				
Toma TV	Mecanismo	4522 10	15,30	4522 10	15,30				
	Tapa	1064 20	20,50	1064 21	20,50				
	Marco 1 elemento	1381 09	3,47	1381 01	3,47				
			39,27		39,27				
Salida de hilos	Mecanismo	4468	8,26	4468	8,26				
	Tapa	1037	9,49	1037 01	9,49				
	Marco 1 elemento	1381 09	3,47	1381 01	3,47				
			21,22		21,22				
Tapa ciega	Mecanismo con tapa	1009 20	27,95	1009 21	27,95				
	Marco 1 elemento	1381 09	3,47	1381 01	3,47				
			31,42		31,42				
Marco	2 elementos	1381 29	9,79	1381 21	9,79				
	3 elementos	1381 39	14,79	1381 31	14,79				
	Intermedio	1381 59	16,12	1381 51	16,12				
	Final	1381 49	13,77	1381 41	13,77				

* toma SCHUKO con protección infantil y conexión rápida

Precios en (€)

Instalación en caja de empotrar redonda

		blanco polar		negro	
					
		Ref.	Precio	Ref.	Precio
Interruptor / Conmutador	Mecanismo	3876 00	15,30	3876 00	15,30
	Tapa central con manecilla	1647	10,20	1647 01	10,20
	Marco 1 elemento	1091	28,05	1091	28,05
			53,55		53,55
Cruzamiento	Mecanismo	3877 00	29,99	3877 00	29,99
	Tapa central con manecilla	1647	10,20	1647 01	10,20
	Marco 1 elemento	1091	28,05	1091	28,05
			68,24		68,24
Toma SCHUKO*	Mecanismo con tapa	4755	26,83	4755 01	26,83
	Marco 1 elemento	1091	28,05	1091	28,05
			54,88		54,88
Pulsador	Mecanismo	3846 00	19,89	3846 00	19,89
	Tecla central con manecilla	1647	10,20	1647 01	10,20
	Marco 1 elemento	1091	28,05	1091	28,05
			58,14		58,14
Pulsador botón	Mecanismo	5104	21,52	5104 01	21,52
	Pulsador	1225	7,75	1225 01	7,75
	Marco 1 elemento	1091	28,05	1091	28,05
			57,32		57,32
Doble interruptor	Mecanismo	3875 00	18,77	3875 00	18,77
	Tecla	1647	10,20	1647 01	10,20
	Marco 1 elemento	1091	28,05	1091	28,05
			57,02		57,02
Toma teléfono cat. 3	Mecanismo	4538	8,67	4538	8,67
	Tapa	1407	13,26	1407 01	13,26
	Marco 1 elemento	1091	28,05	1091	28,05
			49,98		49,98
Toma simple RJ45 cat. 6a	Mecanismo	4554 01	21,00	4554 01	21,00
	Tapa	1407	13,26	1407 01	13,26
	Marco 1 elemento	1091	28,05	1091	28,05
			62,31		62,31
Toma doble RJ45 cat. 6a	Mecanismo	4555 01	27,00	4555 01	27,00
	Tapa	1409	20,50	1409 01	20,50
	Marco 1 elemento	1091	28,05	1091	28,05
			75,55		75,55
Toma TV	Mecanismo	4522 10	15,30	4522 10	15,30
	Tapa	1064 20	20,50	1064 21	20,50
	Marco 1 elemento	1091	28,05	1091	28,05
			63,85		63,85
Salida de hilos	Mecanismo	4468	8,26	4468	8,26
	Tapa	1037	9,49	1037 01	9,49
	Marco 1 elemento	1091	28,05	1091	28,05
			45,80		45,80
Tapa ciega	Mecanismo con tapa	1009 20	27,95	1009 21	27,95
	Marco 1 elemento	1091	28,05	1091	28,05
			56,00		56,00
Marco	2 elementos	1102	50,59	1102	50,59
	Intermedio	1093 00	35,80	1093 00	35,80
	Final	1092 00	33,05	1092 00	33,05

* toma SCHUKO con protección infantil y conexión rápida

Precios en (€)

Instalación en caja de empotrar redonda

Estándar de calidad lumina 2

La gama lumina 2 está disponible en dos colores - blanco y blanco polar - y es la respuesta a las necesidades del mercado actual, que exige soluciones más económicas donde la relación coste/beneficio es un factor decisivo.

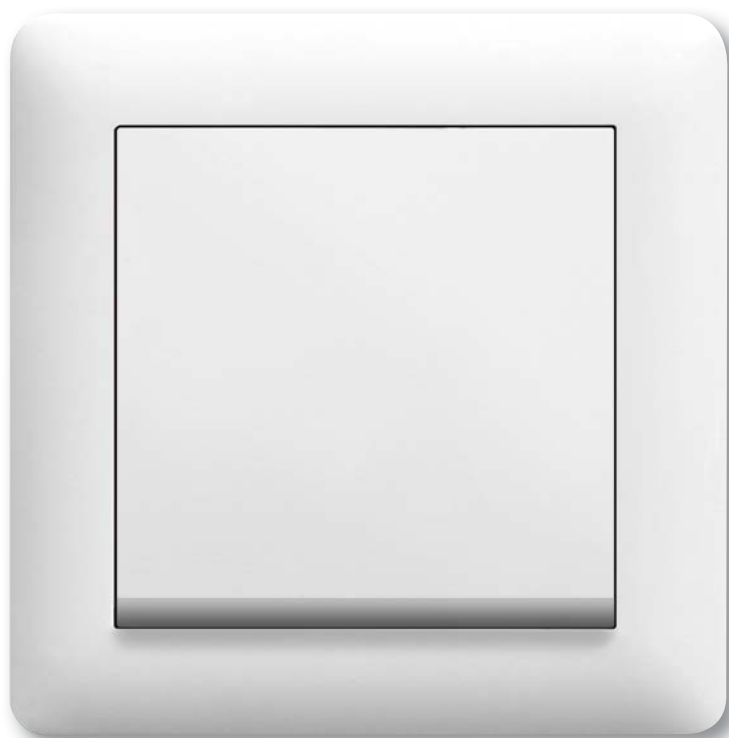

lumina 2

pág.

ventajas	36
concepto modular	38
interruptores	40
marcos, toma Schuko	41
tomas telefonía, datos	42
tomas RTV, SAT	43
NUEVO reguladores, toma altavoz, accesorios, otros...	44

lumina 2 estándar de calidad

lumina 2 es la solución económica y con la mejor calidad para sus proyectos. Amplia oferta compuesta por interruptores simples, dobles, triples, con indicador, reguladores de luz rotativos, tomas Schuko...

Su concepto modular, permite con tan sólo 2 referencias obtener un producto completo. El uso de marcos múltiples permite el montaje de hasta 5 elementos.

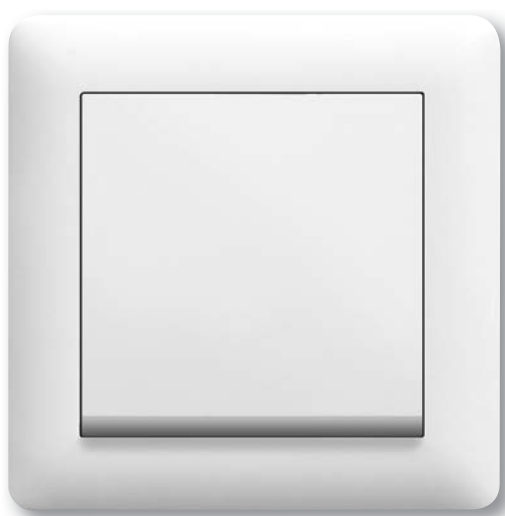

Ventajas:

-
- 2 colores disponibles: blanco polar brillo, blanco brillo
-
- Marco de hasta 5 elementos
-
- Garras en todos los mecanismos
-
- Embalaje individual
-

Características técnicas:

-
- | | |
|--|-------------------------------|
| - 2 referencias para completar el producto | - Mecanismo con tecla y marco |
|--|-------------------------------|
-
- | | |
|-------------|------------|
| - Bastidor: | - Metálico |
|-------------|------------|
-
- | | |
|---------------------------|---------------|
| - Productos certificados: | - VDE y AENOR |
|---------------------------|---------------|
-

Más ventajas



01

Diseño moderno y estético. Ideal para su uso casi en cualquier lugar.

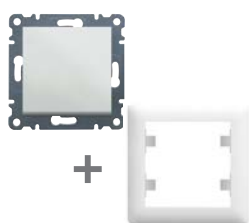

02

Montaje rápido y fácil. En dos pasos se monta el producto componiéndolo según las necesidades requeridas. Mecanismo con tecla y marco.



03

El bastidor metálico garantiza un montaje seguro y sin deteriorarse sobre superficies irregulares.



04

Embalaje individual de cada elemento de la serie lumina 2 que protege el producto durante el transporte y el montaje en el lugar de la obra.



05

Perfecta fijación ya que todos los mecanismos incorporan garras.



06

Productos certificados VDE y AENOR.

Concepto modular, sólo 2 referencias

Aquí le mostramos cómo puede montar un producto completo a partir de dos elementos.

01 Seleccione mecanismo



conmutador
blanco polar
Ref: WL0020



conmutador
blanco polar
Ref: WL0020



toma Schuko
blanco polar
Ref: WL1060



conmutador
blanco polar
Ref: WL0020



toma Schuko
blanco polar
Ref: WL1060

02 Elija el marco

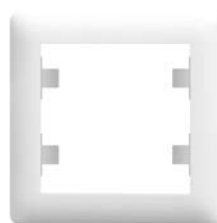

marco 1 elemento
blanco polar
Ref: WL5010



marco vertical 2 elementos
blanco polar
Ref: WL5120



marco horizontal 2 elementos
blanco polar
Ref: WL5220

03 **Producto completo**

=

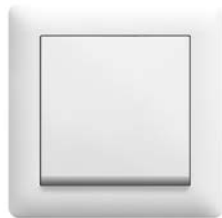

conmutador
blanco polar
lumina 2

=



conmutador con toma Schuko
blanco polar vertical
lumina 2

=



conmutador con toma Schuko
blanco polar horizontal
lumina 2

Interruptores simples



Interruptor

Descripción	Referencia	Emb.	Precio (€)
Blanco polar	WL0010	12	3,72
Blanco	WL0011	12	3,72

WL0010

- unipolar
- conectores rápidos



Conmutador

Descripción	Referencia	Emb.	Precio (€)
Blanco polar	WL0020	12	4,58
Blanco	WL0021	12	4,58

WL0020

- unipolar
- conectores rápidos



Cruzamiento

Descripción	Referencia	Emb.	Precio (€)
Blanco polar	WL0030	12	9,37
Blanco	WL0031	12	9,37

WL0030

- con conectores rápidos



Interruptor bipolar

Descripción	Referencia	Emb.	Precio (€)
Blanco polar	WL0060	12	10,58
Blanco	WL0061	12	10,58

WL0060

- 2 circuitos eléctricos independientes
- con conectores rápidos

Interruptores dobles



Interruptor doble

Descripción	Referencia	Emb.	Precio (€)
Blanco polar	WL0040	12	6,31
Blanco	WL0041	12	6,31

WL0040

- con conectores rápidos



Conmutador doble

Descripción	Referencia	Emb.	Precio (€)
Blanco polar	WL0050	12	7,28
Blanco	WL0051	12	7,28

WL0050

- con bornes de tornillos



Interruptor triple

Descripción	Referencia	Emb.	Precio (€)
Blanco polar	WL0070	12	9,46
Blanco	WL0071	12	9,46

WL0070

- 3 circuitos eléctricos independientes
- con bornes de tornillos

Pulsador



Pulsador

Descripción	Referencia	Emb.	Precio (€)
Blanco polar	WL0110	12	5,49
Blanco	WL0111	12	5,49

WL0110

- pulsador unipolar
- con conectores rápidos

Mecanismo con indicador luminoso



Interruptor

Descripción	Referencia	Emb.	Precio (€)
Blanco polar	WL0210	12	4,31
Blanco	WL0211	12	4,31

WL0210

- unipolar
- lámpara de neón incluida



Conmutador con indicador luminoso

Descripción	Referencia	Emb.	Precio (€)
Blanco polar	WL0220	12	5,31
Blanco	WL0221	12	5,31

WL0220

- unipolar
- lámpara de neón incluida



Interruptor doble con indicador luminoso

Descripción	Referencia	Emb.	Precio (€)
Blanco polar	WL0240	12	7,31
Blanco	WL0241	12	7,31

WL0240

- unipolar
- lámpara de neón incluida



Pulsador con indicador luminoso

Descripción	Referencia	Emb.	Precio (€)
Blanco polar	WL0410	12	9,88
Blanco	WL0411	12	9,88

WL0410

- unipolar
- lámpara de neón incluida

Mecanismo para persiana



Interruptor para persiana

Descripción	Referencia	Emb.	Precio (€)
Blanco polar	WL0310	12	15,50
Blanco	WL0311	12	15,50

WL0310

- con bloqueo eléctrico para evitar la conexión simultánea en ambas direcciones
- unipolar
- terminales de conexión rápida



Pulsador para persiana

Descripción	Referencia	Emb.	Precio (€)
Blanco polar	WL0320	12	15,76
Blanco	WL0321	12	15,76

WL0320

- con bloqueo eléctrico para evitar la conexión simultánea en ambas direcciones
- unipolar, contacto NA
- terminales de conexión rápida

Nota: todos los interruptores de esta página son 10 AX, 250 V~

Esquemas de conexionado pág. 250

Marcos y adaptadores



WL5010

Marcos blanco polar

Descripción	Referencia	Emb.	Precio (€)
1 elemento	WL5010	12	0,94

vertical:

2 elementos	WL5120	25	1,70
3 elementos	WL5130	20	2,73
4 elementos	WL5140	25	4,87
5 elementos	WL5150	6	6,70

horizontal:

2 elementos	WL5220	25	1,70
3 elementos	WL5230	20	2,73
4 elementos	WL5240	25	4,87
5 elementos	WL5250	6	6,70



WL5011

Marcos blanco

Descripción	Referencia	Emb.	Precio (€)
1 elemento	WL5011	12	0,94

vertical:

2 elementos	WL5121	25	1,70
3 elementos	WL5131	20	2,73
4 elementos	WL5141	25	4,87
5 elementos	WL5151	6	6,70

horizontal:

2 elementos	WL5221	25	1,70
3 elementos	WL5231	20	2,73
4 elementos	WL5241	25	4,87
5 elementos	WL5251	6	6,70

Tomas



WL1060

Toma Schuko

Descripción	Referencia	Emb.	Precio (€)
Blanco polar	WL1060	12	4,03
Blanco	WL1061	12	4,03

16 A, 250 V~

- bipolar con conexión a tierra
- protección infantil
- con bornes de tornillos
- productos certificados VDE y AENOR



WL1160

Toma Schuko con tapa

Descripción	Referencia	Emb.	Precio (€)
Blanco polar	WL1160	12	7,83
Blanco	WL1161	12	7,83

16 A, 250 V~

- bipolar con conexión a tierra
- protección infantil
- con bornes de tornillos
- opción IP44 con kit de sellado ref. WL7023
- productos certificados VDE y AENOR



WL7023

Kit de sellado IP44 toma de corriente

Descripción	Referencia	Emb.	Precio (€)
Kit de sellado	WL7023	18	3,21

- Para alcanzar un grado de protección IP44 en tomas de corriente con conexión a tierra y tapa

NUEVO

Toma de corriente francesa



WL1040

Descripción	Referencia	Emb.	Precio (€)
Blanco polar	WL1040	12	6,50
Blanco	WL1041	12	6,50

Tomas telefonía RJ11



Toma teléfono simple

Descripción	Referencia	Emb.	Precio (€)
Blanco polar	WL2010	12	9,56
Blanco	WL2011	12	9,56

WL2010

- 1 x toma RJ11 cat. 3



Toma teléfono doble

Descripción	Referencia	Emb.	Precio (€)
Blanco polar	WL2020	12	17,50
Blanco	WL2021	12	17,50

WL2020

- 2 x toma RJ11 cat.3

Tomas telefonía/datos



Toma RJ11 + RJ45

Descripción	Referencia	Emb.	Precio (€)
Blanco polar	WL2210	12	18,04
Blanco	WL2211	12	18,04

WL2210

- 1 x toma RJ11 cat. 3
- 1 x 1 x toma RJ45 cat. 5 UTP con protección contra el polvo

Tomas datos RJ45 simples



RJ45 cat. 5e UTP

Descripción	Referencia	Emb.	Precio (€)
Blanco polar	WL2110	12	14,50
Blanco	WL2111	12	14,50

WL2110



RJ45 cat. 6 UTP

Descripción	Referencia	Emb.	Precio (€)
Blanco polar	WL2150	12	16,00
Blanco	WL2151	12	16,00

WL2150



RJ45 cat. 6 FTP

Descripción	Referencia	Emb.	Precio (€)
Blanco polar	WL2170	12	20,00
Blanco	WL2171	12	20,00

WL2170

Soporte Keystone Jack



Soporte doble para Keystone Jack

Descripción	Referencia	Emb.	Precio (€)
Blanco polar	WL2320	12	4,00
Blanco	WL2321	12	4,00

WL2320

- para montaje de módulos RJ45 estándar Keystone Jack
- se suministra con 1 espacio ciego

Soporte para fibra óptica

Soporte FO duplex-SC

Descripción	Referencia	Emb.	Precio (€)
Blanco polar	WL2410	12	7,73
Blanco	WL2411	12	7,73

- consultar disponibilidad

Tomas RJ45 dobles



2xRJ45 cat 5e UTP

Descripción	Referencia	Emb.	Precio (€)
Blanco polar	WL2120	12	29,00
Blanco	WL2121	12	29,00

WL2120



2xRJ45 cat 6 UTP

Descripción	Referencia	Emb.	Precio (€)
Blanco polar	WL2160	12	34,00
Blanco	WL2161	12	34,00

WL2160



2xRJ45 cat 6 FTP

Descripción	Referencia	Emb.	Precio (€)
Blanco polar	WL2180	12	41,00
Blanco	WL2181	12	41,00

WL2180

- todas las tomas RJ45 incorporan protección contra el polvo

Tomas de antena



Toma RTV

Descripción	Referencia	Emb.	Precio (€)
Blanco polar	WL3010	12	17,83
Blanco	WL3011	12	17,83

WL3010

Frecuencia 5-862 MHz;
Impedancia 75 W
Frecuencia TV 5-68 | 118-862 MHz;
Frecuencia R 88-108 MHz;
Atenuación: TV \leq 2 dB; R \leq 1.5 dB

- para instalaciones individuales analógicas y digitales DVB-T
- para la recepción de señal terrestre y por cable
- para estructura en árbol
- tensión DC en salida TV
- bornes de tornillos



Toma RTV de paso

Descripción	Referencia	Emb.	Precio (€)
Blanco polar	WL3020	12	17,83
Blanco	WL3021	12	17,83

WL3020

Frecuencia 5-862 MHz;
Impedancia 75 W
Frecuencia TV 5-68 | 118-862 MHz;
Frecuencia R 88-108 MHz;
Atenuación: TV \leq 2 dB; R \leq 1.5 dB
R 10.8-10.9 dB;
IN->OUT:1.1 dB;

- para instalaciones individuales analógicas y digitales DVB-T
- para la recepción de señal terrestre y por cable
- para estructura en árbol y línea principal
- con bornes de tornillos



Toma RTV/SAT

Descripción	Referencia	Emb.	Precio (€)
Blanco polar	WL3110	12	19,32
Blanco	WL3111	12	19,32

WL3110

Frecuencia 5-2200 MHz;
Impedancia 75 W
Frecuencia TV 10-68 | 125-862 MHz;
Frecuencia R 88-108 MHz;
Frecuencia SAT 950-2200 MHz;
Atenuación: TV \leq 2 dB; R \leq 1.7 dB;
SAT \leq 2.6 dB

- para instalaciones individuales analógicas y digitales DVB-T
- para la recepción de señal terrestre y de satélite
- tensión DC en salida SAT



Toma RTV / SAT de paso

Descripción	Referencia	Emb.	Precio (€)
Blanco polar	WL3120	12	19,32
Blanco	WL3121	12	19,32

WL3120

Frecuencia 5-2400 MHz;
Impedancia 75 W
Frecuencia TV 5-70 | 120-862 MHz;
Frecuencia R 88-108 MHz;
Frecuencia SAT 950-2400 MHz;
Atenuación: TV 10 dB; R 12 dB;
SAT 8/6 dB;
IN->OUT: 3.7-7 dB;

- para instalaciones individuales analógicas y digitales DVB-T
- para la recepción de señal terrestre y de satélite
- tensión DC en salida SAT
- para estructura en árbol y línea principal
- una entrada común
- bornes de tornillos

Accesorios



Tapa RTV

Descripción	Referencia	Emb.	Precio (€)
Blanco polar	WL6320	18	3,80
Blanco	WL6321	18	3,80

WL6320

- con posibilidad de romper los tapones ciegos de la entrada SAT

Nota: Para tomas Televés

- Los bastidores de toma de televisión son diferentes al resto de la gama lumina 2

Reguladores



Regulador rotativo

Descripción	Referencia	Emb.	Precio (€)
Blanco polar	WL4010	12	48,29
Blanco	WL4011	12	48,29

WL4010

lámparas incandescentes 60 – 600 W;
lámparas halógenas 230V 60 – 600 W;
250 V~, 50 Hz

- con mando rotativo
- con protección contra cortocircuitos y sobrecargas (fusibles)
- con indicador LED
- con bornes de tornillos

NUEVO

Regulador pulsación



Descripción	Referencia	Emb.	Precio (€)
Blanco polar	WL4030	12	48,29
Blanco	WL4031	12	48,29

WL4030

- cargas resistivas 60-300W
- 250 V~, 50Hz

Marco intermedio



Marco intermedio 50x50

Descripción	Referencia	Emb.	Precio (€)
Blanco polar	WL5310	12	1,01
Blanco	WL5311	12	1,01

WL5310

- para tapa timbre 1474 02 (blanco)
1474 09 (blanco polar)
- para toma fibra óptica berker 1480 02 (blanco)

Adaptador 45 x 45

NUEVO

Adaptador 45 x 45



Descripción	Referencia	Emb.	Precio (€)
Blanco polar	WL2510	12	3,52
Blanco	WL2511	12	3,52

WL2510

Tapa ciega



Tapa ciega

Descripción	Referencia	Emb.	Precio (€)
Blanco polar	WL7010	12	5,94
Blanco	WL7011	12	5,94

WL7010

- El bastidor de la tapa ciega es diferente al resto de la gama lumina 2

Toma altavoz



Toma altavoz

Descripción	Referencia	Emb.	Precio (€)
Blanco polar	WL3310	12	9,50
Blanco	WL3311	12	9,50

WL3310

Tarjetero hotel

NUEVO

Tarjetero hotel

Descripción	Referencia	Emb.	Precio (€)
Blanco polar	WL0510	12	19,75
Blanco	WL0511	12	19,75

Teclas con pictogramas

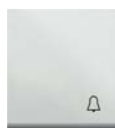

Tecla con el símbolo "campana"

Descripción	Referencia	Emb.	Precio (€)
Blanco polar	WL6010	18	1,50
Blanco	WL6011	18	1,50

WL6010



Tecla con el símbolo "luz"

Descripción	Referencia	Emb.	Precio (€)
Blanco polar	WL6020	18	1,50
Blanco	WL6021	18	1,50

WL6020



Tecla con el símbolo "escalera"

Descripción	Referencia	Emb.	Precio (€)
Blanco polar	WL6030	18	1,50
Blanco	WL6031	18	1,50

WL6030

Teclas c/ pictogramas e indicador luminoso



Tecla con el símbolo "campana"

Descripción	Referencia	Emb.	Precio (€)
Blanco polar	WL6110	18	1,65
Blanco	WL6111	18	1,65

WL6110



Tecla con el símbolo "luz"

Descripción	Referencia	Emb.	Precio (€)
Blanco polar	WL6120	18	1,65
Blanco	WL6121	18	1,65

WL6120



Tecla con el símbolo "escalera"

Descripción	Referencia	Emb.	Precio (€)
Blanco polar	WL6130	18	1,65
Blanco	WL6131	18	1,65

WL6130

- montaje de las teclas en mecanismos con indicador luminoso

Cajas de superficie

NUEVO

Caja principal



WL5410

Descripción	Referencia	Emb.	Precio (€)
Blanco polar	WL5410	12	4,86
Blanco	WL5411	12	4,86

NUEVO

Caja módulo extensión

Descripción	Referencia	Emb.	Precio (€)
Blanco polar	WL5420	12	3,47
Blanco	WL5421	12	3,47

- tornillos y tacos incluidos

Series de mecanismos Series berker

El sistema modular con mayor número de estéticas y tipos de materiales.

La amplitud de formas, colores y materiales (cristal, acero, aluminio, porcelana, hormigón,...) permite aunar los conceptos de Calidad, Funcionalidad y Diseño. Con esta amplísima gama de series de mecanismos, siempre encontrará la solución más adecuada para la decoración de cualquier ambiente, en todas sus funcionalidades, tanto en mecanismo convencional y electrónico como en control y gestión de edificios.



series berker

pág.

	concepto modular	48
	mecanismos, ventajas	50
	tomas de corriente, ventajas	53
	mecanismos	54
	berker S.1	64
	berker B.3	66
	berker B.7	68
NUEVO	berker S.1 / B.3 / B.7	70
NUEVO	berker Q.1	82
NUEVO	berker Q.3	84
NUEVO	berker Q.7	86
NUEVO	berker Q.1 / Q.3 / Q.7	88
	berker K.1	98
	berker K.5	100
NUEVO	berker K.1 / K.5	102
	berker Arsys	110
	berker R.1	122
	berker R.3	124
NUEVO	berker R.1 / R.3	130
	Serie R.classic	134
	Serie 1930	136
	Serie 1930 Porzellan made by Rosenthal	138
	Serie Glas	140
	Serie R.classic / 1930 / Glas	142

Concepto modular de la aplicación...

Aquí le mostramos cómo puede montar un producto completo a partir de tres elementos: mecanismo, marco y tecla/tapa

01

Aplicación

Seleccione mecanismo
en el capítulo de:
Mecanismos modulares

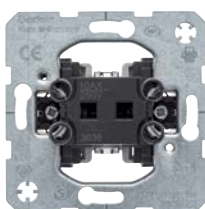

Conmutador

ej.: conmutador
n° de referencia: 3036

Mecanismos electrónicos



Regulador

ej.: Mecanismo regulador rotativo
n° de referencia: 2830 10

Mecanismos electrónicos



Toma USB

ej.: mecanismo toma USB
n° de referencia: 2600 09

02

Elija el diseño del marco
en el capítulo:
berker B.3



ej.: marco 1 elemento aluminio/blanco polar
n° de referencia: 1011 39 04

berker K.1



ej.: marco 1 elemento blanco polar
n° de referencia: 1313 70 09

berker S.1



ej.: marco blanco polar, brillo para 1 interruptor
n° de referencia: 1011 99 09

... al producto completo

03

Encuentre una tecla o tapa

en el capítulo:

berker S.1/B.1/B.3/B.7

Teclas y tapas



ej.: tecla blanco polar, mate
nº de referencia: 1620 19 09

Producto completo



Interruptor
Diseño: berker B.3

berker K.1/K.5

Teclas y mecanismos centrales



ej.: tapa mando rotativo blanco polar, brillo
nº de referencia: 1135 70 09



Dimmer mando rotativo
Diseño: berker K.1

berker S.1/B.1/B.3/B.7 Glas

Teclas y mecanismos centrales



ej.: tapa toma USB blanco polar, brillo
nº de referencia: 1760 19 09



Toma USB
Diseño: berker S.1

Beneficios del mecanismo

Como inventor del sistema modular, berker dispone de un único mecanismo para distintas estéticas. Los mecanismos actuales se dejan en la pared. Sólo se sustituyen las estéticas. Incluso si se desea un interruptor de control o un interruptor iluminado, el mecanismo siempre es el mismo. Esto significa para Ud. lo siguiente:

- No hay mecanismos equivocados en la instalación
- Stock mínimo
- Satisfacción del cliente a largo plazo

Funcionalidad y diseño

El diseño modular probado y testeado y el ángulo extremadamente plano de sólo 3.5° hacen que el interruptor se vea muy plano en la pared. Para que la instalación sea fácil se creó el concepto de garras Flexolift.

Las garras se ajustan a ras y se ven forzadas automáticamente a su posición cuando se sueltan. En la parte posterior del interruptor se encuentra un grabado láser del diagrama del circuito, el símbolo gráfico, y la longitud de tramo de conductor sin aislamiento necesario para la conexión. En la parte frontal, destaca la referencia del mecanismo para poder identificarlo de manera muy sencilla. Una protección alrededor de los tornillos garra previene daños a los conductores. Las teclas son guiadas principalmente con la ayuda de monturas en el mecanismo, haciendo que el mecanismo sea más fácil de usar.



- Datos marcados en la parte frontal

Referencia, características técnicas, fecha de fabricación



- Bastidor de alta calidad

Resistente, sin esquinas puntiagudas y con opciones de atornillado adicionales



- Diseño de bastidor óptimo

Marcado para alineación precisa durante la instalación



- Angulo de 3,5° de basculación

Para una apariencia plana



- Diseño modular

Apto para todos los tipos de teclas



- Amplio espacio y fácil acceso

a los tornillos para las garras de sujeción

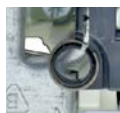

- Asiento preciso de las teclas sobre el mecanismo



- Posición del indicador luminoso

Puede utilizarse como indicador o luz de orientación



- Tecla de desconexión con palanca

Mayor facilidad para la desconexión de los cables conductores

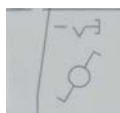

- Datos marcados en la parte trasera

Esquema y símbolo de conexión, longitud de tramo de conductor sin aislamiento necesario para la conexión

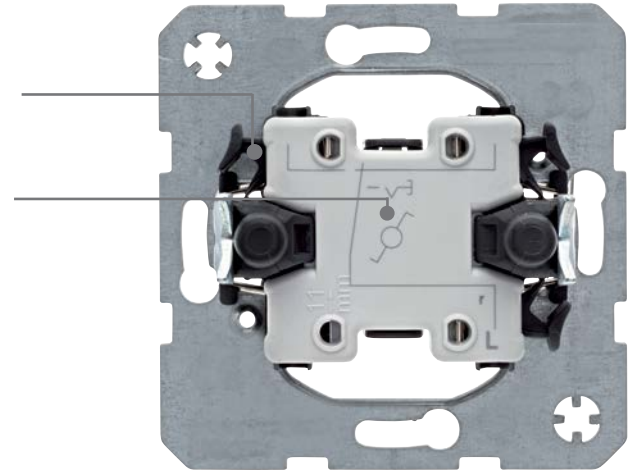
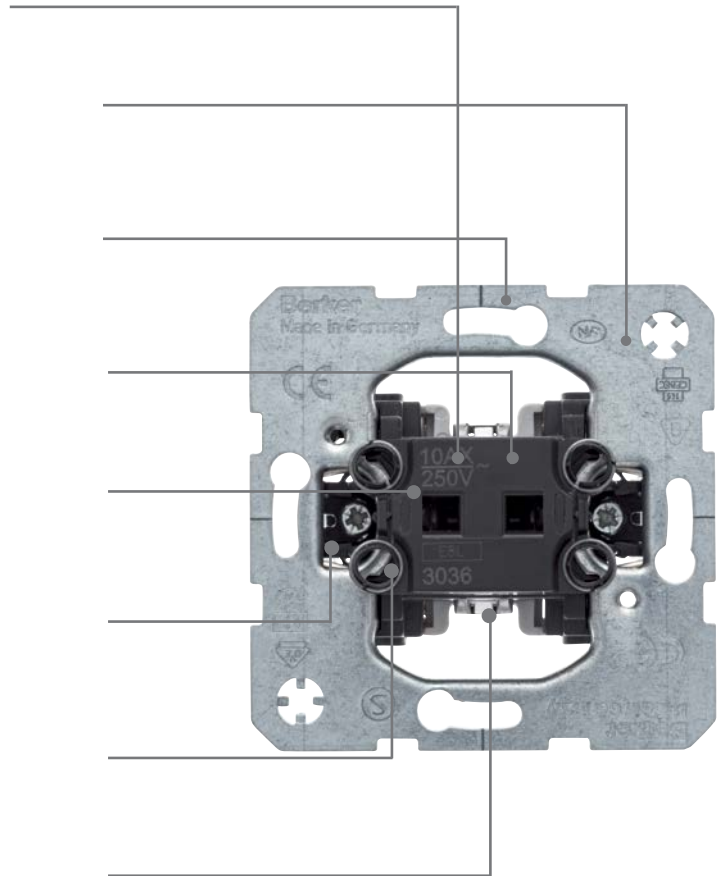

- Protección de los cables conductores

Los tornillos para el despliegue de las garras de sujeción están provistos de una protección que impide el daño de los cables conductores



- Garras Flexolift®

Las garras se abaten al desmontar el interruptor, quedando perfectamente plegadas



- Profundidad mínima de instalación

con el máximo espacio para la instalación del mecanismo en paredes huecas



Ventajas de las tomas de corriente

berker ha estado produciendo tomas de corriente durante más de 90 años. Miles de ellas a diario utilizando materiales de alta calidad, con diseños exclusivos.

Hemos utilizado nuestros años de experiencia y de ideas innovadoras para optimizar los pequeños detalles de nuestras tomas de corriente, con el fin de facilitar el trabajo diario a nuestros clientes.

- Más fácil
- Más rápido
- Más seguro
- Stock mínimo

Diseño compacto y base resistente

El bastidor con una superficie de alta calidad es muy resistente, no tiene esquinas puntiagudas y se le ha modificado el contorno para que la alineación y el atornillado durante la instalación sean considerablemente más fáciles.

Los conductores ahora son más fáciles de insertar y atornillar dentro de los terminales.

La geometría de garra abierta previene daños a los conductores durante el ensamblaje.

La posibilidad de un voltaje parasitario en el bastidor se previene con una separación voltaica. Y las garras Flexolift se retraen completamente dentro de la base.

Los tornillos estrella proveen un máximo agarre a los destornilladores.



- **Bastidor de alta calidad**
Sin esquinas puntiagudas y puntos adicionales de sujeción para paredes huecas



- **Diseño de bastidor óptimo**
Marcado para facilitar el alineado durante la instalación



- **Marcas de prueba en la base**
para visibilidad en cada fase del montaje



- **Pulsadores fáciles de usar**
para sacar rápido los conductores durante el desmontaje



- **Tornillos de las garras**
para el enroscado óptimo 3 veces más rápido



- **Etiqueta en el bastidor**
para el etiquetado claro de los circuitos eléctricos



- **Tornillos estrella en la tapa**
para el perfecto agarre durante el ensamblaje



- **Marcado en la base**
Longitud de tramo de conductor sin aislamiento necesario para la conexión



- **Toma cerrada robusta**
para una instalación segura



- **Separación voltaica del bastidor**
para trabajar de forma segura sin voltaje parasitario



- **Geometría de la garra**
que previene daños a los conductores durante la instalación



- **Las garras en la base**
de forma que completamente retraídas son fáciles de instalar y colocar en la caja



- **Diseño terminal optimizado**
para fácil inserción de los conductores



- **Terminales con tornillos**
para la conexión rápida y segura de posicionamiento de los conductores. Sólo en tomas marcadas con terminales con tornillos

- **Referencia independiente de la tapa**

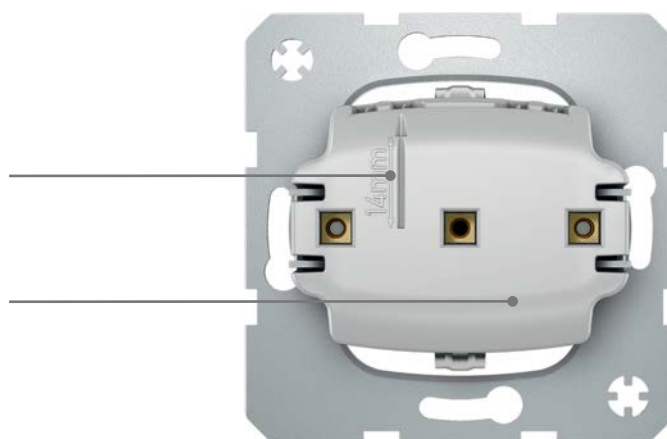
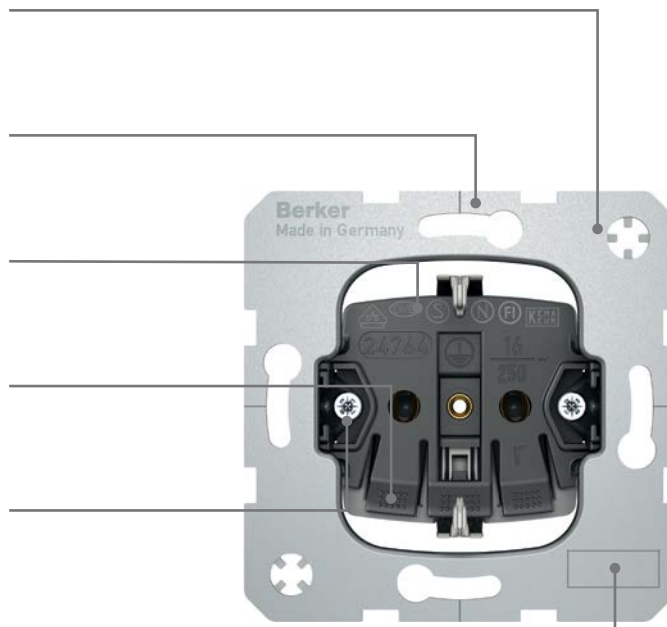

Interruptores

Mecanismos de mando



3036

Descripción	Referencia	Emb.	Precio (€)
Interruptor on/off 10AX, 250V	3031	10	3,67
Conmutador 10AX, 250V	3036	10	4,18
Cruzamiento 10AX, 250V	3037	10	8,69

Conmutador 10AX, 250V pared hueca	3036 50	10	8,16
--	---------	----	-------------

* Sin garras



3032

Interruptor bipolar on/off 10AX, 250V	3032	10	9,18
Interruptor bipolar on/off 16AX, 250V	3032 12*	10	19,99

Conmutador bipolar 10AX, 250 V	67 3039 09*	10	23,46
---------------------------------------	-------------	----	--------------

Interruptor tripolar on/off 16AX, 400V	3033 03*	10	15,61
---	----------	----	--------------

Doble interruptor on/off 10AX, 250V	3035	10	5,51
--	------	----	-------------

Doble interruptor on/off 10AX, 250V para pared hueca	3035 50	10	12,34
---	---------	----	--------------

* Sin garras

Doble conmutador, terminales de entrada aislados	3038 08	10	13,67
---	---------	----	--------------

Interruptor 3x1 polo off 16AX, 400V	63 3023*	10	22,13
--	----------	----	--------------

Pulsador izqdo. + conmutador derecho	5038 08 01	10	11,05
---	------------	----	--------------

Pulsador dcho. + conmutador izqdo.	5038 08 02	10	11,05
---	------------	----	--------------

* Con bornes a tornillo



3966

Interruptor de tirador

Descripción	Referencia	Emb.	Precio (€)
Conmutador 10AX, 250V	3966	10	14,18

Interruptor rotativo bipolar

Descripción	Referencia	Emb.	Precio (€)
20A para 2,5-4 mm²	3862*	10	77,52
25A para 2,5-6 mm²	3862 01	10	87,52

* Con bornes a tornillo



3861 01

Interruptor rotativo 3 posiciones 16A, 250V

Descripción	Referencia	Emb.	Precio (€)
Posición 0-1-2-3	3861	10	25,50
Posición 2-1-3	3861 01	10	43,15

Con bornes a tornillo



3826 10

Interruptor llave para cerradura perfil semicilíndrico

Descripción	Referencia	Emb.	Precio (€)
Interup./conmutador bipolar 10A, 250V	3826 10*	10	112,40

* Con bornes a tornillo

Pulsadores

Pulsadores 10A, 250 V



5031

Descripción	Referencia	Emb.	Precio (€)
Unipolar NA	5031	10	4,50

Unipolar, 1 entrada línea y 2 salidas (NA o NC)	5036	10	6,53
--	------	----	-------------

Unipolar, 3 salidas 1NA + 2 contactos auxiliares libre de potencial	5031 01	10	8,36
--	---------	----	-------------

Unipolar, dos circuitos diferentes alternativos a/ entrada-salida NA, b/entrada-salida NC	5032 03	10	14,24
--	---------	----	--------------

Unipolar NA para pared hueca	5031 50	10	9,28
-------------------------------------	---------	----	-------------



5035

Unipolar, terminal de entrada común, salidas 2NA = doble pulsador	5035	10	8,36
--	------	----	-------------

Unipolar, dos circuitos diferentes alternativos 1 NA, 1 NC	5035 01	10	12,23
---	---------	----	--------------

Unipolar, dos circuitos diferentes alternativos 2 NA	5035 03	10	12,75
---	---------	----	--------------

Doble conmutado, 2 circuitos con 6 bornes de conexión: 2 entradas y 2 salidas por entrada NA o NC	5038 08*	10	23,26
--	----------	----	--------------

* Con bornes a tornillo



5051 02

Tarjetero hotel

Descripción	Referencia	Emb.	Precio (€)
Pulsador, NA	5051 02	10	8,87

Pulsador conmutador	5056 01	10	8,87
----------------------------	---------	----	-------------

Pulsador, NA con contactos auxiliares	5051 03	10	13,26
--	---------	----	--------------

Pulsador, 1 NA, 1 NC entradas indepen.	5052 01	10	21,52
---	---------	----	--------------



3956 19

Pulsador de tirador

Descripción	Referencia	Emb.	Precio (€)
Pulsador conmutador 10A, 250V	3956 19	10	19,18



3856 20

Pulsador llave para cerradura perfil semicilíndrico

Descripción	Referencia	Emb.	Precio (€)
Pulsador conmutador	3856 20	10	97,82

• Con bornes a tornillo

Mecanismos para persianas



3035 20

Mecanismos para persianas

Descripción	Referencia	Emb.	Precio (€)
Interruptor 10A, 250 V	3035 20	10	12,65



3841

Mecanismos para persianas rotativos

Descripción	Referencia	Emb.	Precio (€)
Interruptor 10A, 250V	3841*	10	21,93
Interruptor bipolar 10A, 250V	3842*	10	31,01
Accesorio. Anillo conversión en pulsador	1861	10	2,86

* Con bornes a tornillo



3822 10

Mecanismos para persianas de llave

Descripción	Referencia	Emb.	Precio (€)
Interruptor bipolar 10A, 250V para cerradura de perfil semicilíndrico	3822 10*	10	84,05
Interruptor de llave 10A, 250V	3851*	10	24,17
Interruptor de llave bipolar 10A, 250V	3852*	10	32,03

* Con bornes a tornillo



5035 20

Mecanismos pulsadores para persianas

Descripción	Referencia	Emb.	Precio (€)
Pulsador 10A, 250V	5035 20	10	12,04
Pulsador 1 entrada y 4 salidas NA terminal de entrada para cerradura de perfil semicilíndrico	5034 04*	10	15,81
Pulsador de llave para cerradura de perfil semicilíndrico	3831 10*	10	78,03
Pulsador bipolar, de llave para cerradura de perfil semicilíndrico	3832 10*	10	84,05

* Con bornes a tornillo

Tomas TV / Audio / Video



4573 09

Altavoces, conectores

Descripción	Referencia	Emb.	Precio (€)
Toma altavoz simple. Blanco polar	4572 09	10	19,69
Toma altavoz simple. Antracita	4572 05	10	19,69
Toma altavoz doble. Blanco polar	4573 09	10	21,42
Toma altavoz doble. Antracita	4573 05	10	21,42



4505 02

2 tomas altavoces estéreo HiFi	4505 02	10	44,57
2 tomas estéreo para altavoces	4505 01	10	11,73
Conector altavoces	1800	10	4,08
Conector audio/video (RCA)	1989	1	46,61
Conector video	1992	1	24,48
Conector VGA	1994	1	91,80
Conector S-video	1993	1	41,82
Conector Tapa ciega. Blanco polar	1990	1	4,13



4502 10

Tomas de TV

2 tomas TV-R indep. derivación Única	4502 10	10	15,30
3 tomas TV-R indep. derivación Única	4522 10	1	15,30
3 tomas TV-R indep. Intermedias	4593	1	36,65
4 tomas TV-R indep. derivación Única	4594 10	1	20,00

Toma Schuko

Descripción	Referencia	Emb.	Precio (€)
Mecanismo SCHUKO	7141 34	10	4,24

- Es necesario añadir las tapas según la serie
- Conexión por tornillo
- Productos certificados VDE y AENOR

Tomas USB de carga 230V



2600 09

Descripción	Referencia	Emb.	Precio (€)
Antracita, mate	2600 05	1	96,07
Blanco polar, mate	2600 09	1	96,07

- Carga de dispositivos móviles vía cable USB (2 x tipo A)

Serie	Referencia	Tapa toma USB
S/B	68 1033 89 82	blanco brillo
	68 1033 89 89	blanco polar brillo
	68 1033 19 09	blanco polar mate
	68 1033 14 04	aluminio
	68 1033 16 06	antracita
Q.x	68 1033 60 82	blanco
	68 1033 60 84	aluminio
	68 1033 60 86	antracita
	68 1033 60 89	blanco polar
K.x	68 1034 70 09	blanco polar
	68 1034 70 06	antracita
	68 1034 70 03	aluminio
	68 1034 70 04	acero
R.x	68 1033 20 89	blanco polar
	68 1033 20 45	negro
Arsys	68 1035 00 02	blanco
	68 1035 00 69	blanco polar
	68 1035 00 01	marrón
	68 1034 00 01	bronce
	68 1034 00 04	acero

Datos / Telecomunicaciones

Tomas informáticas y teléfono



4538

Descripción	Referencia	Emb.	Precio (€)
Toma telefónica UAE simple 8 cables	4538	10	8,67

- Para conectores RJ11, RJ12, RJ45
- Cat. 3



4562

Descripción	Referencia	Emb.	Precio (€)
Toma telefónica UAE doble	4562	10	18,05

- Para conexión telefónica normal y ADSL (2 hilos), RDSI (4 hilos)
- Para conectores RJ11, RJ12 y RJ45 (2 tomas en paralelo x 8 (4) polos
- Cat. 3

Descripción	Referencia	Emb.	Precio (€)
Toma RJ45 simple Categoría 6 clase E (8 polos)	4554 01	10	21,00



4555 01

Descripción	Referencia	Emb.	Precio (€)
Toma RJ45 doble Categoría 6 clase E (8/8 polos)	4555 01	10	27,00



4588

Descripción	Referencia	Emb.	Precio (€)
Toma UAE RJ45 doble Categoría real 6a, clase EA (8/8 pin)	4588	1	38,33



1985

Toma mini jack

Descripción	Referencia	Emb.	Precio (€)
8 polos RJ45 cat. 3	1980	1	17,24
8 polos RJ45 cat. 5e	1984	1	23,56
8 polos RJ45 cat. 6	1985	1	27,34



4540 01

Soporte para toma modular jack

Descripción	Referencia	Emb.	Precio (€)
1 toma color rojo	4540 01	10	6,22
2 tomas color rojo	4541 01	10	6,22

- Dimensiones aprox: 15,5 x 19,5 mm
- Tapas con protector de suciedad
- Jack modular: AMP, Asyco, Dätwyler, Dr. Ing. Sieger, EFB Electronic Erni, Hubbell, ICS, Leoni Kerpen, Nexans, Radiall, Rutenbeck, Setec Telegärtner, ZA-Tec, Abitana



4541 05

1 toma color blanco	4540 02	10	8,98
2 tomas color blanco	4541 05	10	8,98

- Dimensiones aprox: 14,9 x 20,7 mm
- Tapas con protector de suciedad
- Jack modular: AMP, Brand-Rex, CobiNet, EFB Electronic Tomas AMP serie 110 Connect cat.3, 5, 5e y 6e

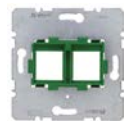

4541 04

1 toma color verde	4540 04	10	6,22
2 tomas color verde	4541 04	10	6,22

- Dimensiones aprox: 17 x 18 mm
- Tapas con protector de suciedad
- Jack modular: Commscope-Systemax, gigaSpeed, PowerSUM, ref. MGS300BH-X, M1BH-X, MPS100E-X, MGS500-X, MGS400-X, MGS600
- Tomas Commscope-Systemax cat. 5 y 6



4541 07

2 tomas color marrón	4541 07	10	8,98
-----------------------------	---------	----	-------------

- Dimensiones aprox: 14,9 x 19,5 mm
- Tapas con protector de suciedad
- Jack modular: Harting, Krone, Reichle&De-Massari, Thomas & Betts
- Acopladores fibra óptica: 3M, Krone, mvk
- Tomas Krone cat. 5, 5e y 6



4541 09

2 tomas color naranja	4541 09	10	8,02
------------------------------	---------	----	-------------

- Dimensiones aprox: 14,9 x 19,5 mm
- Tapas con protector de suciedad
- Jack modular: BTR, Dätwyler



4505

Soporte para toma altavoces

Descripción	Referencia	Emb.	Precio (€)
2 tomas BNC o altavoces	4505	10	11,03

*Tabla de tomas RJ45 compatibles en nuestra web: www.hager.es/berker

WLAN



4582

WLAN

Descripción	Referencia	Emb.	Precio (€)
WLAN accesorio	4582	1	416,67
WLAN accesorio, PoE	4583	1	500,91

LED señalización blanco



2953 89 82

LED señalización blanco

Descripción	Referencia	Emb.	Precio (€)
S/B, blanco brillo	2953 89 82		76,52
S/B, blanco polar brillo	2953 89 89		76,52
S/B, blanco polar mate	2953 19 09		76,52
S/B, antracita	2953 16 06		81,20
S/B, aluminio	2953 14 04		86,88



2953 70 09

Q.x, blanco	2953 60 82		76,52
Q.x, blanco polar	2953 60 89		76,52
Q.x, antracita	2953 60 86		81,20
Q.x, aluminio	2953 60 84		81,20



2953 20 89

K.x, blanco polar	2953 70 09		81,05
K.x, antracita	2953 70 06		81,20
K.x, aluminio	2953 70 03		86,88
K.x, acero inoxidable	2953 70 04		86,88

R.x, blanco polar brillo	2953 20 89		81,05
R.x, negro brillo	2953 20 45		81,20

- Para señalar información o avisos
- Luminosidad ajustable o potenciómetro
- Control vía interruptor separado
- Se pueden insertar films con símbolos
- Color blanco frío
- Estética incorporada

LED señalización rojo/verde

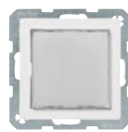

2952 89 82

LED señalización rojo/verde

Descripción	Referencia	Emb.	Precio (€)
S/B, blanco brillo	2952 89 82		85,19
S/B, blanco polar brillo	2952 89 89		85,19
S/B, blanco polar mate	2952 19 09		85,19
S/B, antracita	2952 16 06		89,87
S/B, aluminio	2952 14 04		95,55

Q.x, blanco	2952 60 82		85,19
Q.x, blanco polar	2952 60 89		85,19
Q.x, antracita	2952 60 86		89,87
Q.x, aluminio	2952 60 84		89,87

K.x, blanco polar	2952 70 09		89,72
K.x, antracita	2952 70 06		89,87
K.x, aluminio	2952 70 03		95,55
K.x, acero inoxidable	2952 70 04		95,55

R.x, blanco polar	2952 20 89		89,72
R.x, negro	2952 20 45		89,87

- Para señalización de control de accesos
- Activación de verde y rojo mediante interruptores separados
- Incluye 2 films de «no molestar/limpiar» y «espere/pase»
- Estética incorporada

LED señalización RGB



2951 89 82

LED señalización RGB

Descripción	Referencia	Emb.	Precio (€)
S/B, blanco brillo	2951 89 82		109,17
S/B, blanco polar brillo	2951 89 89		109,17
S/B, blanco polar mate	2951 19 09		109,17
S/B, antracita	2951 16 06		110,03
S/B, aluminio	2951 14 04		110,03

Q.x, blanco	2951 60 82		109,46
Q.x, blanco polar	2951 60 89		109,46
Q.x, antracita	2951 60 86		111,07
Q.x, aluminio	2951 60 84		111,07

K.x, blanco polar	2951 70 09		109,17
K.x, antracita	2951 70 06		110,16
K.x, aluminio	2951 70 03		110,37
K.x, acero inoxidable	2951 70 04		110,37

R.x, blanco polar	2951 20 89		115,58
R.x, negro	2951 20 45		115,83

- Para señalar información o avisos
- Luminosidad ajustable vía potenciómetro
- Colores: blanco frío, blanco cálido, azul, naranja, rojo, verde, magenta
- Secuencia de colores gestionable vía pulsador
- La secuencia puede pararse en cualquier posición vía del pulsador
- Se pueden insertar films con símbolos
- Estética incorporada

Film para LED señalización rojo/verde



1905 80 11

Film para LED rojo/verde

Descripción	Referencia	Emb.	Precio (€)
Símbolo no molestar/limpiar	1905 80 11		9,20
Símbolo espere/pase	1905 80 12		9,20
Redondo, símbolo no molestar/limpiar	1905 80 13		9,20
Redondo, símbolo espere/pase	1905 80 14		9,20

Film para LED señalización



1905 80 03

LED señalización

Descripción	Referencia	Emb.	Precio (€)
Hombre	1905 80 01		8,20
Mujer	1905 80 02		8,20
Silla de ruedas	1905 80 03		8,20
Escaleras	1905 80 04		8,20
Ascensor	1905 80 05		8,20

Redondo, hombre	1905 80 06		8,20
Redondo, mujer	1905 80 07		8,20
Redondo, silla de ruedas	1905 80 08		8,20
Redondo, escaleras	1905 80 09		8,20
Redondo, ascensor	1905 80 10		8,20

Señalización



5101 10

Mecanismo piloto pulsador escalera lámparas E10

Descripción	Referencia	Emb.	Precio (€)
Pulsador NA	5101	10	6,22
Pulsador NA. Contacto separado para señalización	5101 10	10	10,20

- Con bornes a tornillo



1601

Lámparas E10

Descripción	Referencia	Emb.	Precio (€)
Neón 230V 1,35 mA	1601	100	5,30
LED blanco	1678	10	14,80
LED rojo	1678 01	10	9,59
LED amarillo	1678 02	10	9,59
LED verde	1678 03	10	21,38
LED azul	1678 04	10	14,06



1280

Tapa transparente para botón luminoso E10

Descripción	Referencia	Emb.	Precio (€)
Transparente	1280	10	2,75
Rojo	1281	10	2,75
Amarillo	1282	10	2,75
Verde	1283	10	2,75



1279 02

Tapa transparente pulsador luminoso E10 Ø 26,5mm

Descripción	Referencia	Emb.	Precio (€)
Transparente	1279 02	10	4,18
Rojo	1279	10	4,18
Verde	1279 03	10	4,18



5131 02

Mecanismo piloto para lámparas E14

Descripción	Referencia	Emb.	Precio (€)
Piloto 250V	5131 02	10	10,91



1610 03

Lámparas E14, 230 V

Descripción	Referencia	Emb.	Precio (€)
Lámpara incandescente para piloto para tapa plana	1610 03	10	8,36
Lámpara incandescente para piloto para tapa alta	1610 13	10	8,36
LED blanco	1679	10	19,97
LED rojo	1679 01	10	12,75
LED amarillo	1679 02	10	12,75
LED verde	1679 03	10	19,98
LED azul	1679 04	10	24,11



1679



1220

Tapa transparente para botón luminoso E14

Descripción	Referencia	Emb.	Precio (€)
Transparente plana	1220	10	3,57
Transparente alta	1230	10	3,57
Rojo alta	1231	10	3,57
Verde alta	1232	10	3,57

Salida de cables



4470

Descripción	Referencia	Emb.	Precio (€)
Salida de cables	4470	10	10,00
Salida de cables con espacio adicional	4468	10	8,26

- Diámetro máx. cable 9 mm

Temporizadores



2041

Interruptor temporizado

Descripción	Referencia	Emb.	Precio (€)
Bipolar, 15 min 16AX, 250V	2040	1	105,98
Bipolar, 120 min 16AX, 250V	2041	1	147,70

Sistemas hospitalarios



1061

Descripción	Referencia	Emb.	Precio (€)
Mecanismo toma doble equipotencial	1061*	10	39,07
Mecanismo toma equipotencial modular	4604	1	30,09
Clavija para tomas equipotenciales	4605	1	24,07

- * Con bornes a tornillo

Timbre

Descripción	Referencia	Emb.	Precio (€)
Timbre	BBH01	1	33,90

Serie	Acabado	Tapa	Marco intermedio
S/B	blanco	1474 02	1109 89 82
	blanco polar, mate	1474 19 09	1109 19 09
	blanco polar, brillo	1474 09	1109 89 89
	aluminio	1474 14 04	1109 14 04
	antracita	1474 16 06	1109 16 06
Q.1/Q.3	blanco	1474 02	1109 60 82
	blanco polar	1474 19 09	1109 60 89
	antracita	1474 16 06	1109 60 86
	aluminio	1474 14 04	1109 60 84
K.1	blanco polar	1474 09	1108 70 09
	antracita	1474 16 06	1108 70 06
K.5	acero	1474 04	1108 70 04
	aluminio	1474 14 04	1108 70 03
ARSYS	blanco	1474 02	1108 00 02
	blanco polar	1474 09	1108 00 69
	acero	1474 04	1108 90 04

Atención: Tapa no disponible para las series R.1 y R.3

Accesorios



1818

Descripción	Referencia	Emb.	Precio (€)
Cerradura de perfil semicilíndrico con diferentes cierres	1818	1	34,78

- Incluye 3 llaves

Cerradura de perfil semicilíndrico con el mismo cierre

Referencia	Emb.	Precio (€)
1818 01	1	41,82

- Incluye 3 llaves



1913

Prolongador de garras para mecanismos empotrados

Referencia	Emb.	Precio (€)
1913	50	1,22

Garra de sustitución

Referencia	Emb.	Precio (€)
1914	20	1,22



1849

Tapas de protección

Descripción	Referencia	Emb.	Precio (€)
Para tomas de corriente e interruptores	1849	10	1,12



1021 12

Base autoextinguible para instalación de zócalos

Descripción	Referencia	Emb.	Precio (€)
Base autoex. Zócalos 1 elemento	1021 12	10	4,69
Base autoex. Zócalos 2 elementos	1021 22	10	7,34
Base autoex. Zócalos 3 elementos	1021 32	10	12,95



1111 00

Accesorios placas de montaje

Descripción	Referencia	Emb.	Precio (€)
Tapa ciega aplicaciones especiales	1111 00	10	3,47
Tapa jack XLR. Serie C	1111 05	10	4,49
Tapa conector D-subminiatura 9 polos	1111 03	10	4,49
Conector Subminiatura 15 polos	1111 02	10	4,49
Conector Subminiatura 25 polos	1111 01	10	4,49
Para jack modular	1111 16	10	4,49
Para 2 jack modular	1112 18	10	4,49
Para 2 conectores fibra óptica Duplex SC	1112 21	10	4,49

Lámparas



1676 01

Lámpara incandescente con terminal -N

Descripción	Referencia	Emb.	Precio (€)
Marrón 6V, 35 mA	1676	10	6,32
Amarilla 12V, 35 mA	1676 02	10	6,32
Verde 24V, 35 mA	1676 01	10	6,32
Roja 48V, 35 mA	1676 03	10	10,20

- Para interruptores, conmutadores, cruzamientos, interruptores bipolares, mecanismos dobles, pulsadores



1680

Lámpara LED

Descripción	Referencia	Emb.	Precio (€)
LED negro c/terminal -N, 230V 0,9 mA	1680	1	14,11
LED blanco, 230 V, 1 mA	1686	10	14,11
LED negro, 230 V, 0,4 mA	1686 01	10	14,11
LED azul, 12-48V, 0,2-0,9 mA	1687	10	14,11

- Para mecanismos dobles ref. 3035, 6130 35



1675 04

Lámpara de Neón

Descripción	Referencia	Emb.	Precio (€)
Carcasa gris terminal -N, 230V, 1mA	1675	10	3,16
Carcasa naranja terminal -N, 230V, 0,4mA	1675 04	10	5,10
Carcasa gris terminal -N, 230V, 1 mA	1605 10	10	3,16
Carcasa naranja terminal -N, 230V, 0,4mA	1605 14	10	3,16

- Para interruptores, conmutadores, cruzamientos, interruptores bipolares, mecanismos dobles, pulsadores excepto referencias: 503404, 503808

Carcasa gris, 230V, 0,9 mA, int. 2P 16A	1600 02	10	7,24
Carcasa transparente 400V, 0,5 mA, int. 3P	1600	10	8,57

Lámparas



Las referencias marcadas con este símbolo son adecuadas para instalaciones IP44 y protección estanca utilizando el kit de sellado.

		Unidad LED con Terminal - N	Lámparas incandescentes con terminal - N	Unidad LED con Terminal - N	Lámpara de neón con Terminal - N	Lámpara de neón con Terminal - N	Lámpara de neón 230 V~	Lámpara LED	Lámpara de neón
		1687	1676 6V 1676 02 12V 1676 01 24V 1676 03 48V	1686 1 mA 1686 01 0,4 mA	1675 1 mA 1675 04 0,4 mA	1605 10 1 mA 1605 14 0,4 mA	1600 02	1680	1600
Descripción	Ref.	12...48V	8...48 V	230 V					400 V
Interruptor									
Conmutador	3036 3036 50 3076 25	●	●	●	●	●			
Cruzamiento	3037	●	●	●	●	●			
Interruptor bi/tripolar									
Interruptor bipolar 10 AX	3032 3172 05	●	●	●	●	●			
Interruptor bipolar 16 AX	3032 12						●		
Interruptor tripolar 16 AX	3033 03								●
Interruptor / conmutador doble									
Doble interruptor	3035 3035 50	● ¹⁾	● ¹⁾	●	● ¹⁾	● ¹⁾		●	
Doble conmutador	3038 08						● ¹⁾		
Pulsadores									
Pulsador NA	5031 5031 50	●	●	●	●	●			
Pulsador, 1 entrada línea y 2 salidas	5036 5076 05	●	●	●	●	●			
Pulsador unipolar, 3 salidas NA + 2 contactos aux.	5031 01 5071 05	●	●	●	●	●			
Pulsador unipolar, 2 circuitos diferentes alternativos	5032 03	●	●	●	●	●			
Pulsador múltiple									
Unipolar 2 contactos NA	5035 5035 03	● ¹⁾	● ¹⁾	●	● ¹⁾	● ¹⁾			
Unipolar 1 NO + 1 Abierto	5035 01	● ¹⁾	● ¹⁾	●	● ¹⁾	● ¹⁾			
Doble conmutado	5038 08						● ¹⁾		
Pulsador doble persianas	5034 04						● ¹⁾		
Interruptor de tirador									
Conmutador	3966					●			
Interruptor bipolar	3962					●			
Interruptor de emergencia									
Conmutador	3566 05	●	●	●	●	●			
Interruptor bipolar	3562 05	●	●	●	●	●			
Combinación IP44									
Interruptor 10A + schuko con tapa	4781 05	●	●	●	●	●			
Tarjetero hotel									
Pulsador NA	5051 02	●	●	●	●	●			
Pulsador conmutador	5056 01	●	●	●	●	●			
Pulsador, NA con contactos auxiliares	5051 03	●	●	●	●	●			

1) Sólo iluminación

Tabla de selección de reguladores

Modelo de regulador Tipo de carga	Reguladores de corte de fase ascendente estándar	Reguladores de corte de fase ascendente de baja tensión	Reguladores de corte de fase descendente	Regulador de luz universal	Reguladores de velocidad
Estándar Lámparas incandescentes	R coincide > combinación válida	R coincide > combinación válida	R coincide > combinación válida	R coincide > combinación válida	
Lámparas incandescentes y halógenas de 230 V	R coincide > combinación válida	R coincide > combinación válida	R coincide > combinación válida	R coincide > combinación válida	
Lámparas halógenas de 12 V con transformador convencional regulable		L coincide > combinación válida		L coincide > combinación válida	
Lámparas halógenas de 12 V con transformador electrónico con funciones capacitivas			C coincide > combinación válida	C coincide > combinación válida	
Lámparas halógenas de 12 V con transformador electrónico con funciones inductivas		L coincide > combinación válida		L coincide > combinación válida	
Lámparas halógenas de 12 V con transformador electrónico con funciones inductivas o capacitivas		L coincide > combinación válida	C coincide > combinación válida	L coincide > combinación válida	
Motores					M coincide > combinación válida

Reguladores rotativos



Regulador LED rotativo apagado suave pulsación **40-500W** 2873 1 **62,80**

- Para cargas incandescentes, halógenas HV
- Transformadores convencionales y HBV
- LED regulables 230 V. 3...100W
- LV LED con ferrottransformadores 20...100VA
- Corte de fase ascendente



Regulador rotativo **60-400W** 2819 01 10 **25,50**

- 230V CA 50Hz
- Para cargas incandescentes y halógenas HV
- Apagado por giro
- Punto único de regulación
- Corte de fase ascendente



Regulador rotativo pulsación **60-400W** 2830 10 1 **34,43**
60-600W 2860 10 1 **40,60**

- 230V CA 50/60-Hz
- Para cargas incandescentes y halógenas HV
- Punto único de regulación
- Conmutador y cruzamiento desde otros puntos con ref. 3036 y 3037
- Corte de fase ascendente



Regulador rotativo interruptor **20-500W** 2866 10 1 **55,42**

- 230V CA 50/60-Hz
- Para cargas incandescentes y halógenas HV
- Transformadores convencionales y HBV
- Punto único de regulación
- Conmutador y cruzamiento desde otros puntos con ref. 3036 y 3037
- Corte de fase ascendente



Regulador rotativo con apagado suave pulsación **60-600W** 2875 1 **66,91**
100-1000W 2885* 1 **162,59**

- 230V CA 50Hz
- Para cargas incandescentes y halógenas HV
- Corte de fase ascendente

* Corte de fase descendente



Regulador universal con apagado suave **50-420W** 2861 10 1 **129,54**

- 230V CA 50/60Hz
- Para cargas incandescentes, halógenas HV
- Transformadores electrónicos y convencionales
- Corte de fase ascendente o descendente en función del tipo de carga. Autoaprendizaje.



Regulador universal aux. con apagado suave 2862 10 1 **68,09**

- 230V CA 50/60Hz
- Como unidad de extensión de la ref. 2861 10
- Número máximo de unidades de extensión = 5

Regulador de motores

Descripción	Referencia	Emb.	Precio (€)
 Regulador de motores	2968 01	1	99,45
<ul style="list-style-type: none"> • 230/240V CA 50/60Hz • Corriente nominal máx: 0,1-2,7A 			

2968 01

Regulador DALI

Descripción	Referencia	Emb.	Precio (€)
 Regulador rotativo DALI	2897	1	122,40
Regulador rotativo DALI con unidad de alimentación integrada	2898	1	173,40

2897

Regulador 1-10V

Descripción	Referencia	Emb.	Precio (€)
 Regulador rotativo 1-10V con apagado suave 6A	2891 10	1	41,82
Regulador rotativo 1-10V con apagado suave 2A	2896 10	1	40,70
Regulador 1-10V, montaje en superf	2872	1	108,50

2891 10

Interruptor de protección diferencial

Descripción	Referencia	Emb.	Precio (€)
 Interruptor de protección diferencial	2844	1	122,40

2844

Mecanismos temporizadores

Descripción	Referencia	Emb.	Precio (€)
 Mecanismo pulsador con relé temporizador	2948 10	1	111,29
<ul style="list-style-type: none"> • 230/240V 50/60Hz • Cargas incandescentes (1500W) • Halógenas (300W) • Transformadores electrónicos (1500W) • Transformadores convencionales (1000VA) 			

2948 10

Descripción	Referencia	Emb.	Precio (€)
 Mecanismo interruptor horario temporizado	2948	1	114,79
<ul style="list-style-type: none"> • 230 50/60Hz • Cargas incandescentes y halógenas (1000W) • Transformadores electrónicos (750W) • Transformadores convencionales (500VA) 			

2948

Accesorios

Descripción	Referencia	Emb.	Precio (€)
 Mecanismo adaptador para sensores	7594 10 01	10	8,68
<ul style="list-style-type: none"> • Familia 96 			

7594 10 01

Descripción	Referencia	Emb.	Precio (€)
 Sensor T° suelo /sensor remoto	161	1	24,79

161



berker S.1

berker S.1 es sinónimo de “estándar”, incluso en sus formas. Porque esta gama de interruptores ha fijado los estándares reales de simplicidad, funcionalidad e intemporalidad. Y, porque, gracias a estas cualidades, se ha desarrollado naturalmente para convertirse en una opción estándar para edificios de oficinas y residenciales.



Design
Award
Winner
2000





berker B.3

Los colores enriquecen la vida, y berker B.3 prácticamente los incorpora en su diseño. Permite encontrar casi cualquier combinación gracias a las múltiples variantes de color para el marco y las teclas.





berker B.7

Hay que dar a cada interruptor el marco adecuado: berker B.7 está disponible, además de en variantes con el marco de cristal, en plástico, acero inoxidable y aluminio. En estos materiales, se puede combinar perfectamente con los sensores berker TS y berker B.IQ



Marcos berker B.3



1011 39 04

Marcos aluminio / blanco polar

Descripción	Referencia	Emb.	Precio (€)
1 elemento	1011 39 04	10	11,37
2 elementos	1012 39 04	10	18,48
3 elementos	1013 39 04	10	25,50
4 elementos	1014 39 04	2	38,63
5 elementos	1015 39 04	2	47,71

- Montaje vertical y horizontal



1011 30 04

Marcos aluminio / antracita

Descripción	Referencia	Emb.	Precio (€)
1 elemento	1011 30 04	10	11,37
2 elementos	1012 30 04	10	18,48
3 elementos	1013 30 04	10	25,50
4 elementos	1014 30 04	2	38,63
5 elementos	1015 30 04	2	47,71

- Montaje vertical y horizontal



1013 30 46

Marcos aluminio, dorado / blanco polar

Descripción	Referencia	Emb.	Precio (€)
1 elemento	1011 30 46	10	16,32
2 elementos	1012 30 46	10	26,52
3 elementos	1013 30 46	10	36,62
4 elementos	1014 30 46	2	55,49
5 elementos	1015 30 46	2	68,54

- Montaje vertical y horizontal



1011 30 16

Marcos aluminio, dorado / antracita

Descripción	Referencia	Emb.	Precio (€)
1 elemento	1011 30 16	10	16,32
2 elementos	1012 30 16	10	26,52
3 elementos	1013 30 16	10	36,62
4 elementos	1014 30 16	2	55,49
5 elementos	1015 30 16	2	68,54

- Montaje vertical y horizontal



1011 30 25

Marcos aluminio, negro / blanco polar

Descripción	Referencia	Emb.	Precio (€)
1 elemento	1011 30 25	10	16,32
2 elementos	1012 30 25	10	26,52
3 elementos	1013 30 25	10	36,62
4 elementos	1014 30 25	2	55,49
5 elementos	1015 30 25	2	68,54

- Montaje vertical y horizontal



1011 30 05

Marcos aluminio, negro / antracita

Descripción	Referencia	Emb.	Precio (€)
1 elemento	1011 30 05	10	16,32
2 elementos	1012 30 05	10	26,52
3 elementos	1013 30 05	10	36,62
4 elementos	1014 30 05	2	55,49
5 elementos	1015 30 05	2	68,54

- Montaje vertical y horizontal



1011 30 21

Marcos aluminio, marrón / blanco polar

Descripción	Referencia	Emb.	Precio (€)
1 elemento	1011 30 21	10	16,32
2 elementos	1012 30 21	10	26,52
3 elementos	1013 30 21	10	36,62
4 elementos	1014 30 21	2	55,49
5 elementos	1015 30 21	2	68,54

- Montaje vertical y horizontal



1011 30 01

Marcos aluminio, marrón / antracita

Descripción	Referencia	Emb.	Precio (€)
1 elemento	1011 30 01	10	16,32
2 elementos	1012 30 01	10	26,52
3 elementos	1013 30 01	10	36,62
4 elementos	1014 30 01	2	55,49
5 elementos	1015 30 01	2	68,54

- Montaje vertical y horizontal

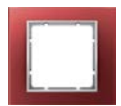

1011 30 22

Marcos aluminio, rojo / blanco polar

Descripción	Referencia	Emb.	Precio (€)
1 elemento	1011 30 22	10	16,32
2 elementos	1012 30 22	10	26,52
3 elementos	1013 30 22	10	36,62
4 elementos	1014 30 22	2	55,49
5 elementos	1015 30 22	2	68,54

- Montaje vertical y horizontal

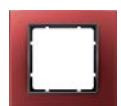

1011 30 12

Marcos aluminio, rojo / antracita

Descripción	Referencia	Emb.	Precio (€)
1 elemento	1011 30 12	10	16,32
2 elementos	1012 30 12	10	26,52
3 elementos	1013 30 12	10	36,62
4 elementos	1014 30 12	2	55,49
5 elementos	1015 30 12	2	68,54

- Montaje vertical y horizontal



1309 30 16

Marco para teclados KNX

Descripción	Referencia	Emb.	Precio (€)
Aluminio/blanco polar	1309 39 04	1	26,08
Aluminio/antracita	1309 30 04	1	26,08
Aluminio dorado/blanco polar	1309 30 46	1	44,88
Aluminio dorado/antracita	1309 30 16	1	29,58
Aluminio negro/blanco polar	1309 30 25	1	29,58
Aluminio negro/antracita	1309 30 05	1	29,58
Aluminio marrón/blanco polar	1309 30 21	1	29,58
Aluminio marrón/antracita	1309 30 01	1	29,58
Aluminio rojo/blanco polar	1309 30 22	1	29,58
Aluminio rojo/antracita	1309 30 12	1	29,58

- No es válido para montajes en superficie
- Montaje vertical

Cajas para montaje en superficie



1041 19 09

Cajas para montaje en superficie

Descripción	Referencia	Emb.	Precio (€)
1 elemento			
Blanco polar, mate	1041 19 09	10	14,58
Antracita	1041 16 06	10	11,63

- Profundidad instalación 37 mm



1042 19 09

2 elementos			
Blanco polar, mate	1042 19 09	5	18,16
Antracita	1042 16 06	5	19,89

- Profundidad instalación 37 mm



1043 19 09

3 elementos			
Blanco polar, mate	1043 19 09	5	29,17
Antracita	1043 16 06	5	31,52

- Profundidad instalación 37 mm

Marcos berker B.7



1011 69 19

Marcos blanco polar, mate

Descripción	Referencia	Emb.	Precio (€)
1 elemento	1011 69 19	10	3,82
2 elementos	1012 69 19	10	5,57
3 elementos	1013 69 19	10	9,59
4 elementos	1014 69 19	1	34,00
5 elementos	1015 69 19	1	54,00



1011 66 26

Marcos antracita, mate

Descripción	Referencia	Emb.	Precio (€)
1 elemento	1011 66 26	10	5,55
2 elementos	1012 66 26	10	8,49
3 elementos	1013 66 26	5	13,94
4 elementos	1014 66 26	1	40,00
5 elementos	1015 66 26	1	56,00



1011 64 24

Marcos aluminio, mate

Descripción	Referencia	Emb.	Precio (€)
1 elemento	1011 64 24	10	4,72
2 elementos	1012 64 24	10	7,41
3 elementos	1013 64 24	5	38,98
4 elementos	1014 64 24	1	43,58
5 elementos	1015 64 24	1	68,34



1011 69 14

Marcos aluminio/blanco polar, mate

Descripción	Referencia	Emb.	Precio (€)
1 elemento	1011 69 14	10	40,00
2 elementos	1012 69 14	5	70,62
3 elementos	1013 69 14	5	80,89
4 elementos	1014 69 14	1	110,63
5 elementos	1015 69 14	1	150,78



1011 69 04

Marcos aluminio/antracita, mate

Descripción	Referencia	Emb.	Precio (€)
1 elemento	1011 69 04	10	40,00
2 elementos	1012 69 04	5	70,62
3 elementos	1013 69 04	5	78,42
4 elementos	1014 69 04	1	107,25
5 elementos	1015 69 04	1	146,17



1309 69 09

Marco para teclados KNX

Descripción	Referencia	Emb.	Precio (€)
Blanco polar, mate	1309 69 19	2	28,92
Aluminio, mate	1309 64 24	2	28,92
Antracita	1309 66 26	2	28,92
Aluminio/blanco polar, mate	1309 69 14	2	169,19
Aluminio/antracita, mate	1309 69 04	2	169,19
Acero inoxidable/antracita, mate	1309 36 09	2	121,01
Acero inoxidable/blanco polar, mate	1309 36 06	2	121,01
Cristal, blanco polar	1309 69 09	2	46,18
Cristal, antracita	1309 66 16	2	46,18
Cristal, aluminio	1309 64 14	2	46,18

- No es válido para montajes en superficie
- Montaje vertical



1011 36 09

Marcos acero inoxidable/blanco polar, mate

Descripción	Referencia	Emb.	Precio (€)
1 elemento	1011 36 09	10	45,00
2 elementos, vertical	1012 36 09	5	79,45
3 elementos, vertical	1013 36 09	5	132,85
4 elementos, vertical	1014 36 09	1	181,71
5 elementos, vertical	1015 36 09	1	190,00
2 elementos, horizontal	1022 36 09	5	79,45
3 elementos, horizontal	1023 36 09	5	132,85
4 elementos, horizontal	1024 36 09	1	181,71
5 elementos, horizontal	1025 36 09	1	190,00

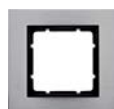

1011 36 06

Marcos acero inoxidable/antracita, mate

Descripción	Referencia	Emb.	Precio (€)
1 elemento	1011 36 06	10	45,00
2 elementos, vertical	1012 36 06	5	79,45
3 elementos, vertical	1013 36 06	5	132,85
4 elementos, vertical	1014 36 06	1	181,71
5 elementos, vertical	1015 36 06	1	190,00
2 elementos, horizontal	1022 36 06	5	79,45
3 elementos, horizontal	1023 36 06	5	132,85
4 elementos, horizontal	1024 36 06	1	181,71
5 elementos, horizontal	1025 36 06	1	190,00



1011 69 09

Marcos cristal blanco polar

Descripción	Referencia	Emb.	Precio (€)
1 elemento	1011 69 09	10	23,77
2 elementos	1012 69 09	5	44,37
3 elementos	1013 69 09	5	71,99
4 elementos	1014 69 09	1	97,92
5 elementos	1015 69 09	1	129,25

- Montaje vertical y horizontal
- No válido para montaje en superficie

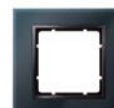

1011 66 16

Marcos cristal antracita

Descripción	Referencia	Emb.	Precio (€)
1 elemento	1011 66 16	10	23,77
2 elementos	1012 66 16	5	44,37
3 elementos	1013 66 16	5	71,99
4 elementos	1014 66 16	1	97,92
5 elementos	1015 66 16	1	129,25

- Montaje vertical y horizontal



1011 64 14

Marcos cristal aluminio

Descripción	Referencia	Emb.	Precio (€)
1 elemento	1011 64 14	10	23,77
2 elementos	1012 64 14	5	44,37
3 elementos	1013 64 14	5	71,99
4 elementos	1014 64 14	1	97,92
5 elementos	1015 64 14	1	129,25

- Montaje vertical y horizontal
- Para resaltar interruptores especiales, tomas de corriente, ...

Tomas de corriente



1719 89 89

Tapa para SCHUKO

Descripción	Referencia	Emb.	Precio (€)
Blanco, brillo	1719 89 82	10	3,82
Blanco polar, brillo	1719 89 89	10	3,82
Blanco polar, mate	1719 19 09	10	4,12
Antracita	1719 16 06	10	4,40
Aluminio	1719 14 04	10	5,55
Rojo, mate	1719 19 12	10	4,20
Rojo, brillo	1719 89 12	10	3,90

- Añadir mecanismo ref: 714134
- Con protección infantil



4149 89 89

Toma SCHUKO con portaetiquetas

Descripción	Referencia	Emb.	Precio (€)
Blanco, brillo	4149 89 82	10	10,40
Blanco polar, brillo	4149 89 89	10	10,40
Blanco polar, mate	4149 19 09	10	11,22
Antracita	4149 16 06	10	12,44
Aluminio	4149 14 04	10	15,91

- 16A, 250 V~
- Con protección infantil
- Etiquetas de 6 mm alto
- Conexión por tornillo



4109 89 82

Toma SCHUKO con LED de orientación

Descripción	Referencia	Emb.	Precio (€)
Blanco, brillo	4109 89 82	10	74,37
Blanco polar, brillo	4109 89 89	10	74,29
Blanco polar, mate	4109 19 09	10	74,29
Antracita	4109 16 06	10	74,37
Aluminio	4109 14 04	10	76,12

- 16A, 250 V~
- Con protección infantil
- Conexión por tornillo



4110 89 82

Toma SCHUKO con LED de control

Descripción	Referencia	Emb.	Precio (€)
Blanco, brillo	4110 89 82	10	20,93
Blanco polar, brillo	4110 89 89	10	20,93
Blanco polar, mate	4110 19 09	10	20,93

- 16A, 250 V~
- Con protección infantil
- Etiquetas de 6 mm alto
- Conexión por tornillo



4142 89 82

Toma SCHUKO S.1 monobloc

Descripción	Referencia	Emb.	Precio (€)
Blanco, brillo	4142 89 82	10	5,80
Blanco polar, brillo	4142 89 89	10	5,80
Blanco polar, mate	4142 99 09	10	5,80

- Toma SCHUKO completa (marco incluido)

NUEVO

Toma afeitar berker S.1

Descripción	Referencia	Emb.	Precio (€)
Blanco polar	33 4475 89 09	10	89,00
Antracita	33 4475 86 06	10	90,78

Teclas



1620 19 09

Tecla

Descripción	Referencia	Emb.	Precio (€)
Blanco, brillo	1620 89 82	10	1,33
Blanco polar, brillo	1620 89 89	10	1,33
Blanco polar, mate	1620 19 09	10	1,43
Antracita	1620 16 06	10	2,70
Aluminio	1620 14 04	10	5,80



1626 19 09

Tecla con portaetiquetas

Descripción	Referencia	Emb.	Precio (€)
Blanco, brillo	1626 89 82	10	5,81
Blanco polar, brillo	1626 89 89	10	5,81
Blanco polar, mate	1626 19 09	10	6,63
Antracita	1626 16 06	10	7,20
Aluminio	1626 14 04	10	10,00

- Etiquetas de 6 mm alto



1621 19 09

Tecla con 5 indicadores luminosos

Descripción	Referencia	Emb.	Precio (€)
Blanco, brillo	1621 89 82	10	2,65
Blanco polar, brillo	1621 89 89	10	3,95
Blanco polar, mate	1621 19 09	10	2,65
Antracita	1621 16 06	10	5,50
Aluminio	1621 14 04	10	8,20

- Indicadores: luz, campana, puerta, neutro transparente, neutro rojo



1628 19 09

Tecla con 5 indicadores luminosos y portaetiquetas

Descripción	Referencia	Emb.	Precio (€)
Blanco, brillo	1628 89 82	10	6,83
Blanco polar, brillo	1628 89 89	10	6,83
Blanco polar, mate	1628 19 09	10	7,65
Antracita	1628 16 06	10	8,20
Aluminio	1628 14 04	10	10,90

- Etiquetas de 6 mm alto



1696 19 09

Tecla 5 indicadores luminosos y portaetiq. grande

Descripción	Referencia	Emb.	Precio (€)
Blanco, brillo	1696 89 82	10	8,89
Blanco polar, brillo	1696 89 89	10	8,86
Blanco polar, mate	1696 19 09	10	8,48
Antracita	1696 16 06	10	9,31
Aluminio	1696 14 04	10	12,34

- Portaetiquetas 50,8 x 25,5 mm
- Etiquetas de 12 mm alto



1622 19 09

Tecla con "0"

Descripción	Referencia	Emb.	Precio (€)
Blanco, brillo	1622 89 82	10	4,18
Blanco polar, brillo	1622 89 89	10	4,18
Blanco polar, mate	1622 19 09	10	3,57
Antracita	1622 16 06	10	5,00
Aluminio	1622 14 04	10	6,70



1624 19 09

Tecla con "0" e indicador luminoso

Descripción	Referencia	Emb.	Precio (€)
Blanco, brillo	1624 89 82	10	5,20
Blanco polar, brillo	1624 89 89	10	5,20
Blanco polar, mate	1624 19 09	10	7,14
Antracita	1624 16 06	10	5,80
Aluminio	1624 14 04	10	8,30

Interruptor rotativo

Descripción	Referencia	Emb.	Precio (€)
Blanco, brillo	1150 89 82	1	10,61
Blanco polar, brillo	1150 89 89	1	10,61
Blanco polar, mate	1150 19 09	1	11,02
Antracita	1150 16 06	1	15,60
Aluminio	1150 14 04	1	16,10

**Tecla doble**

Descripción	Referencia	Emb.	Precio (€)
Blanco, brillo	1623 89 82	10	2,45
Blanco polar, brillo	1623 89 89	10	2,45
Blanco polar, mate	1623 19 09	10	2,55
Antracita	1623 16 06	10	5,30
Aluminio	1623 14 04	10	8,10

1623 19 09

**Tecla doble con indicador luminoso**

Descripción	Referencia	Emb.	Precio (€)
Blanco, brillo	1627 89 82	10	7,65
Blanco polar, brillo	1627 89 89	10	7,65
Blanco polar, mate	1627 19 09	10	8,47
Antracita	1627 16 06	10	7,00
Aluminio	1627 14 04	10	9,90

1627 19 09

**Tecla para mecanismo triple ON/OFF**

Descripción	Referencia	Emb.	Precio (€)
Blanco, brillo	1665 89 82	10	8,36
Blanco polar, brillo	1665 89 89	10	8,36
Blanco polar, mate	1665 19 09	10	9,49
Antracita	1665 16 06	10	11,80
Aluminio	1665 14 04	10	13,90

1665 89 82

• Teclado triple ref. 6330 23

**Tecla doble persiana**

Descripción	Referencia	Emb.	Precio (€)
Blanco, brillo	1625 89 82	10	5,30
Blanco polar, brillo	1625 89 89	10	5,30
Blanco polar, mate	1625 19 09	10	5,92
Antracita	1625 16 06	10	9,20
Aluminio	1625 14 04	10	11,80

1625 19 09

**Tecla simple con tornillos, "0" e indicador luminoso**

Descripción	Referencia	Emb.	Precio (€)
Blanco polar, mate	1577 19 09	10	23,07
Antracita	1577 16 06	10	23,66
Aluminio	1577 14 04	10	24,59

1577 19 09

**Tecla doble con tornillos**

Descripción	Referencia	Emb.	Precio (€)
Blanco polar, mate	1571 19 09	10	14,88
Antracita	1571 16 06	10	14,73
Aluminio	1571 14 04	10	13,74

1571 19 09

Teclas sin barreras**Tecla simple con 5 lentes**

Descripción	Referencia	Emb.	Precio (€)
Blanco polar, mate	1661 19 49	10	10,10

1661 19 49

**Tecla simple con lente rojo y símbolo luz en relieve**

Descripción	Referencia	Emb.	Precio (€)
Blanco polar, mate	1651 19 49	10	8,98

1651 19 49

**Tecla simple c/lente rojo y símbolo campana en relieve**

Descripción	Referencia	Emb.	Precio (€)
Blanco polar, mate	1651 19 59	10	8,98

1651 19 59

**Tecla simple c/ lente rojo y símbolo llave en relieve**

Descripción	Referencia	Emb.	Precio (€)
Blanco polar, mate	1651 19 69	10	8,98

1651 19 69

• Sin barreras basado en DIN 18025

Teclas con tornillos**Tecla simple con tornillos**

Descripción	Referencia	Emb.	Precio (€)
Blanco polar, mate	1570 19 09	10	19,70
Antracita	1570 16 06	10	22,15
Aluminio	1570 14 04	10	23,49

1570 19 09

**Tecla simple con tornillos e indicador luminoso**

Descripción	Referencia	Emb.	Precio (€)
Blanco polar, mate	1572 19 09	10	23,78
Antracita	1572 16 06	10	23,97
Aluminio	1572 14 04	10	25,42

1572 19 09

**Tecla simple con tornillos y "0"**

Descripción	Referencia	Emb.	Precio (€)
Blanco polar, mate	1573 19 09	10	21,32
Antracita	1573 16 06	10	21,91
Aluminio	1573 14 04	10	23,11

1573 19 09

Tapas**Tapa tarjetero de hotel con indicador luminoso**

Descripción	Referencia	Emb.	Precio (€)
Blanco, brillo	1640 89 82	10	8,87
Blanco polar, brillo	1640 89 89	10	8,87
Blanco polar, mate	1640 19 09	10	9,89
Antracita	1640 16 06	10	30,00
Aluminio	1640 14 04	10	55,00

1640 19 09

• Mecanismo ref.: 5051 02, 5051 03, 5052 01, 5056 01

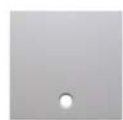
**Tapa interruptor / pulsador tirador**

Descripción	Referencia	Emb.	Precio (€)
Blanco, brillo	1146 89 82	10	5,00
Blanco polar, brillo	1146 89 89	10	5,00
Blanco polar, mate	1146 19 09	10	7,24
Antracita	1146 16 06	10	8,26
Aluminio	1146 14 04	10	11,53

1146 19 09

**Tapa para interruptor 3 posiciones c/mando rotativo**

Descripción	Referencia	Emb.	Precio (€)
Sin posición 0			
Blanco, brillo	1084 89 82	1	8,17
Blanco polar, brillo	1084 89 89	1	8,58
Blanco polar, mate	1084 19 09	1	9,49
Antracita	1084 16 06	1	11,12
Aluminio	1084 14 04	1	15,91
Con posición neutra			
Blanco, brillo	1096 89 82	1	8,26
Blanco polar, brillo	1096 89 89	1	8,26
Blanco polar, mate	1096 19 09	1	9,49
Antracita	1096 16 06	1	11,12
Aluminio	1096 14 04	1	15,91

1084 19 09



1080 19 09

Tapa para interruptor/pulsador rotativo persianas

Descripción	Referencia	Emb.	Precio (€)
Blanco, brillo	1080 89 82	1	8,17
Blanco polar, brillo	1080 89 89	1	8,40
Blanco polar, mate	1080 19 09	1	10,10
Antracita	1080 16 06	1	11,12
Aluminio	1080 14 04	1	15,91



1081 19 09

Tapa c/cerradura para interruptor de llave persianas

Descripción	Referencia	Emb.	Precio (€)
Llave extraíble en posición media			
Blanco, brillo	1081 89 82	1	46,72
Blanco polar, brillo	1081 89 89	1	46,72
Blanco polar, mate	1081 19 09	1	72,22
Antracita	1081 16 06	1	73,85
Aluminio	1081 14 04	1	73,75



1082 89 82

Descripción	Referencia	Emb.	Precio (€)
Llave extraíble en las 3 posiciones			
Blanco, brillo	1082 89 82	1	46,82
Blanco polar, brillo	1082 89 89	1	46,82
Blanco polar, mate	1082 19 09	1	72,22

• Función bloqueo presión



1083 19 09

Tapa c/cerradura para interruptor de llave persianas

Descripción	Referencia	Emb.	Precio (€)
Blanco, brillo	1083 89 82	1	46,82
Blanco polar, brillo	1083 89 89	1	46,82
Blanco polar, mate	1083 19 09	1	72,22

• Función sólo pulsador
• Llave extraíble en posición media



1506 19 09

Tapa para interruptor/pulsador de llave de persianas

Descripción	Referencia	Emb.	Precio (€)
Blanco, brillo	1506 89 82	10	10,40
Blanco polar, brillo	1506 89 89	10	10,40
Blanco polar, mate	1506 19 09	10	17,03
Antracita	1506 16 06	10	18,97
Aluminio	1506 14 04	10	26,21

• Con símbolo persiana



1507 19 09

Blanco, brillo	1507 89 82	10	10,40
Blanco polar, brillo	1507 89 89	10	10,40
Blanco polar, mate	1507 19 09	10	17,03
Antracita	1507 16 06	10	18,97
Aluminio	1507 14 04	10	26,21

• Sin símbolo

Señalización



5101 99 09

Piloto / pulsador escalera E10 monobloc

Descripción	Referencia	Emb.	Precio (€)
Blanco, brillo	5101 89 82	10	25,50
Blanco polar, brillo	5101 89 89	10	25,50
Blanco polar, mate	5101 99 09	10	25,50

• Marco incluido

Tapa interruptor protección diferencial



1493 19 09

Tapa central 50x50 mm para interruptor protección dif.

Descripción	Referencia	Emb.	Precio (€)
Blanco, brillo	1493 02	1	6,78
Blanco polar, brillo	1493 09	1	6,78
Blanco polar, mate	1493 19 09	1	6,78
Antracita	1493 16 06	1	10,44
Aluminio	1493 14 04	1	15,91
Marrón	1493 01	1	11,96
Acero	1493 04	1	15,91
Bronce	1493 11	1	18,18

• Utilizar sólo con marcos intermedios para tapas centrales
50 x 50 mm de cada serie

Tapas ciegas



1009 19 09

Tapa ciega con tapa central

Descripción	Referencia	Emb.	Precio (€)
Sin garras			
Blanco, brillo	1009 89 82	20	8,26
Blanco polar, brillo	1009 89 89	20	8,26
Blanco polar, mate	1009 19 09	20	8,57
Antracita	1009 16 06	20	11,10
Aluminio	1009 14 04	20	14,20

Con base y garras

Blanco, brillo	67 1009 89 82	10	8,47
Blanco polar, brillo	67 1009 89 89	10	8,47
Blanco polar, mate	67 1009 19 09	10	8,57
Antracita	67 1009 16 06	10	11,10
Aluminio	67 1009 14 04	10	14,20



1009 19 19

Tapa ciega atornillada

Descripción	Referencia	Emb.	Precio (€)
Blanco, brillo	1009 89 12	20	10,40
Blanco polar, brillo	1009 89 19	20	10,40
Blanco polar, mate	1009 19 19	20	11,53
Antracita	1009 16 16	20	14,48
Aluminio	1009 14 14	20	17,54

• Sin garras

Señalización



1124 19 09

Tapa central para piloto / pulsador y lámpara E10

Descripción	Referencia	Emb.	Precio (€)
Blanco, brillo	1124 89 82	10	2,24
Blanco polar, brillo	1124 89 89	10	2,24
Blanco polar, mate	1124 19 09	10	5,81
Antracita	1124 16 06	10	7,04
Aluminio	1124 14 04	10	10,10



1198 19 09

Tapa central para piloto lámpara E14

Descripción	Referencia	Emb.	Precio (€)
Blanco, brillo	1198 89 82	10	3,77
Blanco polar, brillo	1198 89 89	10	3,77
Blanco polar, mate	1198 19 09	10	6,02
Antracita	1198 16 06	10	6,83
Aluminio	1198 14 04	10	10,10

Temporizadores



1632 19 09

Tapa c/mando rotativo para temporizador mecánico

Descripción	Referencia	Emb.	Precio (€)
Máximo 15 minutos			
Blanco, brillo	1632 89 82	1	8,87
Blanco polar, brillo	1632 89 89	1	8,87
Blanco polar, mate	1632 19 09	1	15,40
Antracita	1632 16 06	1	17,65
Aluminio	1632 14 04	1	24,68

Máximo 120 minutos

Blanco, brillo	1633 89 82	1	8,87
Blanco polar, brillo	1633 89 89	1	8,87
Blanco polar, mate	1633 19 09	1	15,40
Antracita	1633 16 06	1	17,65
Aluminio	1633 14 04	1	24,68



1674 19 09

Tapa con pulsador para relé temporizador

Descripción	Referencia	Emb.	Precio (€)
Blanco, brillo	1674 89 82	10	10,65
Blanco polar, brillo	1674 89 89	10	10,65
Blanco polar, mate	1674 19 09	10	10,65
Antracita	1674 16 06	10	15,79
Aluminio	1674 14 04	10	23,24



1735 19 09

Temporizador sencillo con pantalla

Descripción	Referencia	Emb.	Precio (€)
Blanco, brillo	1735 89 82	1	149,50
Blanco polar, brillo	1735 89 89	1	149,50
Blanco polar, mate	1735 19 09	1	149,50
Antracita	1735 16 06	1	153,29
Aluminio	1735 14 04	1	159,17



1736 19 09

Temporizador con pantalla

Descripción	Referencia	Emb.	Precio (€)
Blanco, brillo	1736 89 82	1	228,71
Blanco polar, brillo	1736 89 89	1	228,71
Blanco polar, mate	1736 19 09	1	228,71
Antracita	1736 16 06	1	232,46
Aluminio	1736 14 04	1	238,34

- Con impresión en alemán



1738 19 09

Temporizador con pantalla y conexión de sensor

Descripción	Referencia	Emb.	Precio (€)
Blanco, brillo	1738 89 82	1	275,60
Blanco polar, brillo	1738 89 89	1	275,60
Blanco polar, mate	1738 19 09	1	275,60
Antracita	1738 16 06	1	279,39
Aluminio	1738 14 04	1	285,23

- Con impresión en alemán

Tapa regulador rotativo



1137 19 09

Tapa central c/mando rotativo para regulad. rotativo

Descripción	Referencia	Emb.	Precio (€)
Blanco, brillo	1137 89 82	10	5,84
Blanco polar, brillo	1137 89 89	10	5,84
Blanco polar, mate	1137 19 09	10	8,88
Antracita	1137 16 06	10	14,03
Aluminio	1137 14 04	10	21,55

Tapa control velocidad



1137 19 29

Tapa central con mando para control velocidad

Descripción	Referencia	Emb.	Precio (€)
Blanco, brillo	1137 89 22	10	10,65
Blanco polar, brillo	1137 89 29	10	10,65
Blanco polar, mate	1137 19 29	10	10,65
Antracita	1137 16 26	10	15,79
Aluminio	1137 14 24	10	23,24

Tapa regulador universal



1765 19 09

Pulsador para regulador universal

Descripción	Referencia	Emb.	Precio (€)
Blanco, brillo	1765 89 82	1	34,67
Blanco polar, brillo	1765 89 89	1	34,67
Blanco polar, mate	1765 19 09	1	34,67
Antracita	1765 16 06	1	36,89
Aluminio	1765 14 04	1	41,87

Termostatos



2030 19 09

Termostato

Descripción	Referencia	Emb.	Precio (€)
Blanco, brillo	2030 89 82	1	82,62
Blanco polar, brillo	2030 89 89	1	82,62
Blanco polar, mate	2030 19 09	1	93,84
Antracita	2030 16 06	1	99,96
Aluminio	2030 14 04	1	104,04

- 250V, 10 (4)A CA



2026 19 09

Termostato con conmutador

Descripción	Referencia	Emb.	Precio (€)
Blanco, brillo	2026 89 82	1	82,62
Blanco polar, brillo	2026 89 89	1	82,62
Blanco polar, mate	2026 19 09	1	93,84
Antracita	2026 16 06	1	99,96
Aluminio	2026 14 04	1	104,04

- 230 V
- calefacción: 10 (4) A
- refrigeración: 5 (2) A



2034 19 09

Termostato de suelo radiante

Descripción	Referencia	Emb.	Precio (€)
Blanco, brillo	2034 89 82	1	284,00
Blanco polar, brillo	2034 89 89	1	284,00
Blanco polar, mate	2034 19 09	1	284,00
Antracita	2034 16 06	1	289,96
Aluminio	2034 14 04	1	293,86



7594 04 09

Tapa sensor

Descripción	Referencia	Emb.	Precio (€)
Blanco, brillo	7594 04 02	1	3,59
Blanco polar, brillo	7594 04 09	1	3,59
Blanco polar, mate	7594 04 89	1	3,59
Antracita	7594 04 85	1	9,22
Aluminio	7594 04 83	1	11,10
Acero	7594 04 03	1	13,90
Bronce	7594 04 04	1	13,90

- Utilizar sólo con marcos intermedios de la serie correspondiente
- Mecanismo ref: 7594 10 01
- Familia 96

Tarjetero hotel electrónico



1640 89 99

Tarjetero hotel electrónico

Descripción	Referencia	Emb.	Precio (€)
Blanco, brillo	1640 89 92	1	72,50
Blanco polar, brillo	1640 89 99	1	72,50
Blanco polar, mate	1640 99 09	1	72,50
Antracita	1640 99 06	1	73,00
Aluminio	1640 89 84	1	73,97

Entretenimiento



2880 89 89

Radio

Descripción	Referencia	Emb.	Precio (€)
Blanco polar, brillo	2880 89 89	1	299,60
Blanco polar, mate	2880 99 09	1	299,98
Acero	2880 89 16	1	307,99

- Incluye un altavoz

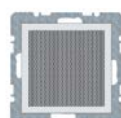

2882 89 89

Altavoz

Descripción	Referencia	Emb.	Precio (€)
Blanco polar, brillo	2882 89 89	1	58,27
Blanco polar, mate	2882 99 09	1	58,60
Acero	2882 89 16	1	61,86

TV / Audio / Video



33 1532 19 09

Toma 3 x Cinch/S-Video

Descripción	Referencia	Emb.	Precio (€)
Blanco, brillo	33 1532 89 82	10	127,99
Blanco polar, brillo	33 1532 89 89	10	127,99
Blanco polar, mate	33 1532 19 09	10	127,99
Antracita	33 1532 16 06	10	139,88
Aluminio	33 1532 14 04	10	143,79



33 1540 89 89

Toma VGA

Descripción	Referencia	Emb.	Precio (€)
Blanco, brillo	33 1540 89 82	10	64,08
Blanco polar, brillo	33 1540 89 89	10	64,08
Blanco polar, mate	33 1540 19 09	10	64,08
Antracita	33 1540 16 06	10	71,48
Aluminio	33 1540 14 04	10	75,39



33 1541 89 89

Toma VGA con terminales a tornillo y mordaza

Descripción	Referencia	Emb.	Precio (€)
Blanco, brillo	33 1541 89 82	10	64,08
Blanco polar, brillo	33 1541 89 89	10	64,08
Blanco polar, mate	33 1541 19 09	10	64,08
Antracita	33 1541 16 06	10	71,48
Aluminio	33 1541 14 04	10	75,39



33 1539 19 09

Toma USB / audio 3,5 mm.

Descripción	Referencia	Emb.	Precio (€)
Blanco, brillo	33 1539 89 82	10	84,15
Blanco polar, brillo	33 1539 89 89	10	84,15
Blanco polar, mate	33 1539 19 09	10	84,15
Antracita	33 1539 16 06	10	92,95
Aluminio	33 1539 14 04	10	96,90



33 1542 89 89

Toma alta definición

Descripción	Referencia	Emb.	Precio (€)
Blanco, brillo	33 1542 89 82	1	146,30
Blanco polar, brillo	33 1542 89 89	1	146,30
Blanco polar, mate	33 1542 19 09	10	146,30
Antracita	33 1542 16 06	10	159,42
Aluminio	33 1542 14 04	10	163,32



33 1543 89 89

Toma alta definición con conexión 90°

Descripción	Referencia	Emb.	Precio (€)
Blanco, brillo	33 1543 89 82	10	146,30
Blanco polar, brillo	33 1543 89 89	10	146,30
Blanco polar, mate	33 1543 19 09	10	146,30
Antracita	33 1543 16 06	10	159,42
Aluminio	33 1543 14 04	10	163,32



1412 19 09

Tapa central para conectores redondos XLR serie D

Descripción	Referencia	Emb.	Precio (€)
Blanco, brillo	1412 02	10	7,96
Blanco polar, brillo	1412 09	10	7,96
Blanco polar, mate	1412 19 09	10	8,87
Antracita	1412 16 06	10	11,12
Aluminio	1412 14 04	10	16,32



1196 19 09

Tapa central para toma altavoz y conector mini

Descripción	Referencia	Emb.	Precio (€)
Blanco, brillo	1196 89 82	10	4,69
Blanco polar, brillo	1196 89 89	10	4,69
Blanco polar, mate	1196 19 09	10	6,22
Antracita	1196 16 06	10	7,45
Aluminio	1196 14 04	10	10,51



1499 89 82

Tapa central para toma TV 1 salida

Descripción	Referencia	Emb.	Precio (€)
Blanco, brillo	1499 89 82	10	4,59
Blanco polar, brillo	1499 89 89	10	4,59
Blanco polar, mate	1499 19 09	10	5,20
Antracita	1499 16 06	10	6,43
Aluminio	1499 14 04	10	8,80



1203 19 09

Tapa central para toma TV 2 ó 3 salidas

Descripción	Referencia	Emb.	Precio (€)
Blanco, brillo	1203 89 82	10	1,94
Blanco polar, brillo	1203 89 89	10	1,94
Blanco polar, mate	1203 19 09	10	1,94
Antracita	1203 16 06	10	7,70
Aluminio	1203 14 04	10	10,90



1484 09

Tapa central para toma TV 4 salidas

Descripción	Referencia	Emb.	Precio (€)
Blanco, brillo	1484 02	10	4,08
Blanco polar, brillo	1484 09	10	4,08
Blanco polar, mate	1484 19 09	10	3,98
Antracita	1484 16 06	10	6,63
Aluminio	1484 14 04	10	10,00
Marrón	1484 01	10	8,77
Acero	1484 04	10	10,61
Bronce	1484 11	10	10,61

- Utilizar sólo con marcos intermedios de la serie correspondiente
- Tomas TV de Ankaró, Astro, Axing, Delta, Schwaiger



1483 09

Tapa central para toma TV 4 salidas con tornillo

Descripción	Referencia	Emb.	Precio (€)
Blanco, brillo	1483 02	10	3,77
Blanco polar, brillo	1483 09	10	3,77
Blanco polar, mate	1483 19 09	10	4,08
Antracita	1483 16 06	10	6,63
Aluminio	1483 14 04	10	10,00
Marrón	1483 01	10	8,87
Acero	1483 04	10	13,16
Bronce	1483 11	10	10,61

- Utilizar sólo con marcos intermedios de la serie correspondiente
- Tomas TV de Hirschmann

Marcos intermedios



1109 19 19

Anillo adaptador para tapa 50 x 50 mm

Descripción	Referencia	Emb.	Precio (€)
Blanco, brillo	1109 90 82	10	1,84
Blanco polar, brillo	1109 90 89	10	1,84
Blanco polar, mate	1109 19 19	10	2,79
Antracita	1109 16 16	10	2,14
Aluminio	1109 14 14	10	2,82



1109 19 09

Marco intermedio para tapas centrales

Descripción	Referencia	Emb.	Precio (€)
Blanco, brillo	1109 89 82	10	2,30
Blanco polar, brillo	1109 89 89	10	2,00
Blanco polar, mate	1109 19 09	10	1,73
Antracita	1109 16 06	10	2,79
Aluminio	1109 14 04	10	3,37

Portaetiquetas para marco intermedio

1905 00 69	Descripción	Referencia	Emb.	Precio (€)
	Blanco, brillo	1905 00 02	10	3,67
	Blanco polar, brillo	1905 00 69	10	3,67
	Acero	1905 70 04	10	6,07

Tapa salida de cables

Tapa central para salida de cable

1019 19 09	Descripción	Referencia	Emb.	Precio (€)
	Blanco, brillo	1019 89 82	10	3,77
	Blanco polar, brillo	1019 89 89	10	3,77
	Blanco polar, mate	1019 19 09	10	4,65
	Antracita	1019 16 06	10	7,14
	Aluminio	1019 14 04	10	10,00

Tapas altavoz / datos / telecomunicaciones

Tapa central para toma TAE y altavoz

1033 89 19	Descripción	Referencia	Emb.	Precio (€)
	Blanco, brillo	1033 89 12	10	4,69
	Blanco polar, brillo	1033 89 19	10	4,69
	Blanco polar, mate	1033 19 09	10	5,30
	Antracita	1033 16 06	10	7,45
	Aluminio	1033 14 04	10	10,10

Tapa central para toma TAE 6/6FFy 6/6NF y altavoz

1458 09	Descripción	Referencia	Emb.	Precio (€)
	Blanco, brillo	1458 02	10	3,77
	Blanco polar, brillo	1458 09	10	3,77
	Marrón	1458 01	10	8,77

Tapa central para toma teléfono / red

1407 19 09	Descripción	Referencia	Emb.	Precio (€)
	Blanco, brillo	1407 89 82	10	3,77
	Blanco polar, brillo	1407 89 89	10	3,77
	Blanco polar, mate	1407 19 09	10	3,77
	Antracita	1407 16 06	10	5,80
	Aluminio	1407 14 04	10	8,20

Tapa central para toma teléfono / red doble

1409 19 09	Descripción	Referencia	Emb.	Precio (€)
	Blanco, brillo	1409 89 82	10	4,59
	Blanco polar, brillo	1409 89 89	10	4,59
	Blanco polar, mate	1409 19 09	10	5,63
	Antracita	1409 16 06	10	7,00
	Aluminio	1409 14 04	10	9,90

Tapa central protección suciedad y portaetiquetas

1170 19 09	Descripción	Referencia	Emb.	Precio (€)
	Blanco polar, mate	1170 19 09	10	8,98
	Antracita	1170 16 06	10	13,16
	Aluminio	1170 14 04	10	17,65

Tapa central protección suciedad y portaeti. doble

1181 19 09	Descripción	Referencia	Emb.	Precio (€)
	Blanco, brillo	1181 89 82	10	8,87
	Blanco polar, brillo	1181 89 89	10	8,87
	Blanco polar, mate	1181 19 09	10	12,24
	Antracita	1181 16 06	10	16,73
	Aluminio	1181 14 04	10	18,16

Tapa central para AMP-ACO

1494 09	Descripción	Referencia	Emb.	Precio (€)
	Blanco, brillo	1494 02	10	4,18
	Blanco polar, brillo	1494 09	10	4,18
	Blanco polar, mate	1494 19 09	10	4,59
	Antracita	1494 16 06	10	6,63
	Aluminio	1494 14 04	10	10,00

- Utilizar sólo con marcos intermedios de la serie correspondiente
- Portaetiquetas no disponible

Tapa central para AMP-ACO con portaetiquetas

1495 09	Descripción	Referencia	Emb.	Precio (€)
	Blanco, brillo	1495 02	10	6,43
	Blanco polar, brillo	1495 09	10	6,43
	Blanco polar, mate	1495 19 09	10	7,69
	Antracita	1495 16 06	10	8,87
	Aluminio	1495 14 04	10	11,93

- Utilizar sólo con marcos intermedios de la serie correspondiente

Tapa central acopladores de fibra óptica Simplex ST

1492 09	Descripción	Referencia	Emb.	Precio (€)
	Blanco, brillo	1492 02	10	16,22
	Blanco polar, brillo	1492 09	10	16,22
	Blanco polar, mate	1492 19 09	10	19,04

- Utilizar sólo con marcos intermedios de la serie correspondiente

Tapa central acopladores fibra óptica Duplex SCT

1480 09	Descripción	Referencia	Emb.	Precio (€)
	Blanco, brillo	1480 02	10	16,73
	Blanco polar, brillo	1480 09	10	16,73
	Blanco polar, mate	1480 19 09	10	19,04

- Utilizar sólo con marcos intermedios de la serie correspondiente

Tapa central para conector 1 D-subminiatura

1411 19 09	Descripción	Referencia	Emb.	Precio (€)
	Blanco, brillo	1411 02	10	7,55
	Blanco polar, brillo	1411 09	10	7,55
	Blanco polar, mate	1411 19 09	10	7,65

- Utilizar sólo con marcos intermedios de la serie correspondiente

Tapa central para conector 2 D-subminiatura

1470 19 09	Descripción	Referencia	Emb.	Precio (€)
	Blanco, brillo	1470 02	10	15,07
	Blanco polar, brillo	1470 09	10	15,07
	Blanco polar, mate	1470 19 09	10	16,28

- Utilizar sólo con marcos intermedios de la serie correspondiente

Tapa toma USB de carga

Tapa toma USB de carga

68 1033 89 82	Descripción	Referencia	Emb.	Precio (€)
	Blanco, brillo	68 1033 89 82	10	3,60
	Blanco polar, brillo	68 1033 89 89	10	3,60
	Blanco polar, mate	68 1033 19 09	10	3,80
	Antracita	68 1033 16 06	10	5,60
	Aluminio	68 1033 14 04	10	5,60

Unidades de señalización y gestión



1431 09

Tapa transmisión y control de dispositivo 18'8 mm

Descripción	Referencia	Emb.	Precio (€)
Blanco, brillo	1431 02	10	7,85
Blanco polar, brillo	1431 09	10	7,85
Blanco polar, mate	1431 19 09	10	9,33
Antracita	1431 16 06	10	11,83
Aluminio	1431 14 04	10	14,89
Acero	1431 04	10	16,42

- Utilizar sólo con marcos intermedios de la serie correspondiente
- Mecanismo ref: 4604

Tapas sistemas hospitalarios



1403 19 09

Tapa toma doble equipotencial

Descripción	Referencia	Emb.	Precio (€)
Blanco, brillo	1403 02	10	7,85
Blanco polar, brillo	1403 09	10	7,85
Blanco polar, mate	1403 19 09	10	7,75
Antracita	1403 16 06	10	10,20
Aluminio	1403 14 04	10	14,69

- Mecanismo ref: 1061



1474 09

Tapa para toma 6 polos / Timbre BBH01

Descripción	Referencia	Emb.	Precio (€)
Blanco, brillo	1474 02	10	6,63
Blanco polar, brillo	1474 09	10	6,63
Blanco polar, mate	1474 19 09	10	7,24
Antracita	1474 16 06	10	8,57
Aluminio	1474 14 04	10	11,53
Acero	1474 04	10	20,60

- Utilizar sólo con marcos intermedios correspondientes para BBH01:

- 1109 89 82 - Blanco
- 1109 89 89 - Blanco polar brillo
- 1109 19 09 - Blanco polar mate
- 1109 14 04 - Aluminio
- 1109 16 06 - Antracita

Detector de movimiento



2995

Detector de movimiento

Descripción	Referencia	Emb.	Precio (€)
2 cables	2995	1	74,00
3 cables	2996	1	82,00



1190 89 82

Tapa detector de movimiento

Descripción	Referencia	Emb.	Precio (€)
Blanco, brillo	1190 89 82	1	3,93
Blanco polar, brillo	1190 89 89	1	3,93
Blanco polar, mate	1190 19 09	1	3,93
Antracita	1190 16 06	1	4,20
Aluminio	1190 14 04	1	7,29

Tapas para mecanismos



1288 19 29

Tapa para toma 15 polos

Descripción	Referencia	Emb.	Precio (€)
Blanco, brillo	1288 89 22	10	6,43
Blanco polar, brillo	1288 89 29	10	6,43
Blanco polar, mate	1288 19 29	10	7,24



1288 19 39

Tapa pulsador llamada/apagado con toma 15 polos

Descripción	Referencia	Emb.	Precio (€)
Blanco, brillo	1288 89 32	10	6,43
Blanco polar, brillo	1288 89 39	10	6,43
Blanco polar, mate	1288 19 39	10	7,24



1288 19 49

Tapa pulsador llamada / servicio / cancelar / doctor con toma 15 polos

Descripción	Referencia	Emb.	Precio (€)
Blanco, brillo	1288 89 42	10	6,43
Blanco polar, brillo	1288 89 49	10	6,43
Blanco polar, mate	1288 19 49	10	7,24



1288 19 09

Tapa para pulsador presencia / cancelar / personal / servicio / doctor

Descripción	Referencia	Emb.	Precio (€)
Blanco, brillo	1288 89 82	10	6,43
Blanco polar, brillo	1288 89 89	10	6,43
Blanco polar, mate	1288 19 09	10	7,24

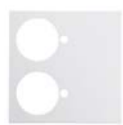

1288 19 19

Tapa para pulsador presencia, llamada / presencia, apagado, etc.

Descripción	Referencia	Emb.	Precio (€)
Blanco, brillo	1288 89 12	10	6,43
Blanco polar, brillo	1288 89 19	10	6,43
Blanco polar, mate	1288 19 19	10	7,24



1288 19 59

Tapa para pulsador neumático con indicador

Descripción	Referencia	Emb.	Precio (€)
Blanco, brillo	1288 89 52	10	14,34
Blanco polar, brillo	1288 89 59	10	14,31
Blanco polar, mate	1288 19 59	10	14,31



1288 19 69

Tapa para zumbador

Descripción	Referencia	Emb.	Precio (€)
Blanco polar, mate	1288 19 69	10	7,24

Tapas para mecanismos Ackermann



1204 99 09

Tapa terminación distribuidor datos / unidad vacía

Descripción	Referencia	Emb.	Precio (€)
Blanco, brillo	1204 89 82	10	5,71
Blanco polar, brillo	1204 89 89	10	5,71
Blanco polar, mate	1204 99 09	10	5,92



1298 99 09

Tapa unidad de conexión bus de datos con salida

Descripción	Referencia	Emb.	Precio (€)
Blanco, brillo	1298 89 82	10	6,43
Blanco polar, brillo	1298 89 89	10	6,43
Blanco polar, mate	1298 99 09	10	6,73



1305 99 19

Tapa conector enchufe y toma

Descripción	Referencia	Emb.	Precio (€)
Blanco, brillo	1305 89 82	10	21,22
Blanco polar, brillo	1305 89 89	10	21,17
Blanco polar, mate	1305 99 19	10	21,35



1244 99 09

Tapa 2 salidas e impresión

Descripción	Referencia	Emb.	Precio (€)
Blanco, brillo	1244 89 82	10	7,45
Blanco polar, brillo	1244 89 89	10	7,45
Blanco polar, mate	1244 99 09	10	7,75



1217 99 09

Tapa con pulsador de llamada rojo y salida

Descripción	Referencia	Emb.	Precio (€)
Blanco, brillo	1217 89 82	10	12,85
Blanco polar, brillo	1217 89 89	10	12,85
Blanco polar, mate	1217 99 09	10	13,26



1218 99 09

Tapa con pulsador de llamada rojo y 2 salidas

Descripción	Referencia	Emb.	Precio (€)
Blanco, brillo	1218 89 82	10	12,85
Blanco polar, brillo	1218 89 89	10	12,85
Blanco polar, mate	1218 99 09	10	15,91



1216 99 09

Tapa con pulsador de llamada rojo arriba

Descripción	Referencia	Emb.	Precio (€)
Blanco, brillo	1216 89 82	10	12,85
Blanco polar, brillo	1216 89 89	10	12,85
Blanco polar, mate	1216 99 09	10	13,26



1219 99 09

Tapa con pulsador de llamada rojo abajo

Descripción	Referencia	Emb.	Precio (€)
Blanco, brillo	1219 89 82	10	12,85
Blanco polar, brillo	1219 89 89	10	12,85
Blanco polar, mate	1219 99 09	10	13,26



1251 99 09

Tapa con pulsador de apagado verde abajo

Descripción	Referencia	Emb.	Precio (€)
Blanco, brillo	1251 89 82	10	12,85
Blanco polar, brillo	1251 89 89	10	12,85
Blanco polar, mate	1251 99 09	10	13,26



1252 99 09

Tapa con pulsador de apagado amarillo abajo

Descripción	Referencia	Emb.	Precio (€)
Blanco, brillo	1252 89 82	10	12,85
Blanco polar, brillo	1252 89 89	10	12,85
Blanco polar, mate	1252 99 09	10	13,26



1223 99 09

Tapa con pulsador de llamada a doctor en azul

Descripción	Referencia	Emb.	Precio (€)
Blanco, brillo	1223 89 82	10	12,85
Blanco polar, brillo	1223 89 89	10	12,85
Blanco polar, mate	1223 99 09	10	13,26



1308 99 09

Tapa con pulsador de confirmación blanco

Descripción	Referencia	Emb.	Precio (€)
Blanco, brillo	1308 89 82	10	12,85
Blanco polar, brillo	1308 89 89	10	12,85
Blanco polar, mate	1308 99 09	10	15,91



1249 99 09

Tapa pulsador rojo de llamada y verde de apagado

Descripción	Referencia	Emb.	Precio (€)
Blanco, brillo	1249 89 82	10	18,16
Blanco polar, brillo	1249 89 89	10	18,16
Blanco polar, mate	1249 99 09	10	18,87



1253 99 09

Tapa con pulsador verde y amarillo de apagado

Descripción	Referencia	Emb.	Precio (€)
Blanco, brillo	1253 89 82	10	18,26
Blanco polar, brillo	1253 89 89	10	18,26
Blanco polar, mate	1253 99 09	10	18,87



1299 99 09

Tapa pulsador verde presencia/blanco confirmación

Descripción	Referencia	Emb.	Precio (€)
Blanco, brillo	1299 89 82	10	18,26
Blanco polar, brillo	1299 89 89	10	18,16
Blanco polar, mate	1299 99 09	10	18,87



1236 99 09

Tapa para llamada neumática con indicador

Descripción	Referencia	Emb.	Precio (€)
Blanco, brillo	1236 89 82	10	6,43
Blanco polar, brillo	1236 89 89	10	6,43
Blanco polar, mate	1236 99 09	10	6,73



1233 99 09

Tapa para pulsador de tirador con indicador

Descripción	Referencia	Emb.	Precio (€)
Blanco, brillo	1233 89 82	10	6,43
Blanco polar, brillo	1233 89 89	10	6,43
Blanco polar, mate	1233 99 09	10	6,73



1300 99 09

Tapa sistema radio con pequeño sistema de sonido

Descripción	Referencia	Emb.	Precio (€)
Blanco, brillo	1300 89 82	10	7,45
Blanco polar, brillo	1300 89 89	10	7,45
Blanco polar, mate	1300 99 09	10	7,75



1301 89 82

Tapa sistema radio con pequeño sistema de sonido

Descripción	Referencia	Emb.	Precio (€)
Blanco, brillo	1301 89 82	10	7,45
Blanco polar, brillo	1301 89 89	10	7,45
Blanco polar, mate	1301 99 09	10	7,75

berker Q.7



Carácter diferencial

¿Infundir personalidad propia a tu hogar?

La elegante silueta de berker Q.7 se puede revestir con pizarra, hormigón, aluminio, vidrio o acero inoxidable ofreciendo nuevas posibilidades para que diseñes tu casa como quieras.

hager.es/berker

:hager



berker Q.1

Gracias a su superficie cuenta con un tacto inconfundible y único, así como con variantes de color muy atractivas en antracita, aluminio, blanco y blanco polar.

Con un perfil y ángulo de conmutación plano y contornos suavemente redondeados resulta poderosamente estético.

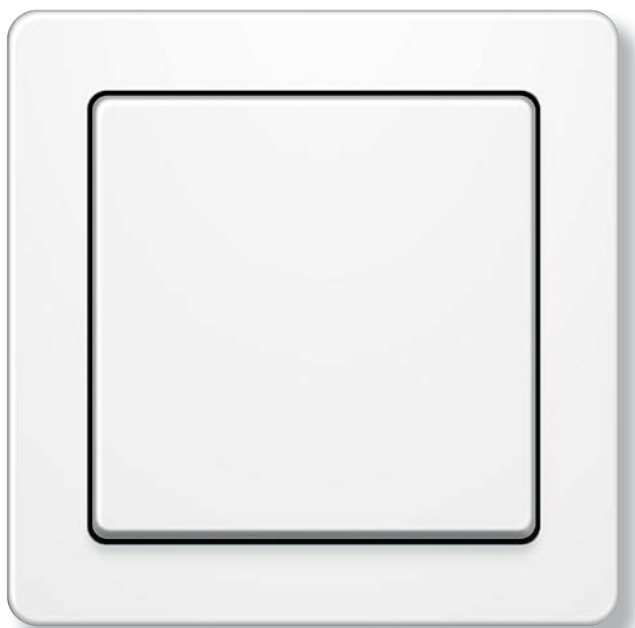

reddot design award
winner 2009

DESIGN PLUS





berker Q.3

Robustez. Cuesta pensar en una palabra que defina mejor berker Q.3. Sus claros contornos y su resistencia a los arañazos, convierten este interruptor en un fiel compañero. Cuenta con los mismos mecanismos que su programa hermano, berker Q.1. Asimismo, destaca por sus ventajas funcionales: berker Q.3 resulta especialmente indicado para la instalación en canal de distribución.





berker Q.7

La vivienda es siempre un reflejo de las personas que viven en ella. La forma geométrica de la gama berker Q.7 no engaña. Desde el primer instante, muestra similitudes con las gamas berker Q.1 y berker Q.3. Sin embargo, además de los materiales exclusivos, sus dimensiones también marcan la diferencia.



Marcos berker Q.1

NUEVO Marcos blanco

1011 60 82

Descripción	Referencia	Emb.	Precio (€)
1 elemento	1011 60 82	10	1,63
2 elementos	1012 60 82	10	3,06
3 elementos	1013 60 82	2	4,90
4 elementos	1014 60 82	2	6,83
5 elementos	1015 60 82	2	11,02

- Montaje vertical y horizontal



1011 60 89

Marcos blanco polar

Descripción	Referencia	Emb.	Precio (€)
1 elemento	1011 60 89	10	1,63
2 elementos	1012 60 89	10	3,06
3 elementos	1013 60 89	2	4,90
4 elementos	1014 60 89	2	6,83
5 elementos	1015 60 89	2	11,02

- Montaje vertical y horizontal



1012 60 86

Marcos antracita

Descripción	Referencia	Emb.	Precio (€)
1 elemento	1011 60 86	10	4,72
2 elementos	1012 60 86	10	6,85
3 elementos	1013 60 86	2	11,85
4 elementos	1014 60 86	2	18,84
5 elementos	1015 60 86	2	29,11

- Montaje vertical y horizontal

NUEVO Marcos aluminio

1012 60 84

Descripción	Referencia	Emb.	Precio (€)
1 elemento	1011 60 84	10	4,72
2 elementos	1012 60 84	10	6,85
3 elementos	1013 60 84	2	11,85
4 elementos	1014 60 84	2	18,84
5 elementos	1015 60 84	2	29,11

- Montaje vertical y horizontal

NUEVO Marcos colores personalizados (lateral)

1011 60 89C

Descripción	Referencia	Emb.	Precio (€)
1 elemento	1011 60 89C	1	4,72
2 elementos	1012 60 89C	1	6,85
3 elementos	1013 60 89C	1	11,85
4 elementos	1014 60 89C	1	18,84
5 elementos	1015 60 89C	1	29,11

- Personalización con el configurador online: <http://configurador.hager.es>



1011 60 62

Marcos rojo

Descripción	Referencia	Emb.	Precio (€)
1 elemento	1011 60 62	10	1,73
2 elementos	1012 60 62	10	3,37
3 elementos	1013 60 62	2	5,10
4 elementos	1014 60 62	2	7,14
5 elementos	1015 60 62	2	11,63

- Montaje vertical y horizontal
- Para resaltar interruptores especiales, tomas de corriente, ...
- Marco c/ portaetiquetas blanco

NUEVO

1011 60 12

Marcos c/portaetiquetas blanco

Descripción	Referencia	Emb.	Precio (€)
1 elemento	1011 60 12	10	4,83
2 elementos vertical	1012 60 12	10	27,63
3 elementos vertical	1013 60 12	10	38,39
4 elementos vertical	1014 60 12	2	50,49
5 elementos vertical	1015 60 12	2	64,49
2 elementos horizontal	1022 60 12	10	27,63
3 elementos horizontal	1023 60 12	10	38,39
4 elementos horizontal	1024 60 12	2	50,49
5 elementos horizontal	1025 60 12	2	64,49



1011 60 19

Marcos c/portaetiquetas blanco polar

Descripción	Referencia	Emb.	Precio (€)
1 elemento	1011 60 19	10	4,83
2 elementos vertical	1012 60 19	10	27,63
3 elementos vertical	1013 60 19	10	38,39
4 elementos vertical	1014 60 19	2	50,49
5 elementos vertical	1015 60 19	2	64,49
2 elementos horizontal	1022 60 19	10	27,63
3 elementos horizontal	1023 60 19	10	38,39
4 elementos horizontal	1024 60 19	2	50,49
5 elementos horizontal	1025 60 19	2	64,49

- Etiquetas de 6 mm alto



1011 60 16

Marcos c/portaetiquetas antracita

Descripción	Referencia	Emb.	Precio (€)
1 elemento	1011 60 16	10	10,67
2 elementos vertical	1012 60 16	10	31,40
3 elementos vertical	1013 60 16	10	43,83
4 elementos vertical	1014 60 16	2	57,51
5 elementos vertical	1015 60 16	2	73,76
2 elementos horizontal	1022 60 16	10	31,40
3 elementos horizontal	1023 60 16	10	43,83
4 elementos horizontal	1024 60 16	2	57,51
5 elementos horizontal	1025 60 16	2	73,76

- Etiquetas de 6 mm alto
- Marco c/ portaetiquetas blanco

NUEVO

1011 60 14

Marcos c/portaetiquetas aluminio

Descripción	Referencia	Emb.	Precio (€)
1 elemento	1011 60 14	10	10,67
2 elementos vertical	1012 60 14	10	31,40
3 elementos vertical	1013 60 14	10	43,83
4 elementos vertical	1014 60 14	2	57,51
5 elementos vertical	1015 60 14	2	73,76
2 elementos horizontal	1022 60 14	10	31,40
3 elementos horizontal	1023 60 14	10	43,83
4 elementos horizontal	1024 60 14	2	57,51
5 elementos horizontal	1025 60 14	2	73,76

- Etiquetas de 6 mm alto
- Marco c/ portaetiquetas blanco

Marcos para teclados KNX berker Q.1



1309 60 89

Descripción	Referencia	Emb.	Precio (€)
Blanco	1309 60 82	10	6,63
Blanco polar	1309 60 89	10	6,63
Antracita	1309 60 86	10	6,85
Aluminio	1309 60 84	10	6,85
Color personalizado	1309 60 89C	10	6,85

- Montaje vertical

Marcos berker Q.3

NUEVO

Marcos blanco



1011 60 92

Descripción	Referencia	Emb.	Precio (€)
1 elemento	1011 60 92	10	2,46
2 elementos	1012 60 92	2	3,06
3 elementos	1013 60 92	2	4,90
4 elementos	1014 60 92	2	6,83
5 elementos	1015 60 92	2	11,02

• Montaje vertical y horizontal

Marcos blanco polar



1011 60 99

Descripción	Referencia	Emb.	Precio (€)
1 elemento	1011 60 99	10	2,46
2 elementos	1012 60 99	2	3,06
3 elementos	1013 60 99	2	4,90
4 elementos	1014 60 99	2	6,83
5 elementos	1015 60 99	2	11,02

• Montaje vertical y horizontal

Marcos antracita



1012 60 96

Descripción	Referencia	Emb.	Precio (€)
1 elemento	1011 60 96	10	4,72
2 elementos	1012 60 96	10	6,85
3 elementos	1013 60 96	2	11,85
4 elementos	1014 60 96	2	18,84
5 elementos	1015 60 96	2	29,11

• Montaje vertical y horizontal

NUEVO

Marcos aluminio



1011 60 94

Descripción	Referencia	Emb.	Precio (€)
1 elemento	1011 60 94	10	4,72
2 elementos	1012 60 94	10	6,85
3 elementos	1013 60 94	2	11,85
4 elementos	1014 60 94	2	18,84
5 elementos	1015 60 94	2	29,11

• Montaje vertical y horizontal

NUEVO

Marcos c/portaetiquetas blanco



1051 60 92

Descripción	Referencia	Emb.	Precio (€)
1 elemento	1051 60 92	10	4,83
2 elementos vertical	1052 60 92	10	27,63
3 elementos vertical	1053 60 92	10	38,39
2 elementos horizontal	1022 60 92	10	27,63
3 elementos horizontal	1023 60 92	10	38,39

• Etiquetas de 6 mm alto

Marcos c/portaetiquetas blanco polar



1051 60 99

Descripción	Referencia	Emb.	Precio (€)
1 elemento	1051 60 99	10	4,83
2 elementos vertical	1052 60 99	10	27,63
3 elementos vertical	1053 60 99	10	38,39
2 elementos horizontal	1022 60 99	10	27,63
3 elementos horizontal	1023 60 99	10	38,39

• Etiquetas de 6 mm alto

NUEVO

Marcos c/portaetiquetas aluminio



1051 60 94

Descripción	Referencia	Emb.	Precio (€)
1 elemento	1051 60 94	10	4,83
2 elementos vertical	1052 60 94	10	27,63
3 elementos vertical	1053 60 94	10	38,39
2 elementos horizontal	1022 60 94	10	27,63
3 elementos horizontal	1023 60 94	10	38,39

Marcos para teclados KNX berker Q.3



1309 60 99

Descripción	Referencia	Emb.	Precio (€)
Blanco	1309 60 92	2	6,63
Blanco polar	1309 60 99	2	6,63
Antracita	1309 60 96	2	6,85
Aluminio	1309 60 94	2	6,85

• Montaje vertical

NUEVO**Marcos berker Q.7****Marcos blanco**

Descripción	Referencia	Emb.	Precio (€)
1 elemento	1011 61 82	10	3,00
2 elementos	1012 61 82	5	4,37
3 elementos	1013 61 82	5	7,53
4 elementos	1014 61 82	1	12,12
5 elementos	1015 61 82	1	18,45

1011 61 82

- Montaje vertical y horizontal
- Disponibilidad primer trimestre 2018

**Marcos blanco polar**

Descripción	Referencia	Emb.	Precio (€)
1 elemento	1011 61 89	10	3,00
2 elementos	1012 61 89	5	4,37
3 elementos	1013 61 89	5	7,53
4 elementos	1014 61 89	1	12,12
5 elementos	1015 61 89	1	18,45

1011 61 89

- Montaje vertical y horizontal
- Disponibilidad primer trimestre 2018

**Marcos antracita**

Descripción	Referencia	Emb.	Precio (€)
1 elemento	1011 61 86	10	4,00
2 elementos	1012 61 86	5	6,25
3 elementos	1013 61 86	5	10,06
4 elementos	1014 61 86	1	16,21
5 elementos	1015 61 86	1	24,66

1011 61 86

- Montaje vertical y horizontal
- Disponibilidad primer trimestre 2018

**Marcos aluminio**

Descripción	Referencia	Emb.	Precio (€)
1 elemento	1011 61 84	10	4,00
2 elementos	1012 61 84	10	6,25
3 elementos	1013 61 84	2	10,06
4 elementos	1014 61 84	2	16,21
5 elementos	1015 61 84	2	24,66

1011 61 84

- Montaje vertical y horizontal
- Disponibilidad primer trimestre 2018

**Marcos cristal, blanco polar**

Descripción	Referencia	Emb.	Precio (€)
1 elemento	1011 60 79	10	23,00
2 elementos	1012 60 79	10	40,61
3 elementos	1013 60 79	2	67,90
4 elementos	1014 60 79	2	92,87
5 elementos	1015 60 79	2	126,58

1011 60 79

- Montaje vertical y horizontal

**Marcos cristal, negro**

Descripción	Referencia	Emb.	Precio (€)
1 elemento	1011 60 76	10	23,00
2 elementos	1012 60 76	10	40,61
3 elementos	1013 60 76	2	67,90
4 elementos	1014 60 76	2	92,87
5 elementos	1015 60 76	2	126,58

1011 60 76

- Montaje vertical y horizontal

**Marcos aluminio mate**

Descripción	Referencia	Emb.	Precio (€)
1 elemento	1011 60 74	10	30,00
2 elementos	1012 60 74	10	52,97
3 elementos	1013 60 74	2	88,57
4 elementos	1014 60 74	2	121,14
5 elementos	1015 60 74	2	165,10

1011 60 74

- Montaje vertical y horizontal

**Marcos acero inoxidable cepillado**

Descripción	Referencia	Emb.	Precio (€)
1 elemento	1011 60 83	10	30,00
2 elementos vertical	1012 60 83	10	52,97
3 elementos vertical	1013 60 83	10	88,57
4 elementos vertical	1014 60 83	2	121,14
5 elementos vertical	1015 60 83	2	165,10
2 elementos horizontal	1022 60 83	10	52,97
3 elementos horizontal	1023 60 83	10	88,57
4 elementos horizontal	1024 60 83	2	121,14
5 elementos horizontal	1025 60 83	2	165,10

1011 60 83

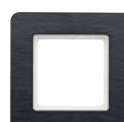
**Marcos pizarra natural**

Descripción	Referencia	Emb.	Precio (€)
1 elemento	1011 60 30	1	30,00
2 elementos vertical	1012 60 30	1	52,97
3 elementos vertical	1013 60 30	1	88,57

1011 60 30

**Marcos hormigón**

Descripción	Referencia	Emb.	Precio (€)
1 elemento	1011 60 20	1	30,00
2 elementos vertical	1012 60 20	1	52,97
3 elementos vertical	1013 60 20	1	88,57

1011 60 20

Marcos para teclados KNX berker Q.7

Descripción	Referencia	Emb.	Precio (€)
Blanco	1309 61 82	1	7,00
Blanco polar	1309 61 89	1	7,00
Antracita	1309 61 86	1	7,00
Aluminio	1309 61 84	1	7,00
Cristal blanco polar	1309 60 79	1	50,00
Cristal negro	1309 60 76	1	50,00
Aluminio pulido	1309 60 74	1	60,00
Acero inoxidable cepillado	1309 60 83	1	60,00
Pizarra	1309 60 30	1	60,00
Hormigón	1309 60 20	1	60,00

1309 61 89

- Montaje vertical
- No recomendado para montaje en cajas de superficie

Cajas para montaje en superficie



1029 00 69

Caja montaje en superficie 1 elemento

Descripción	Referencia	Emb.	Precio (€)
Blanco polar, brillo	1029 00 69	10	9,79
Antracita	1029 60 86	10	10,09
Rojo, brillo	1029 00 62	10	11,12

- Profundidad instalación 33,5 mm



1030 00 69

Caja montaje en superficie 2 elementos

Descripción	Referencia	Emb.	Precio (€)
Blanco polar, brillo	1030 00 69	10	10,50
Antracita	1030 60 86	10	17,32
Rojo, brillo	1030 00 62	10	15,40

- Profundidad instalación 33,5 mm



1031 00 69

Caja montaje en superficie 3 elementos

Descripción	Referencia	Emb.	Precio (€)
Blanco polar, brillo	1031 00 69	5	12,95
Antracita	1031 60 86	5	27,11
Rojo, brillo	1031 00 62	5	22,44

- Profundidad instalación 33,5 mm

Kits de sellado IP44 berker Q.x / K.x



1010 72 00

Para tomas SCHUKO y tapas

Descripción	Referencia	Emb.	Precio (€)
Transparente	1010 72 00	1	6,75



1010 71 00

Para tecla interruptor y pulsador

Descripción	Referencia	Emb.	Precio (€)
Transparente	1010 71 00	1	11,11



1010 70 00

Para interruptor/pulsador de llave

Descripción	Referencia	Emb.	Precio (€)
Transparente	1010 70 00	1	16,10

Tomas de corriente



1719 60 89

Tapa para SCHUKO

Descripción	Referencia	Emb.	Precio (€)
Blanco	1719 60 72	10	4,16
Blanco polar	1719 60 89	10	4,16
Antracita	1719 60 86	10	5,83
Aluminio	1719 60 74	10	5,83
Rojo	1719 60 12	10	4,24

- Añadir mecanismo ref. 714134
- Con protección infantil

Tapa para SCHUKO con tapa articulada

Descripción	Referencia	Emb.	Precio (€)
Blanco	1720 60 82	10	11,37
Blanco polar	1720 60 89	10	11,37
Antracita	1720 60 86	10	11,15
Aluminio	1720 60 84	10	11,15

- Añadir mecanismo ref. 714134



4149 60 89

Toma SCHUKO con portaetiquetas

Descripción	Referencia	Emb.	Precio (€)
Blanco	4149 60 82	10	10,61
Blanco polar	4149 60 89	10	10,61
Antracita	4149 60 86	10	10,61
Aluminio	4149 60 84	10	10,61

- 16A, 250 V~
- Con protección infantil
- Etiquetas de 6 mm alto
- Conexión tornillo



4109 60 89

Toma SCHUKO con LED de orientación

Descripción	Referencia	Emb.	Precio (€)
Blanco	4109 60 82	10	76,41
Blanco polar	4109 60 89	10	76,41
Antracita	4109 60 86	10	76,41
Aluminio	4109 60 84	10	76,41

- 16A, 250 V~
- Con protección infantil
- Conexión tornillo



4110 60 89

Toma SCHUKO con LED de control

Descripción	Referencia	Emb.	Precio (€)
Blanco	4110 60 82	10	65,78
Blanco polar	4110 60 89	10	65,78
Antracita	4110 60 86	10	65,78
Aluminio	4110 60 84	10	65,78

- 16A, 250 V~
- Con protección infantil
- Etiquetas de 6 mm alto
- Conexión tornillo

Teclas**Tecla**

1620 60 89

Descripción	Referencia	Emb.	Precio (€)
Blanco	1620 60 82	10	2,24
Blanco polar	1620 60 89	10	2,24
Antracita	1620 60 86	10	3,92
Aluminio	1620 60 84	10	3,92

Tecla con símbolo luz

1620 60 49

Descripción	Referencia	Emb.	Precio (€)
Blanco	1620 60 42	10	2,86
Blanco polar	1620 60 49	10	2,86
Antracita	1620 60 46	10	5,10
Aluminio	1620 60 44	10	5,10

Tecla con símbolo campana

1620 60 59

Descripción	Referencia	Emb.	Precio (€)
Blanco	1620 60 52	10	2,86
Blanco polar	1620 60 59	10	2,86
Antracita	1620 60 56	10	5,10
Aluminio	1620 60 54	10	5,10

Tecla con símbolo llave

1620 60 69

Descripción	Referencia	Emb.	Precio (€)
Blanco	1620 60 62	10	2,86
Blanco polar	1620 60 69	10	2,86
Antracita	1620 60 66	10	5,10
Aluminio	1620 60 64	10	5,10

Tecla con portaetiquetas

1626 60 89

Descripción	Referencia	Emb.	Precio (€)
Blanco	1626 60 82	10	8,77
Blanco polar	1626 60 89	10	8,77
Antracita	1626 60 86	10	9,53
Aluminio	1626 60 84	10	9,53

• Etiquetas de 6 mm alto

Tecla con 2 indicadores luminosos

1621 60 89

Descripción	Referencia	Emb.	Precio (€)
Blanco	1621 60 82	10	8,04
Blanco polar	1621 60 89	10	8,04
Antracita	1621 60 86	10	11,40
Aluminio	1621 60 84	10	11,40

• Indicador luminoso naranja y blanco

Tecla con 2 indicadores luminosos y símbolo luz

1621 60 79

Descripción	Referencia	Emb.	Precio (€)
Blanco	1621 60 72	10	9,14
Blanco polar	1621 60 79	10	9,14
Antracita	1621 60 76	10	11,69
Aluminio	1621 60 74	10	11,69

• Indicador luminoso naranja y blanco

Tecla con 2 indicadores luminosos y portaetiquetas

1628 60 89

Descripción	Referencia	Emb.	Precio (€)
Blanco	1628 60 82	10	9,69
Blanco polar	1628 60 89	10	9,69
Antracita	1628 60 86	10	14,87
Aluminio	1628 60 84	10	14,87

• Etiquetas de 6 mm alto

Tecla con 2 indicadores luminosos, portaetiquetas y símbolo campana

1628 60 79

Descripción	Referencia	Emb.	Precio (€)
Blanco	1628 60 72	10	9,69
Blanco polar	1628 60 79	10	9,69
Antracita	1628 60 76	10	14,38
Aluminio	1628 60 74	10	14,38

• Etiquetas de 6 mm alto en la parte inferior



1696 60 89

Tecla con 2 indicadores luminosos y portaetiquetas grande

Descripción	Referencia	Emb.	Precio (€)
Blanco	1696 60 82	10	9,69
Blanco polar	1696 60 89	10	9,69
Antracita	1696 60 86	10	16,05
Aluminio	1696 60 84	10	16,05

• Etiquetas de 2 x 18 mm alto



1696 60 79

Tecla con 2 indicadores luminosos, portaetiquetas grande y símbolo campana

Descripción	Referencia	Emb.	Precio (€)
Blanco	1696 60 72	10	13,92
Blanco polar	1696 60 79	10	13,92
Antracita	1696 60 76	10	14,03
Aluminio	1696 60 74	10	14,03

• Etiquetas de 2 x 18 mm alto



1622 60 89

Tecla con símbolo "0"

Descripción	Referencia	Emb.	Precio (€)
Blanco	1622 60 82	10	10,54
Blanco polar	1622 60 89	10	10,54
Antracita	1622 60 86	10	12,95
Aluminio	1622 60 84	10	12,95



1624 60 89

Tecla con símbolo "0" e indicador luminoso naranja

Descripción	Referencia	Emb.	Precio (€)
Blanco	1624 60 82	10	8,79
Blanco polar	1624 60 89	10	8,79
Antracita	1624 60 86	10	11,49
Aluminio	1624 60 84	10	11,49



1150 60 89

Tapa con mando para interruptores rotativos

Descripción	Referencia	Emb.	Precio (€)
Blanco polar	1150 60 89	1	15,50



1623 60 89

Tecla doble

Descripción	Referencia	Emb.	Precio (€)
Blanco	1623 60 82	10	5,92
Blanco polar	1623 60 89	10	5,92
Antracita	1623 60 86	10	6,79
Aluminio	1623 60 84	10	6,79



1627 60 89

Tecla doble con indicador luminoso

Descripción	Referencia	Emb.	Precio (€)
Blanco	1627 60 82	10	12,34
Blanco polar	1627 60 89	10	12,34
Antracita	1627 60 86	10	18,65
Aluminio	1627 60 84	10	18,65

• Indicador luminoso naranja y blanco



1665 60 89

Tecla para mecanismo triple ON/OFF

Descripción	Referencia	Emb.	Precio (€)
Blanco polar	1665 60 89	10	8,77

• Teclado triple ref. 6330 23



1625 60 89

Tecla doble persiana

Descripción	Referencia	Emb.	Precio (€)
Blanco	1625 60 82	10	6,63
Blanco polar	1625 60 89	10	6,63
Antracita	1625 60 86	10	9,14
Aluminio	1625 60 84	10	9,14

Teclas sin barreras



1661 60 49

Tecla simple con 2 indicadores luminosos

Descripción	Referencia	Emb.	Precio (€)
Blanco polar	1661 60 49	10	19,40



1651 60 49

Tecla simple con lente rojo y símbolo luz en relieve

Descripción	Referencia	Emb.	Precio (€)
Blanco polar	1651 60 49	10	17,39

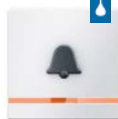

1651 60 59

Tecla simple con lente rojo y símbolo campana en relieve

Descripción	Referencia	Emb.	Precio (€)
Blanco polar	1651 60 59	10	17,32

Tapas



1640 60 89

Tapa tarjetero de hotel con indicador luminoso

Descripción	Referencia	Emb.	Precio (€)
Blanco	1640 60 82	10	39,98
Blanco polar	1640 60 89	10	39,98
Antracita	1640 60 86	10	40,71
Aluminio	1640 60 84	10	40,71

• Mecanismo ref.: 5051 02, 5051 03, 5052 01, 5056 01



1146 60 89

Tapa interruptor/pulsador tirador

Descripción	Referencia	Emb.	Precio (€)
Blanco	1146 60 82	10	6,63
Blanco polar	1146 60 89	10	6,63
Antracita	1146 60 86	10	8,03
Aluminio	1146 60 84	10	8,03



1084 60 82

Tapa para interruptor 3 posiciones con mando rotativo

Descripción	Referencia	Emb.	Precio (€)
Sin posición 0			
Blanco	1084 60 82	1	16,25
Blanco polar	1084 60 89	1	16,25
Antracita	1084 60 86	1	19,06
Aluminio	1084 60 84	1	19,06



1096 60 82

Con posición neutra

Blanco	1096 60 82	1	16,83
Blanco polar	1096 60 89	1	16,83
Antracita	1096 60 86	1	19,06
Aluminio	1096 60 84	1	19,06



1080 60 89

Tapa para interruptor/pulsador rotativo para persianas

Descripción	Referencia	Emb.	Precio (€)
Blanco	1080 60 82	1	16,26
Blanco polar	1080 60 89	1	16,26
Antracita	1080 60 86	1	19,35
Aluminio	1080 60 84	1	19,35



1081 60 89

Tapa con cerradura para interruptor de llave de persianas

Descripción	Referencia	Emb.	Precio (€)
Llave extraíble en posición media			
Blanco	1081 60 82	1	61,30
Blanco polar	1081 60 89	1	61,30
Antracita	1081 60 86	1	56,33
Aluminio	1081 60 84	1	56,33

• Función bloqueo función



1082 60 82

Tapa con cerradura para interruptor de llave de persianas

Descripción	Referencia	Emb.	Precio (€)
Llave extraíble en las 3 posiciones			
Blanco	1082 60 82	1	61,30
Blanco polar	1082 60 89	1	61,30
Antracita	1082 60 86	1	56,33
Aluminio	1082 60 84	1	56,33



1083 60 89

Tapa con cerradura para interruptor de llave de persianas

Descripción	Referencia	Emb.	Precio (€)
Llave extraíble en posición media			
Blanco	1083 60 82	1	61,30
Blanco polar	1083 60 89	1	61,30
Antracita	1083 60 86	1	56,33
Aluminio	1083 60 84	1	56,33

• Función solo pulsador



1506 60 89

Tapa para interruptor / pulsador de llave de persianas

Descripción	Referencia	Emb.	Precio (€)
Llave extraíble en posición media			
Blanco	1506 60 82	10	14,79
Blanco polar	1506 60 89	10	14,79
Antracita	1506 60 86	10	15,27
Aluminio	1506 60 84	10	15,27

• Con impresión

Blanco	1507 60 82	10	14,79
Blanco polar	1507 60 89	10	14,79
Antracita	1507 60 86	10	16,09
Aluminio	1507 60 84	10	16,09

• Sin impresión

Tapa interruptor protección diferencial



1493 19 09

Tapa central 50 x 50 mm para interruptor protección diferencial

Descripción	Referencia	Emb.	Precio (€)
Blanco polar, mate	1493 19 09	1	6,78
Antracita	1493 16 06	1	10,44

• Utilizar sólo con marcos intermedios para tapas centrales 50 x 50 mm de cada serie

Tapas ciegas



67 1009 60 89

Tapa ciega

Descripción	Referencia	Emb.	Precio (€)
Sin garras			
Blanco	1009 60 82	1	9,89
Blanco polar	1009 60 89	20	9,89
Antracita	1009 60 86	20	19,35
Aluminio	1009 60 84	1	19,35



67 1009 60 82

Con base y garras

Blanco	67 1009 60 82	1	9,89
Blanco polar	67 1009 60 89	10	9,89
Antracita	67 1009 60 86	10	11,75
Aluminio	67 1009 60 84	1	11,75



1009 60 79

Tapa ciega atornillada

Descripción	Referencia	Emb.	Precio (€)
Blanco	1009 60 72	20	12,14
Blanco polar	1009 60 79	20	12,14
Antracita	1009 60 76	20	14,21
Aluminio	1009 60 74	20	14,21

Señalización



1124 60 89

Tapa central para piloto / pulsador y lámpara E10

Descripción	Referencia	Emb.	Precio (€)
Blanco	1124 60 82	10	3,67
Blanco polar	1124 60 89	10	3,67
Antracita	1124 60 86	10	6,49
Aluminio	1124 60 84	10	6,49



1198 60 89

Tapa central para piloto, lámpara E14

Descripción	Referencia	Emb.	Precio (€)
Blanco	1198 60 82	10	12,27
Blanco polar	1198 60 89	10	12,27
Antracita	1198 60 86	10	12,95
Aluminio	1198 60 84	10	12,95

Temporizadores



1632 60 89

Tapa con mando rotativo para temporizador mecánico

Descripción	Referencia	Emb.	Precio (€)
Máximo 15 minutos			
Blanco polar	1632 60 89	1	15,71
Antracita	1632 60 86	1	20,89

Máximo 120 minutos

Blanco polar	1633 60 89	1	15,71
Antracita	1633 60 86	1	20,89



1674 60 89

Tapa con pulsador para relé temporizador

Descripción	Referencia	Emb.	Precio (€)
Blanco polar	1674 60 89	10	19,53



1735 60 89

Temporizador sencillo con pantalla

Descripción	Referencia	Emb.	Precio (€)
Blanco polar	1735 60 89	1	149,75
Antracita	1735 60 86	1	107,56



1736 60 89

Temporizador con pantalla

Descripción	Referencia	Emb.	Precio (€)
Blanco polar	1736 60 89	1	228,93
Antracita	1736 60 86	1	163,12

- Con impresión en alemán



1738 60 89

Temporizador con pantalla y conexión de sensor

Descripción	Referencia	Emb.	Precio (€)
Blanco polar	1738 60 89	1	275,60
Antracita	1738 60 86	1	196,03

- Con impresión en alemán

Tapa regulador rotativo

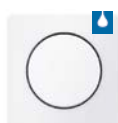

1137 60 89

Tapa central con mando rotativo para regulador rotativo

Descripción	Referencia	Emb.	Precio (€)
Blanco	1137 60 82	10	21,51
Blanco polar	1137 60 89	10	21,51
Antracita	1137 60 86	10	21,51
Aluminio	1137 60 84	10	21,51

Tapa control velocidad



1137 60 79

Tapa central con mando para control velocidad

Descripción	Referencia	Emb.	Precio (€)
Blanco	1137 60 72	10	23,24
Blanco polar	1137 60 79	10	23,24
Antracita	1137 60 76	10	23,24
Aluminio	1137 60 74	10	23,24

Tapa regulador universal



1765 60 89

Pulsador para regulador universal

Descripción	Referencia	Emb.	Precio (€)
Blanco polar	1765 60 89	1	124,66
Antracita	1765 60 86	1	124,66

Termostatos



2030 60 89

Termostato con contacto NC, interruptor y LED

Descripción	Referencia	Emb.	Precio (€)
Blanco	2030 60 82	1	90,98
Blanco polar	2030 60 89	1	90,98
Antracita	2030 60 86	1	100,10
Aluminio	2030 60 84	1	100,10



2026 60 89

Termostato con conmutador y tapa central

Descripción	Referencia	Emb.	Precio (€)
Blanco	2026 60 82	1	90,98
Blanco polar	2026 60 89	1	90,98
Antracita	2026 60 86	1	101,60
Aluminio	2026 60 84	1	101,60



2034 60 89

Termostato de suelo radiante

Descripción	Referencia	Emb.	Precio (€)
Blanco	2034 60 82	1	288,11
Blanco polar	2034 60 89	1	288,11
Antracita	2034 60 86	1	203,43
Aluminio	2034 60 84	1	203,43



7594 04 89

Tapa sensor

Descripción	Referencia	Emb.	Precio (€)
Blanco polar, mate	7594 04 89	1	3,59
Antracita	7594 04 85	1	9,22

- Utilizar sólo con marcos intermedios de la serie correspondiente
- Mecanismo ref: 7594 10 01
- Familia 96

Tarjetero hotel electrónico



1640 60 99

Tarjetero hotel electrónico

Descripción	Referencia	Emb.	Precio (€)
Blanco	1640 60 92	1	72,25
Blanco polar	1640 60 99	1	72,25
Antracita	1640 60 96	1	74,66
Aluminio	1640 60 94	1	74,66

Entretenimiento



2880 60 89

Radio

Descripción	Referencia	Emb.	Precio (€)
Blanco polar	2880 60 89	1	300,85
Aluminio	2880 60 84	1	300,85

- Incluye un altavoz

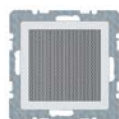

2882 60 89

Altavoz

Descripción	Referencia	Emb.	Precio (€)
Blanco polar	2882 60 89	1	58,78
Aluminio	2882 60 84	1	58,78

TV / Audio / Video



33 1532 60 89

Toma 3 x Cinch/S-Video

Descripción	Referencia	Emb.	Precio (€)
Blanco	33 1532 60 82	10	127,99
Blanco polar	33 1532 60 89	10	127,99
Antracita	33 1532 60 86	10	113,04
Aluminio	33 1532 60 84	10	113,04



33 1540 60 89

Toma VGA

Descripción	Referencia	Emb.	Precio (€)
Blanco	33 1540 60 82	10	64,08
Blanco polar	33 1540 60 89	10	64,08
Antracita	33 1540 60 86	10	90,58
Aluminio	33 1540 60 84	10	90,58



33 1541 60 89

Toma VGA con terminales a tornillo y mordaza

Descripción	Referencia	Emb.	Precio (€)
Blanco	33 1541 60 82	10	64,08
Blanco polar	33 1541 60 89	10	64,08
Antracita	33 1541 60 86	10	93,35
Aluminio	33 1541 60 84	10	93,35



33 1539 60 89

Toma USB / audio 3,5 mm

Descripción	Referencia	Emb.	Precio (€)
Blanco	33 1539 60 82	10	84,15
Blanco polar	33 1539 60 89	10	84,15
Antracita	33 1539 60 86	10	75,14
Aluminio	33 1539 60 84	10	75,14



33 1542 60 89

Toma alta definición

Descripción	Referencia	Emb.	Precio (€)
Blanco	33 1542 60 82	10	146,30
Blanco polar	33 1542 60 89	10	146,30
Antracita	33 1542 60 86	10	128,85
Aluminio	33 1542 60 84	10	128,85



33 1543 60 89

Toma alta definición con conexión 90°

Descripción	Referencia	Emb.	Precio (€)
Blanco	33 1543 60 82	10	146,30
Blanco polar	33 1543 60 89	10	146,30
Antracita	33 1543 60 86	10	128,85
Aluminio	33 1543 60 84	10	128,85



1412 19 09

Tapa central para conectores redondos XLR serie D

Descripción	Referencia	Emb.	Precio (€)
Blanco polar	1412 19 09	10	8,87
Antracita	1412 16 06	10	11,12



1196 60 89

Tapa central para toma altavoz y conector mini

Descripción	Referencia	Emb.	Precio (€)
Blanco	1196 60 82	10	6,32
Blanco polar	1196 60 89	10	6,32
Antracita	1196 60 86	10	7,66
Aluminio	1196 60 84	10	7,66



1203 60 89

Tapa central para toma TV 2 o 3 salidas

Descripción	Referencia	Emb.	Precio (€)
Blanco	1203 60 82	10	4,69
Blanco polar	1203 60 89	10	4,69
Antracita	1203 60 86	10	7,66
Aluminio	1203 60 84	10	7,66



1484 19 09

Tapa central para toma TV 4 salidas

Descripción	Referencia	Emb.	Precio (€)
Blanco polar	1484 19 09	10	3,98
Antracita	1484 16 06	10	6,63

- Utilizar sólo con marcos intermedios de la serie correspondiente
- Tomas TV de Ankaro, Astro, Axing, Delta, Schwaiger



1483 19 09

Tapa central para toma TV 4 salidas con tornillo

Descripción	Referencia	Emb.	Precio (€)
Blanco polar	1483 19 09	10	4,08
Antracita	1483 16 06	10	6,63

- Utilizar sólo con marcos intermedios de la serie correspondiente
- Tomas TV de Hirschmann

Marcos intermedios



1109 60 79

Anillo adaptador para tapa 50 x 50 mm

Descripción	Referencia	Emb.	Precio (€)
Blanco	1109 60 72	10	2,34
Blanco polar	1109 60 79	10	2,34
Antracita	1109 60 76	10	4,68
Aluminio	1109 60 74	10	4,68



1109 60 89

Marco intermedio para tapas centrales

Descripción	Referencia	Emb.	Precio (€)
Blanco	1109 60 82	10	2,34
Blanco polar	1109 60 89	10	2,34
Antracita	1109 60 86	10	4,40
Aluminio	1109 60 84	10	4,40



1905 00 69

Portaetiquetas para marco intermedio

Descripción	Referencia	Emb.	Precio (€)
Blanco polar, mate	1905 00 69	10	3,67

Tapa salida de cables



1019 60 89

Tapa central para salida de cable

Descripción	Referencia	Emb.	Precio (€)
Blanco	1019 60 82	10	6,32
Blanco polar	1019 60 89	10	6,32
Antracita	1019 60 86	10	7,66
Aluminio	1019 60 84	10	7,66

Tapas altavoz / datos / telecomunicaciones



1033 60 89

Tapa central para toma TAE y altavoz

Descripción	Referencia	Emb.	Precio (€)
Blanco	1033 60 82	10	3,26
Blanco polar	1033 60 89	10	3,26
Antracita	1033 60 86	10	7,66
Aluminio	1033 60 84	10	7,66



1407 60 89

Tapa central para toma teléfono / red

Descripción	Referencia	Emb.	Precio (€)
Blanco	1407 60 82	10	5,10
Blanco polar	1407 60 89	10	5,10
Antracita	1407 60 86	10	7,66
Aluminio	1407 60 84	10	7,66



1409 60 89

Capa central para toma teléfono / red doble

Descripción	Referencia	Emb.	Precio (€)
Blanco	1409 60 82	10	5,10
Blanco polar	1409 60 89	10	5,10
Antracita	1409 60 86	10	7,66
Aluminio	1409 60 84	10	7,66



1427 19 09

Capa central para 3 módulos MINI-COM

Descripción	Referencia	Emb.	Precio (€)
Blanco polar	1427 19 09	10	15,91
Antracita	1427 16 06	10	17,85



1463 19 09

Capa central para jack modular AMP

Descripción	Referencia	Emb.	Precio (€)
Blanco polar	1463 19 09	10	21,51
Antracita	1463 16 06	10	20,09

- Utilizar sólo con marcos intermedios de la serie correspondiente



1170 60 89

Capa central para jack modular Krone

Descripción	Referencia	Emb.	Precio (€)
Blanco polar	1464 19 09	10	21,51
Antracita	1464 16 06	10	20,09

- Utilizar sólo con marcos intermedios de la serie correspondiente



1170 60 89

Capa central c/protección de suciedad y portaetiquetas

Descripción	Referencia	Emb.	Precio (€)
Blanco	1170 60 82	10	7,96
Blanco polar	1170 60 89	10	7,96
Antracita	1170 60 86	10	12,31
Aluminio	1170 60 84	10	12,31



1181 60 89

Capa central con protección de suciedad y portaetiquetas doble

Descripción	Referencia	Emb.	Precio (€)
Blanco	1181 60 82	10	9,55
Blanco polar	1181 60 89	10	9,55
Antracita	1181 60 86	10	13,94
Aluminio	1181 60 84	10	13,94



1494 19 09

Capa central para AMP-ACO con portaetiquetas

Descripción	Referencia	Emb.	Precio (€)
Blanco polar, mate	1494 19 09	10	4,59

- Utilizar sólo con marcos intermedios de la serie correspondiente



1495 19 09

Capa central para AMP-ACO con portaetiquetas

Descripción	Referencia	Emb.	Precio (€)
Blanco polar, mate	1495 19 09	10	7,69

- Utilizar sólo con marcos intermedios de la serie correspondiente



1492 19 09

Capa central para acopladores de fibra óptica Simplex ST

Descripción	Referencia	Emb.	Precio (€)
Blanco polar, mate	1492 19 09	10	19,04

- Utilizar sólo con marcos intermedios de la serie correspondiente



1480 19 09

Capa central para acopladores de fibra óptica Duplex SC

Descripción	Referencia	Emb.	Precio (€)
Blanco polar, mate	1480 19 09	10	19,04

- Utilizar sólo con marcos intermedios de la serie correspondiente



1411 19 09

Capa central para conector 1 D-subminiatura

Blanco polar	1411 19 09	10	7,65
---------------------	------------	----	-------------

- Utilizar sólo con marcos intermedios de la serie correspondiente



1470 19 09

Capa central para conector 2 D-subminiatura

Descripción	Referencia	Emb.	Precio (€)
Blanco polar	1470 19 09	10	16,28

- Utilizar sólo con marcos intermedios de la serie correspondiente

Capa toma USB de carga

68 1033 60 89

Capa toma USB de carga

Descripción	Referencia	Emb.	Precio (€)
Blanco	68 1033 60 82	10	4,05
Blanco polar	68 1033 60 89	10	4,05
Antracita	68 1033 60 86	10	6,02
Aluminio	68 1033 60 84	10	6,02

Unidades de señalización y gestión

1431 19 09

Toma transmisión y control dispositivos 18,8 mm

Descripción	Referencia	Emb.	Precio (€)
Blanco polar, mate	1431 19 09	10	9,33
Antracita	1431 16 06	10	11,83

- Utilizar sólo con marcos intermedios de la serie correspondiente

Tapas sistemas hospitalarios

1403 19 09

Capa toma doble equipotencial

Descripción	Referencia	Emb.	Precio (€)
Blanco polar	1403 19 09	10	7,75
Antracita	1403 16 06	10	10,20



1474 19 09

Capa para toma 6 polos / timbre BBH01

Descripción	Referencia	Emb.	Precio (€)
Blanco	1474 02	10	6,63
Blanco polar	1474 19 09	10	7,24
Antracita	1474 14 06	10	8,57
Aluminio	1474 14 04	10	11,53

- Utilizar sólo con marcos intermedios correspondientes para BBH01:
1474 19 09 - Blanco polar
1474 16 06 - Antracita

Tapas para mecanismos Ackermann



Tapas terminación distribuidor datos / unidad vacía

Descripción	Referencia	Emb.	Precio (€)
Blanco polar	1204 60 89	10	5,92

1204 60 89



Tapas unidad de conexión bus de datos con salida

Descripción	Referencia	Emb.	Precio (€)
Blanco polar	1298 60 89	10	9,18

1298 60 89



Tapas conector enchufe y toma

Descripción	Referencia	Emb.	Precio (€)
Blanco polar	1305 60 89	10	9,18

1305 60 89



Tapas 2 salidas e impresión

Descripción	Referencia	Emb.	Precio (€)
Blanco polar	1244 60 89	10	11,24

1244 60 89



Tapas con pulsador de llamada rojo y salida

Descripción	Referencia	Emb.	Precio (€)
Blanco polar	1217 60 89	10	20,06

1217 60 89



Tapas con pulsador de llamada rojo y 2 salidas

Descripción	Referencia	Emb.	Precio (€)
Blanco polar	1218 60 89	10	18,70

1218 60 89



Tapas con pulsador de llamada rojo arriba

Descripción	Referencia	Emb.	Precio (€)
Blanco polar	1216 60 89	10	20,08

1216 60 89



Tapas con pulsador de llamada rojo abajo

Descripción	Referencia	Emb.	Precio (€)
Blanco polar	1219 60 89	10	18,14

1219 60 89



Tapas con pulsador de apagado verde abajo

Descripción	Referencia	Emb.	Precio (€)
Blanco polar	1251 60 89	10	17,86

1251 60 89



Tapas con pulsador de apagado amarillo abajo

Descripción	Referencia	Emb.	Precio (€)
Blanco polar	1252 60 89	10	17,81

1252 60 89



Tapas con pulsador de llamada a doctor en azul

Descripción	Referencia	Emb.	Precio (€)
Blanco polar	1223 60 89	10	18,41

1223 60 89



Tapas con pulsador de confirmación blanco

Descripción	Referencia	Emb.	Precio (€)
Blanco polar	1308 60 89	10	13,77

1308 60 89



Tapas c/pulsador rojo de llamada y verde de apagado

Descripción	Referencia	Emb.	Precio (€)
Blanco polar	1249 60 89	10	18,87

1249 60 89



Tapas con pulsador verde y amarillo de apagado

Descripción	Referencia	Emb.	Precio (€)
Blanco polar	1253 60 89	10	18,87

1253 60 89



Tapas con pulsador verde de presencia / blanco de confirmación

Descripción	Referencia	Emb.	Precio (€)
Blanco polar	1299 60 89	10	18,87

1299 60 89



Tapas para llamada neumática con indicador

Descripción	Referencia	Emb.	Precio (€)
Blanco polar	1236 60 89	10	13,68

1236 60 89



Tapas para pulsador de tirador con indicador

Descripción	Referencia	Emb.	Precio (€)
Blanco polar	1233 60 89	10	13,64

1233 60 89



Tapas para sistema radio con pequeño sistema de sonido

Descripción	Referencia	Emb.	Precio (€)
Blanco polar	1300 60 89	10	11,97

1300 60 89



Tapas para selector de programa de radio

Descripción	Referencia	Emb.	Precio (€)
Blanco polar	1301 60 89	10	11,97

1301 60 89



berker K.1

Menos es más - berker K.1 perfeccionó el arte del minimalismo. Ello lo convierte en la elección acertada para todos los interiores clásicos e intemporales.





berker K.5

Los claros contornos y la calidad del material determinan el aspecto cultivado en todo su conjunto del berker K.5. Tal vez un excelente ejemplo de ello: berker K.5 en elegante aluminio.

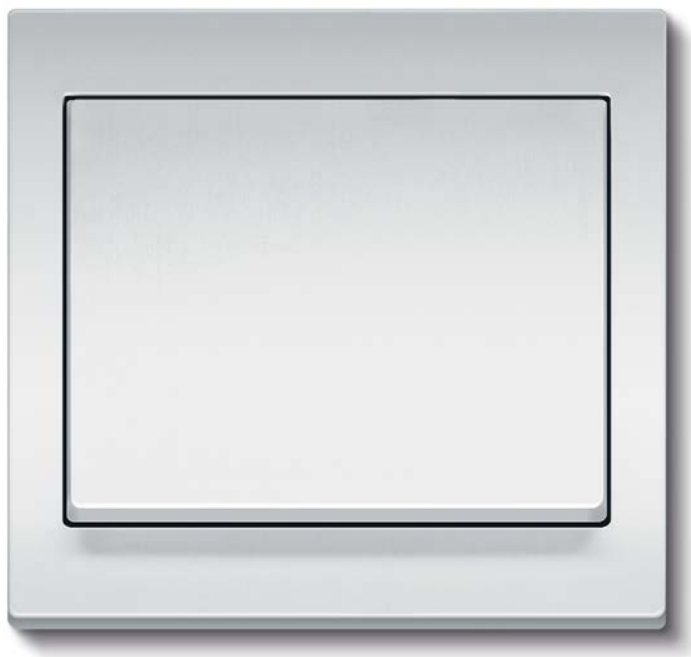

DESIGN PLUS
AWARD WINNER 2005



DESIGNPREIS
2007
NOMINIERT



GOLD
AWARD
Product
2012



Marcos



1313 70 09

Marcos K.1 blanco polar, brillo

Descripción	Referencia	Emb.	Precio (€)
1 elemento	1313 70 09	10	1,79
2 elementos vertical	1323 70 09	2	3,47
3 elementos vertical	1333 70 09	2	5,15
4 elementos vertical	1343 70 09	2	7,05
5 elementos vertical	1353 70 09	2	11,46
2 elementos horizontal	1363 70 09	2	3,47
3 elementos horizontal	1373 70 09	2	5,15
4 elementos horizontal	1383 70 09	2	7,05
5 elementos horizontal	1393 70 09	2	11,46

• Para protección IP44 utilizar ref. 1010 7..



1313 70 06

Marcos K.1 antracita

Descripción	Referencia	Emb.	Precio (€)
1 elemento	1313 70 06	10	3,47
2 elementos vertical	1323 70 06	10	5,00
3 elementos vertical	1333 70 06	2	8,05
4 elementos vertical	1343 70 06	2	13,05
5 elementos vertical	1353 70 06	2	18,24
2 elementos horizontal	1363 70 06	10	5,00
3 elementos horizontal	1373 70 06	2	8,05
4 elementos horizontal	1383 70 06	2	13,05
5 elementos horizontal	1393 70 06	2	18,24

• Para protección IP44 utilizar ref. 1010 7..



1313 70 04

Marcos K.5 acero

Descripción	Referencia	Emb.	Precio (€)
1 elemento	1313 70 04	10	9,49
2 elementos vertical	1323 70 04	2	14,38
3 elementos vertical	1333 70 04	2	31,21
4 elementos vertical	1343 70 04	2	37,94
5 elementos vertical	1353 70 04	2	59,67
2 elementos horizontal	1363 70 04	2	14,38
3 elementos horizontal	1373 70 04	2	31,21
4 elementos horizontal	1383 70 04	2	37,94
5 elementos horizontal	1393 70 04	2	59,67

• Para protección IP44 utilizar ref. 1010 ..



1313 70 03

Marcos K.5 aluminio

Descripción	Referencia	Emb.	Precio (€)
1 elemento	1313 70 03	10	9,49
2 elementos vertical	1323 70 03	2	14,38
3 elementos vertical	1333 70 03	2	31,21
4 elementos vertical	1343 70 03	2	37,94
5 elementos vertical	1353 70 03	2	59,67
2 elementos horizontal	1363 70 03	2	14,38
3 elementos horizontal	1373 70 03	2	31,21
4 elementos horizontal	1383 70 03	2	37,94
5 elementos horizontal	1393 70 03	2	59,67

• Para protección IP44 utilizar ref. 1010 ..

Marcos para teclados KNX



1309 70 09

Descripción	Referencia	Emb.	Precio (€)
Marco K.1, blanco polar, brillo	1309 70 09	1	6,83
Marco K.1, antracita	1309 70 06	1	8,47
Marco K.5, acero	1309 70 04	1	14,38
Marco K.5, aluminio	1309 70 03	1	14,38

• No es válido para montajes en superficie
• Montaje vertical

Cajas para montaje en superficie



1041 70 09

Caja montaje en superficie 1 elemento

Descripción	Referencia	Emb.	Precio (€)
Blanco polar, brillo	1041 70 09	10	14,51
Antracita	1041 70 06	10	14,69
Acero	1041 70 04	10	17,56
Aluminio	1041 70 03	10	17,56

• Profundidad instalación 36 mm



1042 70 09

Caja montaje en superficie 2 elementos vertical

Descripción	Referencia	Emb.	Precio (€)
Blanco polar, brillo	1042 70 09	5	21,98
Antracita	1042 70 06	5	23,15
Acero	1042 70 04	5	25,13
Aluminio	1042 70 03	5	25,13

• Profundidad instalación 36 mm



1043 70 09

Caja montaje en superficie 3 elementos vertical

Descripción	Referencia	Emb.	Precio (€)
Blanco polar, brillo	1043 70 09	5	34,70
Antracita	1043 70 06	5	36,21
Acero	1043 70 04	5	34,70
Aluminio	1043 70 03	5	34,70

• Profundidad instalación 36 mm



1052 70 09

Caja montaje en superficie 2 elementos horizontal

Descripción	Referencia	Emb.	Precio (€)
Blanco polar, brillo	1052 70 09	5	21,98
Antracita	1052 70 06	5	23,15
Acero	1052 70 04	5	25,13
Aluminio	1052 70 03	5	25,13

• Profundidad instalación 36 mm



1053 70 04

Caja montaje en superficie 3 elementos horizontal

Descripción	Referencia	Emb.	Precio (€)
Blanco polar, brillo	1053 70 09	5	34,70
Antracita	1053 70 06	5	36,21
Acero	1053 70 04	5	34,70
Aluminio	1053 70 03	5	34,70

• Profundidad instalación 36 mm

Kits de sellado IP44 K.x / Q.x



1010 72 00

Para tomas de corriente y tapa central

Descripción	Referencia	Emb.	Precio (€)
Transparente	1010 72 00	1	6,75



1010 71 00

Para tecla interruptor y pulsador

Descripción	Referencia	Emb.	Precio (€)
Transparente	1010 71 00	1	11,11



1010 70 00

Para interruptor de llave/ pulsador de llave

Descripción	Referencia	Emb.	Precio (€)
Transparente	1010 70 00	1	16,10

Tomas de corriente

Tapa para SCHUKO



1719 70 09

Descripción	Referencia	Emb.	Precio (€)
Blanco polar	1719 70 09	10	4,81
Antracita	1719 70 06	10	4,94
Acero	1719 70 04	10	8,71
Aluminio	1719 70 03	10	8,71
Rojo	1719 70 15	10	4,91

- Añadir mecanismo ref. 714134
- Con protección infantil

Tapa para SCHUKO con tapa articulada

Descripción	Referencia	Emb.	Precio (€)
Blanco polar	1720 72 09	10	11,15
Antracita	1720 72 06	10	11,37
Acero	1720 72 04	10	17,78
Aluminio	1720 72 03	10	17,78

- Añadir mecanismo ref. 714134

Toma SCHUKO con portaetiquetas



4738 70 09

Descripción	Referencia	Emb.	Precio (€)
Blanco polar, brillo	4738 70 09	10	13,35
Antracita	4738 70 06	10	13,87
Acero	4738 70 04	10	16,12
Aluminio	4738 70 03	10	16,12

- 16A, 250 V~
- Con protección infantil
- Etiquetas de 6 mm alto

Toma SCHUKO con indicador y portaetiquetas



4110 70 09

Descripción	Referencia	Emb.	Precio (€)
Blanco polar, brillo	4110 70 09	10	37,71

- 16A, 250 V~
- Lámpara de Neón 1,5mA
- Con protección infantil
- Etiquetas de 6 mm alto
- Conexión tornillos

Toma SCHUKO con LED de orientación



4109 70 09

Descripción	Referencia	Emb.	Precio (€)
Blanco polar, brillo	4109 70 09	10	73,97
Antracita	4109 70 06	10	76,04
Acero	4109 70 04	10	76,25
Aluminio	4109 70 03	10	77,39

- 16A, 250 V~
- Con protección infantil
- Conexión tornillos

NUEVO

Toma afeitar berker K.1



33 4476 70 09

Descripción	Referencia	Emb.	Precio (€)
Blanco polar	33 4476 70 09	10	91,00
Antracita	33 4476 70 16	10	92,82

Teclas

Tecla



1405 70 09

Descripción	Referencia	Emb.	Precio (€)
Blanco polar, brillo	1405 70 09	10	2,32
Antracita	1405 70 06	10	6,43
Acero	1405 70 04	10	6,53
Aluminio	1405 70 03	10	6,53

Tecla con portaetiquetas



1426 70 09

Descripción	Referencia	Emb.	Precio (€)
Blanco polar, brillo	1426 70 09	10	9,15
Antracita	1426 70 06	10	9,49
Acero	1426 70 04	10	9,59
Aluminio	1426 70 03	10	9,59

- Etiquetas de 6 mm alto

Tecla con 5 indicadores luminosos



1415 70 09

Descripción	Referencia	Emb.	Precio (€)
Blanco polar, brillo	1415 70 09	10	5,37
Antracita	1415 70 06	10	7,65
Acero	1415 70 04	10	10,54
Aluminio	1415 70 03	10	10,54

Tecla con 5 indicadores luminosos y portaetiquetas



1415 71 09

Descripción	Referencia	Emb.	Precio (€)
Blanco polar, brillo	1415 71 09	10	9,99
Antracita	1415 71 06	10	10,51
Acero	1415 71 04	10	10,71
Aluminio	1415 71 03	10	13,69

- Etiquetas de 6 mm alto

Tecla con 5 indicadores luminosos y portaetiquetas grande



1496 70 09

Descripción	Referencia	Emb.	Precio (€)
Blanco polar, brillo	1496 70 09	10	10,10
Antracita	1496 70 06	10	10,51
Acero	1496 70 04	10	10,71
Aluminio	1496 70 03	10	10,71

- Portaetiquetas 49,5 x 20,3 mm
- Etiquetas de 29 mm alto

Tecla con "0"



1425 71 09

Descripción	Referencia	Emb.	Precio (€)
Blanco polar, brillo	1425 71 09	10	4,20
Antracita	1425 71 06	10	7,65
Acero	1425 71 04	10	7,65
Aluminio	1425 71 03	10	7,65

Tecla con "0" e indicador luminoso



1417 71 09

Descripción	Referencia	Emb.	Precio (€)
Blanco polar, brillo	1417 71 09	10	5,37
Antracita	1417 71 06	10	8,67
Acero	1417 71 04	10	8,77
Aluminio	1417 71 03	10	8,77

Interruptor rotativo



1150 71 06

Descripción	Referencia	Emb.	Precio (€)
Blanco polar, brillo	1150 71 09	1	14,62
Antracita	1150 71 06	1	15,61
Acero	1150 71 04	1	16,32

Tecla doble



1435 70 09

Descripción	Referencia	Emb.	Precio (€)
Blanco polar, brillo	1435 70 09	10	6,20
Antracita	1435 70 06	10	9,08
Acero	1435 70 04	10	9,18
Aluminio	1435 70 03	10	16,33



Tecla doble con indicador luminoso

Descripción	Referencia	Emb.	Precio (€)
Blanco polar, brillo	1437 70 09	10	7,47
Antracita	1437 70 06	10	11,32
Acero	1437 70 04	10	11,32
Aluminio	1437 70 03	10	11,32

1437 70 09



Tecla para mecanismo triple ON/OFF

Descripción	Referencia	Emb.	Precio (€)
Blanco polar, brillo	1465 70 09	10	17,36
Antracita	1465 70 06	10	11,22
Acero	1465 70 04	10	17,01

1465 70 09

- Etiquetas de 6 mm. alto



Tecla doble persiana

Descripción	Referencia	Emb.	Precio (€)
Blanco polar, brillo	1435 71 09	10	7,36
Antracita	1435 71 06	10	11,32
Acero	1435 71 04	10	11,32
Aluminio	1435 71 03	10	11,32

1435 71 09

Teclas sin barreras



Tecla simple con 5 lentes

Descripción	Referencia	Emb.	Precio (€)
Blanco polar, brillo	1661 71 09	10	11,15

1661 71 09



Tecla simple con lente rojo y símbolo luz en relieve

Descripción	Referencia	Emb.	Precio (€)
Blanco polar, brillo	1651 71 09	10	10,30

1651 71 09



Tecla simple con lente rojo y símbolo campana en relieve

Descripción	Referencia	Emb.	Precio (€)
Blanco polar, brillo	1651 72 09	10	10,30

1651 72 09



Tecla simple con lente rojo y símbolo llave en relieve

Descripción	Referencia	Emb.	Precio (€)
Blanco polar, brillo	1651 73 09	10	10,30

1651 73 09

- Sin barreras basado en DIN 18025

Tapas



Tapa tarjetero de hotel con indicador luminoso

Descripción	Referencia	Emb.	Precio (€)
Blanco polar, brillo	1641 71 09	10	17,24
Antracita	1641 71 06	10	29,07
Acero	1641 71 04	10	31,93
Aluminio	1641 71 03	10	31,93

1641 71 09

- Mecanismo ref.: 5051 02, 5051 03, 5052 01, 5056 01



Tapa interruptor/pulsador tirador

Descripción	Referencia	Emb.	Precio (€)
Blanco polar, brillo	1147 70 09	10	6,94
Antracita	1147 70 06	10	7,75

1147 70 09



Tapa para interruptor 3 posiciones con mando rotativo

Descripción	Referencia	Emb.	Precio (€)
Sin posición 0			
Blanco polar, brillo	1088 71 09	1	10,83
Antracita	1088 71 06	1	13,97
Acero	1088 71 04	1	14,69
Aluminio	1088 71 03	1	14,69
Con posición neutra			
Blanco polar, brillo	1087 71 09	1	10,83
Antracita	1087 71 06	1	13,97
Acero	1087 71 04	1	14,69
Aluminio	1087 71 03	1	14,69

1088 71 09



Tapa para interruptor/pulsador rotativo para persianas

Descripción	Referencia	Emb.	Precio (€)
Blanco polar, brillo	1077 71 09	1	9,25
Antracita	1077 71 06	1	13,97
Acero	1077 71 04	1	14,69
Aluminio	1077 71 03	1	14,69

1077 71 09



Tapa con cerradura para interruptor de llave de persianas

Descripción	Referencia	Emb.	Precio (€)
Blanco polar, brillo	1079 71 09	1	63,20
Antracita	1079 71 06	1	65,99
Acero	1079 71 04	1	66,50
Aluminio	1079 71 03	1	66,50

1079 / 1 09



Llave extraíble en las 3 posiciones

Blanco polar, brillo	1079 72 09	1	63,20
Antracita	1079 72 06	1	65,99
Acero	1079 72 04	1	66,50
Aluminio	1079 72 03	1	66,50

1079 72 09

- Función bloqueo presión



Tapa con cerradura para interruptor de llave de persianas

Descripción	Referencia	Emb.	Precio (€)
Blanco polar, brillo	1079 73 09	1	63,20
Antracita	1079 73 06	1	65,99
Acero	1079 73 04	1	66,50
Aluminio	1079 73 03	1	66,50

1079 73 09

- Función sólo pulsador
- Llave extraíble en posición media



Tapa para interruptor / pulsador de llave de persianas

Descripción	Referencia	Emb.	Precio (€)
Blanco polar, brillo	1504 71 09	10	15,35
Antracita	1504 71 06	10	15,10
Acero	1504 71 04	10	19,79
Aluminio	1504 71 03	10	19,79

1504 71 09

- Con símbolo



Descripción	Referencia	Emb.	Precio (€)
Blanco polar, brillo	1505 70 09	10	15,35
Antracita	1505 70 06	10	15,10
Acero	1505 70 04	10	19,79
Aluminio	1505 70 03	10	19,79

1505 70 09

- Sin símbolo

Tapa interruptor protección diferencial



1493 19 09

Tapa central 50 x 50 mm para interruptor con protección diferencial

Descripción	Referencia	Emb.	Precio (€)
Blanco polar, brillo	1493 09	1	6,78
Antracita, mate	1493 16 06	1	10,44
Acero	1493 04	1	15,91
Blanco polar, mate	1493 19 09	1	6,78
Marrón, brillo	1493 01	1	11,96
Bronce	1493 11	1	18,18

- Utilizar sólo con marcos intermedios para tapas centrales 50 x 50 mm. de cada serie

Tapas ciegas



1045 70 09

Tapa ciega

Descripción	Referencia	Emb.	Precio (€)
Sin garras			
Blanco polar, brillo	1045 70 09	20	10,10
Antracita	1045 70 06	20	11,32
Acero	1045 70 04	20	14,38
Aluminio	1045 70 03	20	14,38

Con base y garras

Blanco polar, brillo	67 1045 70 09	10	10,30
Antracita	67 1045 70 06	10	11,55
Acero	67 1045 70 04	10	14,67
Aluminio	67 1045 70 03	10	14,67



1045 71 09

Tapa ciega atornillada

Descripción	Referencia	Emb.	Precio (€)
Blanco polar, brillo	1045 71 09	20	12,52
Antracita	1045 71 06	20	13,57

Señalización



1165 70 09

Tapa central para piloto / pulsador, lámpara E10

Descripción	Referencia	Emb.	Precio (€)
Blanco polar, brillo	1165 70 09	10	5,57
Antracita	1165 70 06	10	6,22
Acero	1165 70 04	10	9,08
Aluminio	1165 70 03	10	9,08



1167 70 09

Tapa central para piloto, lámpara E14

Blanco polar, brillo	1167 70 09	10	4,10
Antracita	1167 70 06	10	6,73
Acero	1167 70 04	10	9,59
Aluminio	1167 70 03	10	9,59

Temporizadores



1634 71 09

Tapa con mando rotativo p/temporizador mecánico

Descripción	Referencia	Emb.	Precio (€)
Máximo 15 minutos			
Blanco polar, brillo	1634 71 09	1	16,30
Antracita	1634 71 06	1	16,01
Acero	1634 71 04	1	17,95
Aluminio	1634 71 03	1	17,95



1635 71 09

Máximo 120 minutos

Blanco polar, brillo	1635 71 09	1	16,30
Antracita	1635 71 06	1	16,01
Acero	1635 71 04	1	17,95
Aluminio	1635 71 03	1	17,95



1735 70 06

Temporizador sencillo con pantalla

Descripción	Referencia	Emb.	Precio (€)
Blanco polar, brillo	1735 70 09	1	149,75
Antracita	1735 70 06	1	153,29
Acero	1735 70 04	1	172,45
Aluminio	1735 70 03	1	172,45



1736 71 09

Temporizador con pantalla

Descripción	Referencia	Emb.	Precio (€)
Blanco polar, brillo	1736 71 09	1	228,93
Antracita	1736 71 06	1	232,46
Acero	1736 71 04	1	251,62
Aluminio	1736 71 03	1	251,62

- Con impresión en alemán



1738 71 09

Temporizador con pantalla y conexión de sensor

Descripción	Referencia	Emb.	Precio (€)
Blanco polar, brillo	1738 71 09	1	275,81
Antracita	1738 71 06	1	279,39
Acero	1738 71 04	1	297,82
Aluminio	1738 71 03	1	297,82

- Con impresión en alemán

Tapa regulador rotativo



1135 70 09

Tapa central c/ mando rotativo para regulador rotativo

Descripción	Referencia	Emb.	Precio (€)
Blanco polar, brillo	1135 70 09	10	21,51
Antracita	1135 70 06	10	21,63
Acero	1135 70 04	10	40,19
Aluminio	1135 70 03	10	40,19

Tapa control velocidad



1135 72 09

Tapa central con mando para control velocidad

Descripción	Referencia	Emb.	Precio (€)
Blanco polar, brillo	1135 72 09	10	23,24
Antracita	1135 72 06	10	23,44
Acero	1135 72 04	10	41,95
Aluminio	1135 72 03	10	41,95

Tapa regulador universal



1765 70 09

Pulsador para regulador universal

Descripción	Referencia	Emb.	Precio (€)
Blanco polar, brillo	1765 70 09	1	39,16
Antracita	1765 70 06	1	39,61
Acero	1765 70 04	1	48,90
Aluminio	1765 70 03	1	48,90

Termostatos



2030 71 09

Termostato

Descripción	Referencia	Emb.	Precio (€)
Blanco polar, brillo	2030 71 09	1	91,80
Antracita	2030 71 06	1	96,90
Acero	2030 71 04	1	96,90
Aluminio	2030 71 03	1	96,90



2026 71 09

Termostato con conmutador

Descripción	Referencia	Emb.	Precio (€)
Blanco polar, brillo	2026 71 09	1	91,80
Antracita	2026 71 06	1	92,82
Acero	2026 71 04	1	96,90
Aluminio	2026 71 03	1	96,90



2034 71 09

Termostato de suelo radiante

Descripción	Referencia	Emb.	Precio (€)
Blanco polar, brillo	2034 71 09	1	288,11
Antracita	2034 71 06	1	292,46
Acero	2034 71 04	1	301,56
Aluminio	2034 71 03	1	301,56



7594 04 89

Tapa sensor

Descripción	Referencia	Emb.	Precio (€)
Blanco, brillo	7594 04 02	1	3,59
Blanco polar, brillo	7594 04 09	1	3,59
Blanco polar, mate	7594 04 89	1	3,59
Bronce	7594 04 04	1	13,90
Antracita	7594 04 85	1	9,22
Acero	7594 04 03	1	13,90
Aluminio	7594 04 83	1	11,10

- Utilizar sólo con marcos intermedios de la serie correspondiente
- Familia 96

Tarjetero hotel electrónico



1641 71 19

Tarjetero hotel electrónico

Descripción	Referencia	Emb.	Precio (€)
Blanco polar, brillo	1641 71 19	1	73,11
Antracita	1641 71 16	1	74,82
Acero	1641 71 14	1	78,81
Aluminio	1641 71 34	1	78,81

Entretenimiento



2880 70 09

Radio

Descripción	Referencia	Emb.	Precio (€)
Blanco polar, brillo	2880 70 09	1	299,63
Acero	2880 70 04	1	306,90
Aluminio	2880 70 03	1	306,90

- Incluye un altavoz



2882 70 09

Altavoz

Descripción	Referencia	Emb.	Precio (€)
Blanco polar, brillo	2882 70 09	1	58,27
Acero	2882 70 04	1	61,91
Aluminio	2882 70 03	1	61,91

TV / Audio / Video



33 1532 70 09

Toma 3 x Cinch/S-Video

Descripción	Referencia	Emb.	Precio (€)
Blanco polar, brillo	33 1532 70 09	10	129,85
Antracita	33 1532 70 06	10	139,88
Acero	33 1532 70 04	10	147,70
Aluminio	33 1532 70 03	10	147,70



33 1540 70 09

Toma VGA

Descripción	Referencia	Emb.	Precio (€)
Blanco polar, brillo	33 1540 70 09	10	65,89
Antracita	33 1540 70 06	10	71,48
Acero	33 1540 70 04	10	79,29
Aluminio	33 1540 70 03	10	79,29



33 1541 70 09

Toma VGA con terminales a tornillo y mordaza

Descripción	Referencia	Emb.	Precio (€)
Blanco polar, brillo	33 1541 70 09	10	65,89
Antracita	33 1541 70 06	10	71,48
Acero	33 1541 70 04	10	79,29
Aluminio	33 1541 70 03	10	79,29



33 1539 70 09

Toma USB / audio 3,5 mm

Descripción	Referencia	Emb.	Precio (€)
Blanco polar, brillo	33 1539 70 09	10	86,00
Antracita	33 1539 70 06	10	92,95
Acero	33 1539 70 04	10	100,77
Aluminio	33 1539 70 03	10	100,77



33 1542 70 09

Toma alta definición

Descripción	Referencia	Emb.	Precio (€)
Blanco polar, brillo	33 1542 70 09	1	148,10
Antracita	33 1542 70 06	1	159,42
Acero	33 1542 70 04	1	167,23
Aluminio	33 1542 70 03	10	167,23



33 1543 70 09

Toma alta definición con conexión 90°

Descripción	Referencia	Emb.	Precio (€)
Blanco polar, brillo	33 1543 70 09	10	148,10
Antracita	33 1543 70 06	10	159,42
Acero	33 1543 70 04	10	167,23
Aluminio	33 1543 70 03	10	167,23

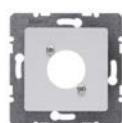

1412 19 09

Tapa central para conectores redondos XLR serie D

Descripción	Referencia	Emb.	Precio (€)
Blanco polar, brillo	1412 09	10	7,96
Antracita	1412 16 06	10	11,12
Acero	1412 19 09	10	8,87



1184 70 09

Tapa central para toma altavoz y conector mini

Descripción	Referencia	Emb.	Precio (€)
Blanco polar, brillo	1184 70 09	10	6,62
Antracita	1184 70 06	10	7,45
Acero	1184 70 04	10	10,51
Aluminio	1184 70 03	10	10,51



1201 70 19

Tapa central para toma TV 2 ó 3 salidas

Descripción	Referencia	Emb.	Precio (€)
Blanco polar, brillo	1201 70 19	10	4,95
Antracita	1201 70 16	10	7,45
Acero	1201 70 14	10	9,89
Aluminio	1201 70 13	10	9,89



1484 09

Tapas centrales para toma TV 4 salidas

Descripción	Referencia	Emb.	Precio (€)
Blanco polar, brillo	1484 09	10	4,08
Antracita	1484 16 06	10	6,63
Acero	1484 04	10	10,61
Blanco polar, mate	1484 19 09	10	3,98
Marrón	1484 01	10	8,77
Bronce	1484 11	10	10,61

- Utilizar sólo con marcos intermedios de la serie correspondiente
- Tomas TV de Ankaro, Astro, Axing, Delta, Schwaiger



1483 09

Tapas centrales para toma TV 4 salidas con tornillo

Descripción	Referencia	Emb.	Precio (€)
Blanco polar, brillo	1483 09	10	3,77
Antracita	1483 16 06	10	6,63
Acero	1483 04	10	13,16
Blanco polar, mate	1483 19 09	10	4,08
Marrón	1483 01	10	8,87
Bronce	1483 11	10	10,61

- Utilizar sólo con marcos intermedios de la serie correspondiente
- Tomas TV de Hirschmann

Marcos intermedios



1108 71 09

Anillo adaptador para tapa 50 x 50 mm

Descripción	Referencia	Emb.	Precio (€)
Blanco polar, brillo	1108 71 09	10	2,73
Antracita	1108 71 06	10	3,83
Acero	1108 71 04	10	4,79
Aluminio	1108 71 03	10	4,79



1108 70 09

Marco intermedio para tapas centrales

Descripción	Referencia	Emb.	Precio (€)
Blanco polar, brillo	1108 70 09	10	2,73
Antracita	1108 70 06	10	4,09
Acero	1108 70 04	10	5,19
Aluminio	1108 70 03	10	5,19



1905 00 69

Portaetiquetas para marco intermedio

Descripción	Referencia	Emb.	Precio (€)
Blanco polar, brillo	1905 00 69	10	3,67
Acero	1905 70 04	10	6,07
Aluminio	1905 70 03	10	6,07



1154 71 09

Anillo adaptador con tapa y portaetiquetas para tapa 50 x 50 mm

Descripción	Referencia	Emb.	Precio (€)
Blanco polar, brillo	1154 71 09	10	10,10
Antracita	1154 71 06	10	13,26
Acero	1154 71 04	10	21,54
Aluminio	1154 71 03	10	21,54

Tapas salida de cables



1005 70 09

Descripción	Referencia	Emb.	Precio (€)
Blanco polar, brillo	1005 70 09	10	6,31
Antracita	1005 70 06	10	7,45
Acero	1005 70 04	10	10,51
Aluminio	1005 70 03	10	10,51

Tapas altavoz / datos / telecomunicaciones



1035 70 09

Tapas centrales para toma TAE y altavoz

Descripción	Referencia	Emb.	Precio (€)
Blanco polar, brillo	1035 70 09	10	3,37
Antracita	1035 70 06	10	7,45
Acero	1035 70 04	10	10,51
Aluminio	1035 70 03	10	10,51



1458 09

Tapas centrales para toma TAE 6/6FFy 6/6NF y altavoz

Descripción	Referencia	Emb.	Precio (€)
Blanco polar, brillo	1458 09	10	3,77
Marrón	1458 01	10	8,77



1407 70 09

Tapas centrales para toma teléfono / red

Descripción	Referencia	Emb.	Precio (€)
Blanco polar, brillo	1407 70 09	10	5,25
Antracita	1407 70 06	10	5,92
Acero	1407 70 04	10	8,36
Aluminio	1407 70 03	10	8,36



1468 09

Tapas centrales para toma teléfono / red

Descripción	Referencia	Emb.	Precio (€)
Blanco polar, brillo	1468 09	10	2,86
Marrón	1468 01	10	8,77

- Utilizar sólo con marcos intermedios de la serie correspondiente



1409 70 09

Tapas centrales para toma teléfono / red doble

Descripción	Referencia	Emb.	Precio (€)
Blanco polar, brillo	1409 70 09	10	6,52
Antracita	1409 70 06	10	7,45
Acero	1409 70 04	10	10,51
Aluminio	1409 70 03	10	10,51



1469 09

Tapas centrales para toma teléfono / red doble

Descripción	Referencia	Emb.	Precio (€)
Blanco polar, brillo	1469 09	10	4,18
Marrón	1469 01	10	8,77

- Utilizar sólo con marcos intermedios de la serie correspondiente



1170 70 09

Tapas centrales con protección de suciedad y portaetiquetas simple

Descripción	Referencia	Emb.	Precio (€)
Blanco polar, brillo	1170 70 09	10	9,78
Antracita	1170 70 06	10	11,83
Acero	1170 70 04	10	14,89
Aluminio	1170 70 03	10	14,89



1182 70 09

Tapas centrales con protección de suciedad y portaetiquetas doble

Descripción	Referencia	Emb.	Precio (€)
Blanco polar, brillo	1182 70 09	10	11,88
Antracita	1182 70 06	10	13,36
Acero	1182 70 04	10	17,14
Aluminio	1182 70 03	10	17,14



1494 09

Tapas centrales para AMP-ACO

Descripción	Referencia	Emb.	Precio (€)
Blanco polar, brillo	1494 09	10	4,18
Antracita	1494 16 06	10	6,63
Acero	1494 19 09	10	4,59

- Utilizar sólo con marcos intermedios de la serie correspondiente
- Portaetiquetas no disponible



1495 09

Tapa central para AMP-ACO con portaetiquetas

Descripción	Referencia	Emb.	Precio (€)
Blanco polar, brillo	1495 09	10	6,43
Antracita	1495 16 06	10	8,87
Acero	1495 19 09	10	7,69

- Utilizar sólo con marcos intermedios de la serie correspondiente



1492 09

Tapa central para acopladores de fibra óptica Simplex ST

Descripción	Referencia	Emb.	Precio (€)
Blanco polar, brillo	1492 09	10	16,22

- Utilizar sólo con marcos intermedios de la serie correspondiente



1480 09

Tapa central para acopladores de fibra óptica Duplex SC

Descripción	Referencia	Emb.	Precio (€)
Blanco polar, brillo	1480 09	10	16,73

- Utilizar sólo con marcos intermedios de la serie correspondiente



1411 19 09

Tapa central para conector 1 D-subminiatura

Descripción	Referencia	Emb.	Precio (€)
Blanco polar, brillo	1411 09	10	7,55

- Utilizar sólo con marcos intermedios de la serie correspondiente



1470 19 09

Tapa central para conector 2 D-subminiatura

Descripción	Referencia	Emb.	Precio (€)
Blanco polar, brillo	1470 09	10	15,07

- Utilizar sólo con marcos intermedios de la serie correspondiente

Tapa toma USB de carga



68 1034 70 09

Tapa toma USB de carga

Descripción	Referencia	Emb.	Precio (€)
Blanco polar	68 1034 70 09	10	4,20
Antracita	68 1034 70 06	10	6,80
Acero	68 1034 70 04	10	10,00
Aluminio	68 1034 70 03	10	10,00

Unidades de señalización y gestión



1431 09

Tapa transmisión y control de dispositivo 18,8 mm

Descripción	Referencia	Emb.	Precio (€)
Blanco polar, brillo	1431 09	10	7,85
Antracita	1431 16 06	10	11,83
Acero	1431 04	10	16,42
Aluminio	1431 70 03	10	9,33

- Utilizar sólo con marcos intermedios de la serie correspondiente

Tapas sistemas hospitalarios



1403 19 09

Tapa toma doble equipotencial

Descripción	Referencia	Emb.	Precio (€)
Blanco polar, brillo	1403 09	10	7,85
Antracita	1403 16 06	10	10,20

- Mecanismo ref.: 1061



1474 09

Tapa para toma 6 polos/ Timbre BBH01

Descripción	Referencia	Emb.	Precio (€)
Blanco polar, brillo	1474 09	10	6,63
Antracita	1474 16 06	10	8,57
Acero	1474 04	10	20,60

- Utilizar sólo con marcos intermedios correspondientes para BBH01:

1108 70 09 - Blanco polar brillo
 1108 70 06 - Antracita
 1108 70 04 - Acero
 1108 70 03 - Aluminio

Tapas para mecanismos Ackermann



Tapa terminación distribuidor datos / unidad vacía

Descripción	Referencia	Emb.	Precio (€)
Blanco polar, brillo	1204 70 09	10	6,20

1204 70 09



Tapa unidad de conexión bus de datos con salida

Descripción	Referencia	Emb.	Precio (€)
Blanco polar, brillo	1298 70 09	10	9,57

1298 70 09



Tapa conector enchufe y toma

Descripción	Referencia	Emb.	Precio (€)
Blanco polar, brillo	1305 70 09	10	21,60

1305 70 09



Tapa 2 salidas e impresión

Descripción	Referencia	Emb.	Precio (€)
Blanco polar, brillo	1244 71 09	10	8,10

1244 71 09



Tapa con pulsador de llamada rojo y salida

Descripción	Referencia	Emb.	Precio (€)
Blanco polar, brillo	1217 70 09	10	13,67

1217 70 09



Tapa con pulsador de llamada rojo y 2 salidas

Descripción	Referencia	Emb.	Precio (€)
Blanco polar, brillo	1218 71 09	10	14,30

1218 71 09



Tapa con pulsador de llamada rojo arriba

Descripción	Referencia	Emb.	Precio (€)
Blanco polar, brillo	1216 70 09	10	14,30

1216 70 09



Tapa con pulsador de llamada rojo abajo

Descripción	Referencia	Emb.	Precio (€)
Blanco polar, brillo	1219 70 09	10	14,30

1219 70 09



Tapa con pulsador de apagado verde abajo

Descripción	Referencia	Emb.	Precio (€)
Blanco polar, brillo	1251 70 09	10	14,30

1251 70 09



Tapa con pulsador de apagado amarillo abajo

Descripción	Referencia	Emb.	Precio (€)
Blanco polar, brillo	1252 70 09	10	14,30

1252 70 09



Tapa con pulsador de llamada a doctor en azul

Descripción	Referencia	Emb.	Precio (€)
Blanco polar, brillo	1223 71 09	10	14,30

1223 71 09



Tapa con pulsador rojo de llamada y verde de apagado

Descripción	Referencia	Emb.	Precio (€)
Blanco polar, brillo	1249 70 09	10	19,56

1249 70 09



Tapa con pulsador verde y amarillo de apagado

Descripción	Referencia	Emb.	Precio (€)
Blanco polar, brillo	1253 70 09	10	19,56

1253 70 09



Tapa con pulsador verde de presencia / blanco de confirmación

Descripción	Referencia	Emb.	Precio (€)
Blanco polar, brillo	1299 71 09	10	19,56

1299 71 09



Tapa para llamada neumática con indicador

Descripción	Referencia	Emb.	Precio (€)
Blanco polar, brillo	1236 70 09	10	7,05

1236 70 09



Tapa para pulsador de tirador con indicador

Descripción	Referencia	Emb.	Precio (€)
Blanco polar, brillo	1233 70 09	10	7,05

1233 70 09



Tapa para sistema radio con pequeño sistema de sonido

Descripción	Referencia	Emb.	Precio (€)
Blanco polar, brillo	1300 71 09	10	8,20

1300 71 09



Tapa para selector de programa de radio

Descripción	Referencia	Emb.	Precio (€)
Blanco polar, brillo	1301 71 09	10	8,20

1301 71 09

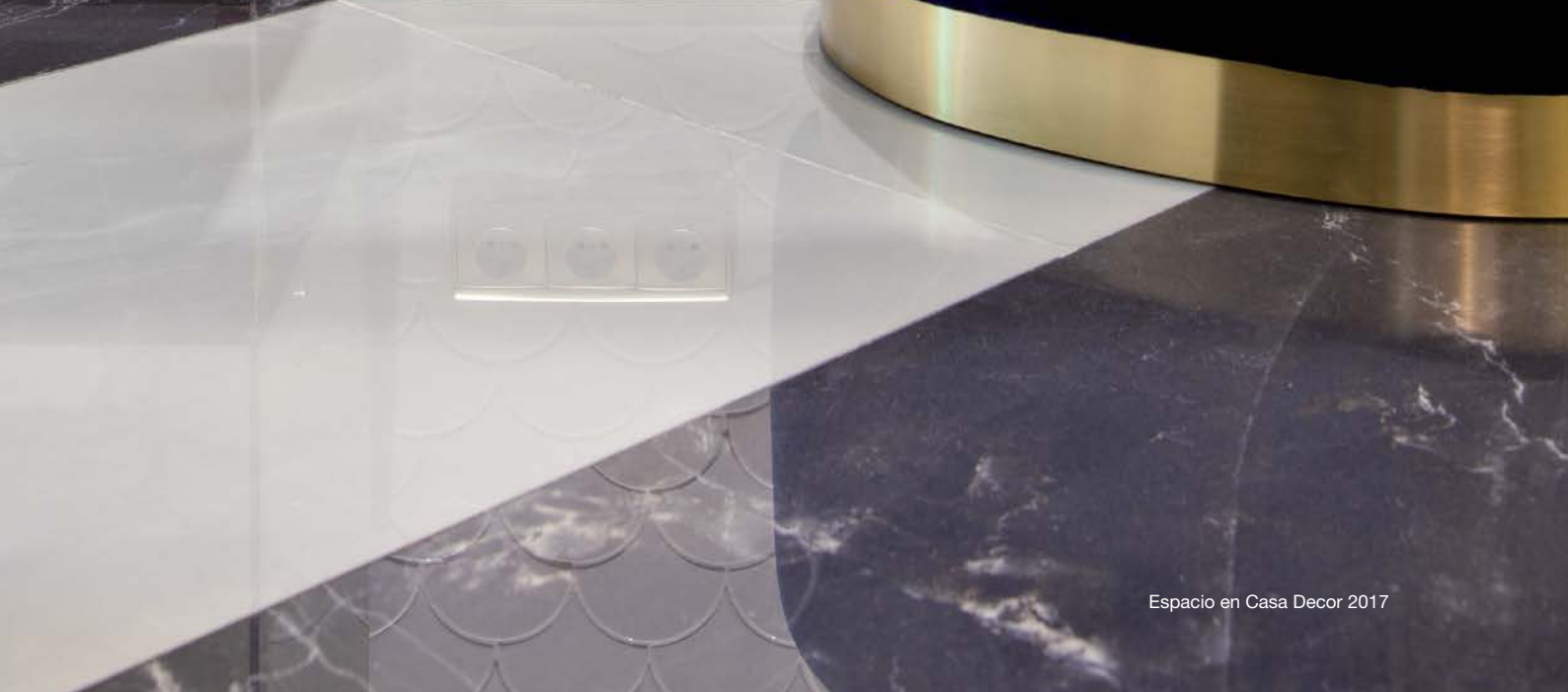

berker Arsys

Cada edificio es diferente. Cada interior es resultado de preferencias individuales. Así, el diseño del interruptor debe ser igualmente único. berker Arsys se adapta perfectamente a cualquier ambiente gracias a la gran variedad de materiales y tipos de superficie en que se puede adquirir. Al mismo tiempo, se mantiene fiel a sí mismo.



Arsys Kupfer Med

Marcos



1313 00 02

Marcos blanco, brillo

Descripción	Referencia	Emb.	Precio (€)
1 elemento	1313 00 02	10	1,84
2 elementos vertical	1323 00 02	2	3,37
3 elementos vertical	1333 00 02	2	5,30
4 elementos vertical	1343 00 02	2	7,45
5 elementos vertical	1353 00 02	2	12,34
2 elementos horizontal	1363 00 02	2	3,37
3 elementos horizontal	1373 00 02	2	5,30
4 elementos horizontal	1383 00 02	2	7,45
5 elementos horizontal	1393 00 02	2	12,34



1313 00 69

Marcos blanco polar, brillo

Descripción	Referencia	Emb.	Precio (€)
1 elemento	1313 00 69	10	1,84
2 elementos vertical	1323 00 69	2	3,37
3 elementos vertical	1333 00 69	2	5,30
4 elementos vertical	1343 00 69	2	7,45
5 elementos vertical	1353 00 69	2	12,34
2 elementos horizontal	1363 00 69	2	3,37
3 elementos horizontal	1373 00 69	2	5,30
4 elementos horizontal	1383 00 69	2	7,45
5 elementos horizontal	1393 00 69	2	12,34



1313 00 01

Marcos marrón, brillo

Descripción	Referencia	Emb.	Precio (€)
1 elemento	1313 00 01	10	2,35
2 elementos vertical	1323 00 01	2	3,98
3 elementos vertical	1333 00 01	2	6,73
4 elementos vertical	1343 00 01	2	9,79
5 elementos vertical	1353 00 01	2	14,18
2 elementos horizontal	1363 00 01	2	3,98
3 elementos horizontal	1373 00 01	2	6,73
4 elementos horizontal	1383 00 01	2	9,49
5 elementos horizontal	1393 00 01	2	14,18



1314 00 01

Marcos bronce, metal

Descripción	Referencia	Emb.	Precio (€)
1 elemento	1314 00 01	10	6,12
2 elementos vertical	1324 00 01	2	11,27
3 elementos vertical	1334 00 01	2	29,35
4 elementos vertical	1344 00 01	2	45,21
5 elementos vertical	1354 00 01	2	66,76
2 elementos horizontal	1364 00 01	2	11,27
3 elementos horizontal	1374 00 01	2	29,35
4 elementos horizontal	1384 00 01	2	45,21
5 elementos horizontal	1394 00 01	2	66,76



1314 00 04

Marcos acero

Descripción	Referencia	Emb.	Precio (€)
1 elemento	1314 00 04	10	6,94
2 elementos vertical	1324 00 04	2	11,32
3 elementos vertical	1334 00 04	2	31,42
4 elementos vertical	1344 00 04	2	42,53
5 elementos vertical	1354 00 04	2	60,49
2 elementos horizontal	1364 00 04	2	11,32
3 elementos horizontal	1374 00 04	2	31,42
4 elementos horizontal	1384 00 04	2	42,53
5 elementos horizontal	1394 00 04	2	60,49



1314 00 02

Marcos dorado

Descripción	Referencia	Emb.	Precio (€)
1 elemento	1314 00 02	10	6,12
2 elementos vertical	1324 00 02	2	11,27
3 elementos vertical	1334 00 02	2	29,35
4 elementos vertical	1344 00 02	2	45,21
5 elementos vertical	1354 00 02	2	66,76
2 elementos horizontal	1364 00 02	2	11,27
3 elementos horizontal	1374 00 02	2	29,35
4 elementos horizontal	1384 00 02	2	45,21
5 elementos horizontal	1394 00 02	2	66,76



1313 00 62

Marcos rojo, brillo

Descripción	Referencia	Emb.	Precio (€)
1 elemento	1313 00 62	10	6,12
2 elementos vertical	1323 00 62	2	10,00
2 elementos horizontal	1363 00 62	2	10,00



1056 00

Anillo sellado para instalación empotrada

Descripción	Referencia	Emb.	Precio (€)
Negro, marco 1 elemento	1056 00	10	3,06
Negro, marco 2 elementos	1057 00	2	5,71
Negro, marco 3 elementos	1058 00	2	6,32

- Para montaje en vertical y horizontal

Cajas para montaje en superficie



1029 00 69

Caja montaje en superficie, 1 elemento

Descripción	Referencia	Emb.	Precio (€)
Blanco polar, brillo	1029 00 69	10	9,79
Marrón, brillo	1029 00 01	10	10,81
Bronce, metal	1029 90 11	10	19,89
Acero	1029 90 04	10	19,89
Rojo, brillo	1029 00 62	10	11,12
Negro, brillo	1029 00 65	10	11,53

- Profundidad instalación 33,5 mm



1030 00 69

Caja montaje en superficie, 2 elementos

Descripción	Referencia	Emb.	Precio (€)
Blanco polar, brillo	1030 00 69	10	10,50
Marrón, brillo	1030 00 01	10	16,63
Bronce, metal	1030 90 11	10	29,07
Acero	1030 90 04	10	29,07
Rojo, brillo	1030 00 62	10	15,40

- Profundidad instalación 33,5 mm



1031 00 69

Caja montaje en superficie, 3 elementos

Descripción	Referencia	Emb.	Precio (€)
Blanco polar, brillo	1031 00 69	5	12,95
Marrón, brillo	1031 00 01	5	22,95
Bronce, metal	1031 90 11	5	44,88
Acero	1031 90 04	5	44,88
Rojo, brillo	1031 00 62	5	22,44

- Profundidad instalación 33,5 mm

Tomas de corriente



1719 00 02

Tapa para SCHUKO

Descripción	Referencia	Emb.	Precio (€)
Blanco, brillo	1719 00 02	10	5,14
Blanco polar, brillo	1719 00 69	10	5,14
Marrón, brillo	1719 00 01	10	6,88
Bronce, metal	1719 00 11	10	6,98
Acero	1719 00 14	10	7,80

- Añadir mecanismo ref. 714134
- Con protección infantil



4109 00 02

Toma SCHUKO con LED de orientación

Descripción	Referencia	Emb.	Precio (€)
Blanco, brillo	4109 00 02	10	74,01
Blanco polar, brillo	4109 00 69	10	73,97
Bronce	4109 90 11	10	81,66
Acero	4109 90 04	10	77,35

- 16A, 250 V~
- Con protección infantil
- Terminales tornillo con mordaza



4110 00 69

Toma SCHUKO con LED de control

Descripción	Referencia	Emb.	Precio (€)
Blanco, brillo	4110 00 02	10	22,53
Blanco polar, brillo	4110 00 69	10	22,53

- 16A, 250 V~
- Con protección infantil
- Terminales tornillo con mordaza
- Portaetiquetas 6 mm de alto

Teclas



1405 00 69

Tecla

Descripción	Referencia	Emb.	Precio (€)
Blanco, brillo	1405 00 02	10	2,45
Blanco polar, brillo	1405 00 69	10	2,45
Marrón, brillo	1405 00 01	10	4,08
Bronce, metal	1404 00 01	10	5,71
Acero	1404 00 04	10	5,71
Dorado, metal	1404 00 02	10	5,71



1426 00 69

Tecla con portaetiquetas

Descripción	Referencia	Emb.	Precio (€)
Blanco, brillo	1426 00 02	10	9,79
Blanco polar, brillo	1426 00 69	10	9,79
Marrón, brillo	1426 00 01	10	11,93
Bronce, metal	1436 00 01	10	16,22
Acero	1436 00 04	10	18,87
Dorado, metal	1436 00 02	10	16,22

- Etiquetas de 6 mm de alto



1487 00

Tecla con portaetiquetas grande

Descripción	Referencia	Emb.	Precio (€)
Transparente	1487 00	10	13,06

- Etiquetas 2 x 24 mm



1415 00 69

Tecla con 5 indicadores luminosos

Descripción	Referencia	Emb.	Precio (€)
Blanco, brillo	1415 00 02	10	5,61
Blanco polar, brillo	1415 00 69	10	5,61
Marrón, brillo	1415 00 01	10	6,63
Bronce, metal	1416 00 01	10	9,93
Acero	1416 00 04	10	10,30
Dorado, metal	1416 00 02	10	9,93

- Indicadores: luz, campana, puerta, neutro transparente, neutro rojo



1415 02 69

Tecla con 5 indicadores luminosos y portaetiquetas

Descripción	Referencia	Emb.	Precio (€)
Blanco, brillo	1415 02 02	10	10,91
Blanco polar, brillo	1415 02 69	10	10,91
Marrón, brillo	1415 02 01	10	11,53
Bronce, metal	1416 02 01	10	15,50
Acero	1416 02 04	10	17,14

- Etiquetas de 6 mm alto
- Indicadores: luz, campana, puerta, neutro transparente, neutro rojo



1425 00 69

Tecla con "0"

Descripción	Referencia	Emb.	Precio (€)
Blanco, brillo	1425 00 02	10	4,28
Blanco polar, brillo	1425 00 69	10	4,28
Marrón, brillo	1425 00 01	10	5,61
Bronce, metal	1424 00 01	10	13,93
Acero	1424 00 04	10	6,73
Dorado, metal	1424 00 02	10	13,93



1417 00 69

Tecla con "0" e indicador luminoso

Descripción	Referencia	Emb.	Precio (€)
Blanco, brillo	1417 00 02	10	5,61
Blanco polar, brillo	1417 00 69	10	5,61
Marrón, brillo	1417 00 01	10	6,53
Bronce, metal	1418 00 01	10	14,85
Acero	1418 00 04	10	14,18
Dorado, metal	1418 00 02	10	14,85

**Interruptor rotativo**

Descripción	Referencia	Emb.	Precio (€)
Blanco, brillo	1150 00 02	1	14,99
Blanco polar, brillo	1150 00 69	1	14,99
Marrón, brillo	1150 00 01	1	16,83
Bronce, metal	1150 10 01	1	17,14
Acero	1150 10 04	1	18,36
Dorado, metal / blanco polar	1150 10 02	1	17,14

1150 00 69

**Tecla doble**

Descripción	Referencia	Emb.	Precio (€)
Blanco, brillo	1435 00 02	10	6,63
Blanco polar, brillo	1435 00 69	10	6,63
Marrón, brillo	1435 00 01	10	8,67
Bronce, metal	1434 00 01	10	11,88
Acero	1434 00 04	10	12,14
Dorado, metal	1434 00 02	10	11,88

1435 00 69

**Tecla doble con indicador luminoso**

Descripción	Referencia	Emb.	Precio (€)
Blanco, brillo	1437 00 02	10	7,65
Blanco polar, brillo	1437 00 69	10	7,65
Marrón, brillo	1437 00 01	10	10,00

1437 00 69

**Tecla para mecanismo triple ON/OFF**

Descripción	Referencia	Emb.	Precio (€)
Blanco, brillo	1465 00 02	10	9,79
Blanco polar, brillo	1465 00 69	10	9,79
Marrón, brillo	1465 00 01	10	12,44
Bronce, metal	1465 90 11	10	27,54
Acero	1465 90 04	10	27,54

1465 00 69

**Tecla doble persiana**

Descripción	Referencia	Emb.	Precio (€)
Blanco, brillo	1435 01 02	10	7,55
Blanco polar, brillo	1435 01 69	10	7,55
Marrón, brillo	1435 01 01	10	11,53
Bronce, metal	1434 01 01	10	15,08
Acero	1434 01 04	10	15,71
Dorado, metal	1434 01 02	10	16,01

1435 01 69

Teclas con tornillos**Tecla simple**

Descripción	Referencia	Emb.	Precio (€)
Acero	1404 00 10	10	15,20

1404 00 10

**Tecla simple con indicador luminoso**

Descripción	Referencia	Emb.	Precio (€)
Acero	1414 00 10	10	16,52

1414 00 10

**Tecla doble**

Descripción	Referencia	Emb.	Precio (€)
Acero	1434 00 10	10	21,32

1434 00 10

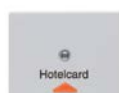
Tapas**Tapa tarjetero de hotel con indicador luminoso**

Descripción	Referencia	Emb.	Precio (€)
Blanco, brillo	1641 00 02	10	10,20
Blanco polar, brillo	1641 00 69	10	10,20
Marrón, brillo	1641 00 01	10	11,22
Bronce, metal	1641 90 11	10	27,85
Acero	1641 90 04	10	27,85

1641 00 69

• Mecanismo ref.: 5051 02, 5051 03, 5052 01, 5056 01

**Tapa interruptor / pulsador tirador**

Descripción	Referencia	Emb.	Precio (€)
Blanco, brillo	1147 00 02	10	7,45
Blanco polar, brillo	1147 00 69	10	7,45
Marrón, brillo	1147 00 01	10	9,59
Bronce, metal	1147 90 11	10	17,44
Acero	1147 90 04	10	17,44

1147 00 69

**Tapa para interruptor 3 posiciones con mando rotativo**

Descripción	Referencia	Emb.	Precio (€)
Sin posición 0			
Blanco, brillo	1088 00 02	1	11,93
Blanco polar	1088 00 69	1	11,93
Marrón, brillo	1088 00 01	1	13,26
Bronce, metal	1088 01 01	1	21,93
Acero	1088 01 04	1	21,32
Dorado, metal	1088 01 02	1	26,62
Con posición neutra			
Blanco, brillo	1087 00 02	1	11,93
Blanco polar, brillo	1087 00 69	1	11,93
Marrón, brillo	1087 00 01	1	13,26
Bronce, metal	1087 01 01	1	21,62
Acero	1087 01 04	1	20,60
Dorado, metal	1087 01 02	1	14,38

1087 00 69

**Tapa interruptor / pulsador rotativo para persianas**

Descripción	Referencia	Emb.	Precio (€)
Blanco, brillo	1077 00 02	1	11,73
Blanco polar, brillo	1077 00 69	1	11,73
Marrón, brillo	1077 00 01	1	13,57
Bronce, metal	1077 01 01	1	18,43
Acero	1077 01 04	1	16,22
Dorado, metal	1077 01 02	1	13,87

1077 00 69



Tapa con cerradura para interruptor llave de persianas

1079 00 69

Descripción	Referencia	Emb.	Precio (€)
Llave extraíble, en posición media			
Blanco, brillo	1079 00 02	1	69,46
Blanco polar, brillo	1079 00 69	1	69,46
Marrón, brillo	1079 00 01	1	79,87
Bronce, metal	1079 03 01	1	84,15
Acero	1079 03 04	1	91,39
Dorado, metal	1079 03 02	1	81,40
Llave extraíble, en las 3 posiciones			
Blanco, brillo	1079 01 02	1	69,46
Blanco polar, brillo	1079 01 69	1	69,46
Marrón, brillo	1079 01 01	1	79,87
Bronce, metal	1079 04 01	1	84,15
Acero	1079 04 04	1	91,39
Dorado, metal	1079 04 02	1	84,76

- Función bloqueo presión



1079 02 69

Tapa con cerradura para interruptor llave de persianas

Descripción	Referencia	Emb.	Precio (€)
Blanco, brillo	1079 02 02	1	69,46
Blanco polar, brillo	1079 02 69	1	69,46
Marrón, brillo	1079 02 01	1	79,87
Bronce, metal	1079 05 01	1	84,15
Acero	1079 05 04	1	91,39
Dorado, metal	1079 05 02	1	84,76

- Función sólo pulsador
- Llave extraíble en posición media



1504 00 79

Tapa para interruptor / pulsador llave para persianas

Descripción	Referencia	Emb.	Precio (€)
Blanco, brillo	1504 00 12	10	16,63
Blanco polar, brillo	1504 00 79	10	16,63
Marrón, brillo	1504 00 11	10	19,79
Bronce, metal	1504 90 21	10	24,68
Acero	1504 90 14	10	24,68

- Con símbolo



1505 00 79

Blanco, brillo	1505 00 12	10	17,75
Blanco polar, brillo	1505 00 79	10	17,75
Marrón, brillo	1505 00 11	10	19,69
Bronce, metal	1505 90 21	10	24,68
Acero	1505 90 14	10	24,99

- Sin símbolo

Tapas ciegas



1045 00 69

Tapa ciega con tapa central

Descripción	Referencia	Emb.	Precio (€)
Blanco, brillo	1045 00 02	20	9,79
Blanco polar, brillo	1045 00 69	20	9,79
Marrón, brillo	1045 00 01	20	15,10
Bronce, metal	1044 00 01	20	18,46
Acero	1044 00 04	20	17,75
Dorado, metal	1044 00 02	20	16,93

- Sin garras



67 1045 00 69

Descripción	Referencia	Emb.	Precio (€)
Blanco, brillo	67 1045 00 02	10	10,10
Blanco polar	67 1045 00 69	10	10,10
Marrón, brillo	67 1045 00 01	10	12,65
Bronce, metal	67 1044 00 01	10	14,99
Acero	67 1044 00 04	10	17,65

- Con base y garras



1045 01 69

Tapa ciega atornillada

Descripción	Referencia	Emb.	Precio (€)
Blanco, brillo	1045 01 02	20	13,86
Blanco polar, brillo	1045 01 69	20	13,36
Marrón, brillo	1045 01 01	20	16,32

Señalización



1165 01 04

Tapa central para piloto / pulsador, lámpara E10

Descripción	Referencia	Emb.	Precio (€)
Bronce, metal	1165 01 01	1	8,16
Acero	1165 01 04	1	8,06
Dorado, metal	1165 01 02	1	8,75



1165 00 69

Tapa central c/portaeti. piloto/pulsador, lámpara E10

Descripción	Referencia	Emb.	Precio (€)
Blanco, brillo	1165 00 02	1	5,92
Blanco polar, brillo	1165 00 69	1	5,92
Marrón, brillo	1165 00 01	1	6,35



1247 00 04

Tapa para pulsador y lámpara E10

Descripción	Referencia	Emb.	Precio (€)
Transparente	1247 00 04	10	24,67



1167 00 69

Tapa central para piloto, lámpara E14

Descripción	Referencia	Emb.	Precio (€)
Blanco, brillo	1167 00 02	10	6,53
Blanco polar, brillo	1167 00 69	10	6,53
Marrón, brillo	1167 00 01	10	9,18
Bronce, metal	1167 90 11	10	12,85
Acero	1167 90 04	10	12,85

Temporizadores



1634 00 69

Tapa con mando rotativo para temporizador mecánico

Descripción	Referencia	Emb.	Precio (€)
Máximo 15 minutos			
Blanco, brillo	1634 00 02	1	24,40
Blanco polar, brillo	1634 00 69	1	24,40
Marrón, brillo	1634 00 01	1	19,89
Bronce, metal	1634 01 01	1	40,90
Acero	1634 01 04	1	47,23
Dorado, metal	1634 01 02	1	40,70

Máximo 120 minutos			
Blanco, brillo	1635 00 02	1	17,44
Blanco polar, brillo	1635 00 69	1	17,44
Marrón, brillo	1635 00 01	1	19,89
Bronce, metal	1635 01 01	1	40,90
Acero	1635 01 04	1	47,23
Dorado, metal	1635 01 02	1	40,70



1735 00 02

Temporizador sencillo con pantalla

Descripción	Referencia	Emb.	Precio (€)
Blanco, brillo	1735 00 02	1	149,75
Blanco polar, brillo	1735 00 69	1	149,75
Marrón, brillo	1735 00 01	1	159,82
Bronce, metal	1735 90 11	1	172,45
Acero	1735 90 04	1	172,45



1736 00 69

Temporizador con pantalla

Descripción	Referencia	Emb.	Precio (€)
Blanco, brillo	1736 00 02	1	228,93
Blanco polar, brillo	1736 00 69	1	228,93
Marrón, brillo	1736 00 01	1	239,00
Bronce, metal	1736 90 11	1	251,62
Acero	1736 90 04	1	251,62

- Con impresión en alemán



1738 00 69

Temporizador con pantalla y conexión de sensor

Descripción	Referencia	Emb.	Precio (€)
Blanco, brillo	1738 00 02	1	275,81
Blanco polar, brillo	1738 00 69	1	275,81
Marrón, brillo	1738 00 01	1	285,89
Bronce, metal	1738 90 11	1	297,82
Acero	1738 90 04	1	297,82

- Con impresión en alemán

Tapa regulador rotativo



1135 00 69

Tapa central c/ mando rotativo para regulador rotativo

Descripción	Referencia	Emb.	Precio (€)
Blanco, brillo	1135 00 02	10	21,51
Blanco polar, brillo	1135 00 69	10	21,51
Marrón, brillo	1135 00 01	10	25,42
Bronce, metal	1134 00 01	10	29,27
Acero	1134 00 04	10	40,19
Dorado, metal	1134 00 02	10	28,46

Tapa control velocidad



1135 00 89

Tapa central con mando para control velocidad

Descripción	Referencia	Emb.	Precio (€)
Blanco, brillo	1135 00 22	10	23,24
Blanco polar, brillo	1135 00 89	10	23,24
Marrón, brillo	1135 00 21	10	27,18
Bronce, metal	1134 00 21	10	35,82
Acero	1134 00 24	10	41,95
Dorado, metal	1134 00 22	10	35,82

Tapa regulador universal



1765 00 69

Pulsador para regulador universal

Descripción	Referencia	Emb.	Precio (€)
Blanco, brillo	1765 00 02	1	39,16
Blanco polar, brillo	1765 00 69	1	39,16
Marrón, brillo	1765 00 01	1	44,05
Bronce, metal	1765 00 11	1	48,37
Acero	1765 00 04	1	48,90
Dorado, metal	1765 00 12	1	48,37

Termostatos



2030 00 69

Termostato

Descripción	Referencia	Emb.	Precio (€)
Blanco, brillo	2030 00 02	1	90,78
Blanco polar, brillo	2030 00 69	1	90,78
Marrón, brillo	2030 00 01	1	95,88
Bronce, metal	2030 90 11	1	100,98
Acero	2030 90 04	1	104,04



2026 00 69

Termostato con conmutador

Descripción	Referencia	Emb.	Precio (€)
Blanco, brillo	2026 00 02	1	88,74
Blanco polar, brillo	2026 00 69	1	88,74
Marrón, brillo	2026 00 01	1	95,88
Bronce, metal	2026 90 11	1	100,98
Acero	2026 90 04	1	104,04



2034 00 69

Termostato de suelo radiante

Descripción	Referencia	Emb.	Precio (€)
Blanco, brillo	2034 00 02	1	288,11
Blanco polar, brillo	2034 00 69	1	288,11
Marrón, brillo	2034 00 01	1	293,45
Bronce, metal	2034 90 11	1	301,56
Acero	2034 90 04	1	301,56



7594 04 09

Tapa sensor

Descripción	Referencia	Emb.	Precio (€)
Blanco, brillo	7594 04 02	1	3,59
Blanco polar, brillo	7594 04 09	1	3,59
Bronce, metal	7594 04 04	1	13,90
Acero	7594 04 03	1	13,90
Blanco polar, mate	7594 04 89	1	3,59
Antracita	7594 04 85	1	9,22
Aluminio	7594 04 83	1	11,10

- Utilizar sólo con marcos intermedios de la serie correspondiente
- Familia 96

Entretenimiento



2880 00 69

Radio

Descripción	Referencia	Emb.	Precio (€)
Blanco polar, brillo	2880 00 69	1	299,71
Acero	2880 00 04	1	306,85

- Incluye un altavoz



2882 00 69

Altavoz

Descripción	Referencia	Emb.	Precio (€)
Blanco polar, brillo	2882 00 69	1	58,32
Acero	2882 00 04	1	61,84

TV / Audio / Video



33 1532 00 69

Toma 3 x Cinch / S-Video

Descripción	Referencia	Emb.	Precio (€)
Blanco, brillo	33 1532 00 02	10	129,85
Blanco polar, brillo	33 1532 00 69	10	129,85
Bronce, metal	33 1532 90 11	10	144,98
Acero	33 1532 90 04	10	147,70



33 1540 00 69

Toma VGA

Descripción	Referencia	Emb.	Precio (€)
Blanco, brillo	33 1540 00 02	10	65,89
Blanco polar, brillo	33 1540 00 69	10	65,89
Bronce, metal	33 1540 90 11	10	76,54
Acero	33 1540 90 04	10	79,29



33 1541 00 69

Toma VGA con terminales a tornillo y mordaza

Descripción	Referencia	Emb.	Precio (€)
Blanco, brillo	33 1541 00 02	10	65,89
Blanco polar, brillo	33 1541 00 69	10	65,89
Bronce, metal	33 1541 90 11	10	76,54
Acero	33 1541 90 04	10	79,29



33 1539 00 69

Toma USB / audio 3,5 mm

Descripción	Referencia	Emb.	Precio (€)
Blanco, brillo	33 1539 00 02	10	86,00
Blanco polar, brillo	33 1539 00 69	10	86,00
Bronce, metal	33 1539 90 11	10	98,05
Acero	33 1539 90 04	10	100,77



33 1542 00 69

Toma alta definición

Descripción	Referencia	Emb.	Precio (€)
Blanco, brillo	33 1542 00 02	1	148,10
Blanco polar, brillo	33 1542 00 69	1	148,10
Bronce, metal	33 1542 90 11	1	164,52
Acero	33 1542 90 04	1	167,23



33 1543 00 69

Toma alta definición con conexión 90°

Descripción	Referencia	Emb.	Precio (€)
Blanco, brillo	33 1543 00 02	10	148,10
Blanco polar, brillo	33 1543 00 69	10	148,10
Bronce, metal	33 1543 90 11	10	164,52
Acero	33 1543 90 04	10	167,23



1412 19 09

Tapa central para conectores redondos XLR serie D

Descripción	Referencia	Emb.	Precio (€)
Blanco, brillo	1412 02	10	7,96
Blanco polar, brillo	1412 09	10	7,96
Blanco polar, mate	1412 19 09	10	8,87
Antracita	1412 16 06	10	11,12
Aluminio	1412 14 04	10	16,32

• Utilizar sólo con marcos intermedios de la serie correspondiente



1185 00 69

Tapa central con portaetiquetas para toma altavoz y conector mini

Descripción	Referencia	Emb.	Precio (€)
Blanco, brillo	1185 00 02	10	9,59
Blanco polar, brillo	1185 00 69	10	9,59
Marrón brillo	1185 00 01	10	12,65



1184 00 04

Tapa central para toma altavoz y conector mini

Descripción	Referencia	Emb.	Precio (€)
Blanco, brillo	1184 00 01	10	14,48
Blanco polar, brillo	1184 00 04	10	14,48
Marrón, brillo	1184 00 02	10	11,63



1499 00 69

Tapa central para toma TV 1 salida

Descripción	Referencia	Emb.	Precio (€)
Blanco, brillo	1499 00 02	10	4,64
Blanco polar, brillo	1499 00 69	10	4,64
Bronce, metal	1499 01 01	10	5,42
Acero	1499 00 04	10	6,63



1201 01 79

Tapa central para toma TV 2 ó 3 salidas

Descripción	Referencia	Emb.	Precio (€)
Blanco, brillo	1201 01 12	10	4,59
Blanco polar, brillo	1201 01 79	10	4,59
Marrón, brillo	1201 01 11	10	7,34
Bronce, metal	1202 00 21	10	9,18
Acero	1202 00 04	10	10,61
Dorado, metal	1202 00 02	10	9,38



1484 09

Tapa central para toma TV 4 salidas

Descripción	Referencia	Emb.	Precio (€)
Blanco, brillo	1484 02	10	4,08
Blanco polar, brillo	1484 09	10	4,08
Marrón, brillo	1484 01	10	8,77
Bronce, metal	1484 11	10	10,61
Acero	1484 04	10	10,61
Blanco polar, mate	1484 19 09	10	3,98
Antracita	1484 16 06	10	6,63
Aluminio	1484 14 04	10	10,00

• Utilizar sólo con marcos intermedios de la serie correspondiente
 • Tomas TV de Ankaro, Astro, Axing, Delta, Schwaiger



1483 09

Tapa central para toma TV 4 salidas con tornillo

Descripción	Referencia	Emb.	Precio (€)
Blanco, brillo	1483 02	10	3,77
Blanco polar, brillo	1483 09	10	3,77
Marrón, brillo	1483 01	10	8,87
Bronce, metal	1483 11	10	10,61
Acero	1483 04	10	13,16
Blanco polar, mate	1483 19 09	10	4,08
Antracita	1483 16 06	10	6,63
Aluminio	1483 14 04	10	10,00

• Utilizar sólo con marcos intermedios de la serie correspondiente
 • Tomas TV de Hirschmann

Kit de sellado IP44



1010 00

Kit sellado para Arsys IP44

Descripción	Referencia	Emb.	Precio (€)
Kit sellado para Arsys IP44	1010 00	10	10,75



1424 10 04

Tecla

Descripción	Referencia	Emb.	Precio (€)
Acero	1424 10 04	10	12,85
Con portaetiquetas, acero	1436 10 04	10	16,32

Marcos intermedios



1140 00 69

Tapa abatible con portaetiquetas, diseño plano

Descripción	Referencia	Emb.	Precio (€)
Blanco, brillo	1140 00 02	10	11,63
Blanco polar, brillo	1140 00 69	10	11,63
Marrón, brillo	1140 00 01	10	14,28
Acero	1140 90 04	10	21,52
Bronce, metal	1140 90 11	10	21,52

- Etiquetas de 6 mm alto



1141 00 69

Tapa abatible con portaetiquetas, diseño alto

Descripción	Referencia	Emb.	Precio (€)
Blanco, brillo	1141 00 02	10	13,57
Blanco polar, brillo	1141 00 69	10	13,57
Marrón, brillo	1141 00 01	10	14,28
Acero	1141 90 04	10	20,71
Bronce, metal	1141 90 11	10	20,71

- Etiquetas de 6 mm alto



1108 01 69

Anillo adaptador para tapa 50 x 50 mm.

Descripción	Referencia	Emb.	Precio (€)
Blanco, brillo	1108 01 02	10	2,55
Blanco polar, brillo	1108 01 69	10	2,55
Marrón, brillo	1108 01 01	10	2,75
Bronce, metal	1108 91 11	10	9,18
Acero	1108 91 04	10	8,06



1108 00 69

Marco intermedio para tapas centrales

Descripción	Referencia	Emb.	Precio (€)
Blanco, brillo	1108 00 02	10	2,67
Blanco polar, brillo	1108 00 69	10	2,67
Marrón, brillo	1108 00 01	10	2,86
Bronce, metal	1108 90 11	10	9,28
Acero	1108 90 04	10	8,16



1905 00 69

Portaetiquetas para marcos intermedios

Descripción	Referencia	Emb.	Precio (€)
Blanco, brillo	1905 00 02	10	3,67
Blanco polar, brillo	1905 00 69	10	3,67
Acero	1905 70 04	10	6,07



1154 00 69

Marco intermedio con tapa abatible para tapa central 50 x 50 mm

Descripción	Referencia	Emb.	Precio (€)
Blanco, brillo	1154 00 02	10	8,16
Blanco polar, brillo	1154 00 69	10	8,16
Marrón, brillo	1154 00 01	10	10,30
Bronce, metal	1154 10 01	10	20,88
Acero	1154 10 04	10	16,52
Dorado, metal	1154 10 02	10	13,57



1155 00 69

Marco intermedio con tapa abatible plana y portaetiquetas

Descripción	Referencia	Emb.	Precio (€)
Blanco, brillo	1155 00 02	10	12,04
Blanco polar, brillo	1155 00 69	10	12,04
Marrón, brillo	1155 00 01	10	15,40
Bronce, metal	1155 10 01	10	21,96
Acero	1155 10 04	10	23,66
Dorado, metal	1155 10 02	10	16,52



1155 01 69

Marco intermedio con tapa abatible y portaetiquetas

Descripción	Referencia	Emb.	Precio (€)
Blanco, brillo	1155 01 02	10	12,04
Blanco polar, brillo	1155 01 69	10	12,04
Marrón, brillo	1155 01 01	10	15,40
Bronce, metal	1155 91 11	10	31,62
Acero	1155 91 04	10	31,62

Tapa salida de cables



1005 00 69

Tapa central para salida de cable

Descripción	Referencia	Emb.	Precio (€)
Blanco, brillo	1005 00 02	10	6,02
Blanco polar, brillo	1005 00 69	10	6,02
Marrón, brillo	1005 00 01	10	8,98
Bronce, metal	1004 90 11	10	12,65
Acero	1004 90 04	10	12,65

Tapas altavoz / datos / telecomunicaciones



1035 01 69

Tapa central para toma TAE y altavoz

Descripción	Referencia	Emb.	Precio (€)
Blanco, brillo	1035 01 02	10	4,90
Blanco polar, brillo	1035 01 69	10	4,90
Marrón, brillo	1035 01 01	10	9,28
Bronce, metal	1034 00 01	10	16,32
Acero	1034 00 04	10	11,83
Dorado, metal	1034 00 02	10	15,81

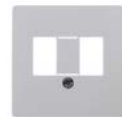

1458 09

Tapa central para toma TAE 6/6FFy 6/6NF y altavoz

Descripción	Referencia	Emb.	Precio (€)
Blanco, brillo	1458 02	10	3,77
Blanco polar, brillo	1458 09	10	3,77
Marrón, brillo	1458 01	10	8,77



1407 00 69

Tapa central para toma teléfono / red

Descripción	Referencia	Emb.	Precio (€)
Blanco, brillo	1407 00 02	10	5,30
Blanco polar, brillo	1407 00 69	10	5,30
Marrón, brillo	1407 00 01	10	7,65
Bronce, metal	1408 00 01	10	9,08
Acero	1408 00 04	10	10,71
Dorado, metal	1408 00 02	10	9,08



1468 09

Blanco, brillo	1468 02	10	2,86
Blanco polar, brillo	1468 09	10	2,86
Marrón, brillo	1468 01	10	8,77



1409 00 69

Tapa central para toma teléfono / red doble

Descripción	Referencia	Emb.	Precio (€)
Blanco, brillo	1409 00 02	10	6,63
Blanco polar, brillo	1409 00 69	10	6,63
Marrón, brillo	1409 00 01	10	9,59
Bronce, metal	1410 00 01	10	11,63
Acero	1410 00 04	10	12,95
Dorado, metal	1410 00 02	10	11,93



1469 09

Blanco, brillo	1469 02	10	4,18
Blanco polar, brillo	1469 09	10	4,18
Marrón, brillo	1469 01	10	8,77

- Utilizar sólo con marcos intermedios de la serie correspondiente



1427 09

Tapa central para 3 módulos MINI-COM

Descripción	Referencia	Emb.	Precio (€)
Blanco, brillo	1427 02	10	15,91
Blanco polar, brillo	1427 09	10	15,91
Blanco polar, mate	1427 19 09	10	15,91
Antracita	1427 16 06	10	17,85
Aluminio	1427 14 04	10	20,91

- Utilizar sólo con marcos intermedios de la serie correspondiente



1463 09

Tap central para jacks AMP

Descripción	Referencia	Emb.	Precio (€)
Blanco, brillo	1463 02	10	17,85
Blanco polar, brillo	1463 09	10	17,85
Blanco polar, mate	1463 19 09	10	21,51
Antracita	1463 16 06	10	20,09
Aluminio	1463 14 04	10	23,26

• Utilizar sólo con marcos intermedios de la serie correspondiente



1464 09

Tap central para jacks Krone

Descripción	Referencia	Emb.	Precio (€)
Blanco, brillo	1464 02	10	17,85
Blanco polar, brillo	1464 09	10	17,85
Blanco polar, mate	1464 19 09	10	21,51
Antracita	1464 16 06	10	20,09
Aluminio	1464 14 04	10	23,26

• Utilizar sólo con marcos intermedios de la serie correspondiente



1182 00 69

Tap central con protección de suciedad y portaetiquetas doble

Descripción	Referencia	Emb.	Precio (€)
Blanco, brillo	1182 00 02	10	14,08
Blanco polar, brillo	1182 00 69	10	14,08
Marrón, brillo	1182 00 01	10	16,22
Bronce, metal	1182 90 11	10	23,97
Acero	1182 90 04	10	23,97



1494 09

Tap central para AMP-ACO

Descripción	Referencia	Emb.	Precio (€)
Blanco, brillo	1494 02	10	4,18
Blanco polar, brillo	1494 09	10	4,18
Blanco polar, mate	1494 19 09	10	4,59
Antracita	1494 16 06	10	6,63
Aluminio	1494 14 04	10	10,00

• Utilizar sólo con marcos intermedios de la serie correspondiente



1495 09

Tap central para AMP-ACO con portaetiquetas

Descripción	Referencia	Emb.	Precio (€)
Blanco, brillo	1495 02	10	6,43
Blanco polar, brillo	1495 09	10	6,43
Blanco polar, mate	1495 19 09	10	7,69
Antracita	1495 16 06	10	8,87
Aluminio	1495 14 04	10	11,93



1492 09

Tap central para acopladores de fibra óptica Simplex ST

Descripción	Referencia	Emb.	Precio (€)
Blanco, brillo	1492 02	10	16,22
Blanco polar, brillo	1492 09	10	16,22
Blanco polar, mate	1492 19 09	10	19,04

• Utilizar sólo con marcos intermedios de la serie correspondiente



1480 09

Tap central para acopladores de fibra óptica Duplex SC

Descripción	Referencia	Emb.	Precio (€)
Blanco, brillo	1480 02	10	16,73
Blanco polar, brillo	1480 09	10	16,73
Blanco polar, mate	1480 19 09	10	19,04

• Utilizar sólo con marcos intermedios de la serie correspondiente



1411 19 09

Tap central para conector 1 D-subminiatura

Descripción	Referencia	Emb.	Precio (€)
Blanco, brillo	1411 02	10	7,55
Blanco polar, brillo	1411 09	10	7,55
Blanco polar, mate	1411 19 09	10	7,65

• Utilizar sólo con marcos intermedios de la serie correspondiente



1470 19 09

Tap central para conector 2 D-subminiatura

Descripción	Referencia	Emb.	Precio (€)
Blanco, brillo	1470 02	10	15,07
Blanco polar, brillo	1470 09	10	15,07
Blanco polar, mate	1470 19 09	10	16,28

• Utilizar sólo con marcos intermedios de la serie correspondiente

Tap toma USB de carga



68 1034 70 09

Tap toma USB de carga

Descripción	Referencia	Emb.	Precio (€)
Blanco brillo	68 1035 00 02	10	4,20
Blanco polar brillo	68 1035 00 69	10	4,20
Marrón	68 1035 00 01	10	4,20
Bronce	68 1034 00 01	10	10,00
Acero	68 1034 00 04	10	10,00

Unidades de señalización y gestión



1431 09

Tap transmisión y control de dispositivo 18,8 mm

Descripción	Referencia	Emb.	Precio (€)
Blanco, brillo	1431 02	10	7,85
Blanco polar, brillo	1431 09	10	7,85
Acero	1431 04	10	16,42
Blanco polar, mate	1431 19 09	10	9,33
Antracita, mate	1431 16 06	10	11,83

• Utilizar sólo con marcos intermedios de la serie correspondiente



1070 01 04

Bronce, metal	1070 01 01	10	18,16
Acero	1070 01 04	10	20,91
Dorado, metal	1070 01 02	10	21,83

• Mecanismo ref: 4604

Tapas sistemas hospitalarios



1403 19 09

Tap toma doble equipotencial

Descripción	Referencia	Emb.	Precio (€)
Blanco, brillo	1403 02	10	7,85
Blanco polar, brillo	1403 09	10	7,85
Blanco polar, mate	1403 19 09	10	7,75
Antracita	1403 16 06	10	10,20
Aluminio	1403 14 04	10	14,69
Acero	1705 01 04	10	27,23

• Mecanismo ref.: 1061
• Utilizar sólo con marcos intermedios de la serie correspondiente



1474 09

Tap para toma 6 polos / Timbre BBH01

Descripción	Referencia	Emb.	Precio (€)
Blanco, brillo	1474 02	10	6,63
Blanco polar, brillo	1474 09	10	6,63
Blanco polar, mate	1474 19 09	10	7,24
Antracita	1474 16 06	10	8,57
Aluminio	1474 14 04	10	11,53
Acero	1474 04	10	20,60

• Utilizar sólo con marcos intermedios correspondientes para BBH01:

- 1108 00 02 - Blanco brillo
- 1108 00 69 - Blanco polar, brillo
- 1108 90 04 - Acero

Tapas para mecanismos Ackermann

Tapa terminación distribuidor datos / unidad vacía

Descripción	Referencia	Emb.	Precio (€)
Blanco, brillo	1204 00 12	10	8,26
Blanco polar, brillo	1204 00 69	10	8,26
Acero	1204 90 04	10	15,20

1204 00 69

Tapa unidad de conexión bus de datos con salida

Descripción	Referencia	Emb.	Precio (€)
Blanco, brillo	1298 00 02	10	9,49
Blanco polar, brillo	1298 00 69	10	9,49
Acero	1298 90 04	10	16,32

1298 00 69

Tapa conector enchufe y toma

Descripción	Referencia	Emb.	Precio (€)
Blanco, brillo	1305 00 02	10	22,33
Blanco polar, brillo	1305 00 69	10	22,33
Acero	1305 90 04	10	18,76

1305 00 69

Tapa 2 salidas

Descripción	Referencia	Emb.	Precio (€)
Blanco, brillo	1238 00 02	10	9,49
Blanco polar, brillo	1238 00 69	10	9,49
Acero	1238 90 04	10	16,32

1238 00 69

Tapa 2 salidas e impresión

Descripción	Referencia	Emb.	Precio (€)
Blanco, brillo	1244 00 02	10	10,71
Blanco polar, brillo	1244 00 69	10	10,71
Acero	1244 90 04	10	17,44

1244 00 69

Blanco, brillo	1242 00 02	10	10,71
Blanco polar, brillo	1242 00 69	10	10,71
Acero	1242 90 04	10	17,44

1242 00 69

Tapa con pulsador de llamada abajo rojo y salida

Descripción	Referencia	Emb.	Precio (€)
Blanco, brillo	1224 00 02	10	14,79
Blanco polar, brillo	1224 00 69	10	14,79
Acero	1224 90 04	10	23,56

1224 00 69

Tapa con pulsador de llamada arriba rojo y salida

Descripción	Referencia	Emb.	Precio (€)
Blanco, brillo	1217 00 02	10	14,69
Blanco polar, brillo	1217 00 69	10	14,69
Acero	1217 90 04	10	22,34

1217 00 69

Tapa con pulsador de llamada rojo y 2 salidas

Descripción	Referencia	Emb.	Precio (€)
Blanco, brillo	1218 00 02	10	14,79
Blanco polar, brillo	1218 00 69	10	14,79
Acero	1218 90 04	10	23,56

1218 00 69

Tapa con pulsador de llamada rojo arriba

Descripción	Referencia	Emb.	Precio (€)
Blanco, brillo	1216 00 02	10	14,28
Blanco polar, brillo	1216 00 69	10	14,28
Acero	1216 90 04	10	23,56

1216 00 69

Tapa con pulsador de llamada rojo abajo

Descripción	Referencia	Emb.	Precio (€)
Blanco, brillo	1219 00 02	10	14,79
Blanco polar, brillo	1219 00 69	10	14,79
Acero	1219 90 04	10	23,56

1219 00 69

Tapa con pulsador de apagado verde abajo

Descripción	Referencia	Emb.	Precio (€)
Blanco, brillo	1251 00 02	10	14,28
Blanco polar, brillo	1251 00 69	10	14,28
Blanco polar, mate	1251 90 04	10	23,56

1251 00 69

Tapa con pulsador de apagado amarillo abajo

Descripción	Referencia	Emb.	Precio (€)
Blanco, brillo	1252 00 02	10	14,28
Blanco polar, brillo	1252 00 69	10	14,28
Acero	1252 90 04	10	23,56

1252 00 69

Tapa con pulsador de llamada a doctor en azul

Descripción	Referencia	Emb.	Precio (€)
Blanco, brillo	1223 00 02	10	14,79
Blanco polar, brillo	1223 00 69	10	14,79
Acero	1223 90 04	10	23,56

1223 00 69

Tapa con pulsador de confirmación blanco

Descripción	Referencia	Emb.	Precio (€)
Blanco, brillo	1308 00 02	10	16,62
Blanco polar, brillo	1308 00 69	10	16,62
Acero	1308 90 04	10	27,18

1308 00 69

Tapa con pulsador rojo de llamada y verde de apagado

Descripción	Referencia	Emb.	Precio (€)
Blanco, brillo	1249 00 02	10	19,99
Blanco polar, brillo	1249 00 69	10	19,99
Acero	1249 90 04	10	29,68

1249 00 69

Tapa con pulsador verde y amarillo de apagado

Descripción	Referencia	Emb.	Precio (€)
Blanco, brillo	1253 00 02	10	20,09
Blanco polar, brillo	1253 00 69	10	20,09
Acero	1253 90 04	10	29,68

1253 00 69

Tapa con pulsador verde de presencia / blanco de confirmación

Descripción	Referencia	Emb.	Precio (€)
Blanco, brillo	1299 00 02	10	19,99
Blanco polar, brillo	1299 00 69	10	19,99
Acero	1299 90 04	10	29,68

1299 00 69

Tapa para llamada neumática con indicador

Descripción	Referencia	Emb.	Precio (€)
Blanco, brillo	1236 00 02	10	9,49
Blanco polar, brillo	1236 00 69	10	9,49
Acero	1236 90 04	10	16,32

1236 00 69

Tapa para pulsador de tirador con indicador

Descripción	Referencia	Emb.	Precio (€)
Blanco, brillo	1233 00 02	10	9,49
Blanco polar, brillo	1233 00 69	10	9,49
Acero	1233 90 04	10	16,32

1233 00 69

Tapa para sistema radio con pequeño sistema de sonido

Descripción	Referencia	Emb.	Precio (€)
Blanco, brillo	1300 00 02	10	10,40
Blanco polar, brillo	1300 00 69	10	10,40
Acero	1300 90 14	10	17,44

1300 00 69

Tapa para selector de programa de radio

Descripción	Referencia	Emb.	Precio (€)
Blanco, brillo	1301 00 02	10	10,40
Blanco polar, brillo	1301 00 69	10	10,40
Acero	1301 90 04	10	17,44

1301 00 69

Tapa para micrófono

Descripción	Referencia	Emb.	Precio (€)
Blanco, brillo	1302 00 02	1	52,44
Blanco polar, brillo	1302 00 69	1	52,44
Acero	1302 90 04	1	46,31

1302 00 69

Marcos



1313 00 07

Descripción	Referencia	Emb.	Precio (€)
1 elemento, cobre, metal	1313 00 07	10	22,87
2 elementos vertical, cobre, metal	1323 00 07	2	35,50
2 elementos horizontal, cobre, metal	1363 00 07	2	35,50
3 elementos vertical, cobre, metal	1333 00 07	2	53,67
3 elementos horizontal, cobre, metal	1373 00 07	2	53,67

Tecla



1405 00 07

Descripción	Referencia	Emb.	Precio (€)
Tecla simple, cobre, metal	1405 00 07	10	18,59
Tecla doble, cobre, metal	1434 00 07	10	25,97
Tecla doble persianas, cobre, metal	1434 01 07	10	32,18

Tomas de corriente



4135 00 07

Descripción	Referencia	Emb.	Precio (€)
Toma SCHUKO	4135 00 07	10	29,77
Toma de corriente 'francesa'	67 6874 00 07	10	29,77

- 16A, 250 V~
- Conexión tornillos
- Con protección infantil



berker R.1

berker R.1 interpreta el radio de una forma radicalmente nueva y única.

Las novedosas superficies berker R.1 son tan puras y refrescantes como su diseño: hormigón, cuero, madera, pizarra y fibra acrílica.



reddot design award
winner 2013



materialPREIS2014





berker R.3

Debido a su marco angulado y la disposición circular de las piezas centrales, berker R.3 destaca por la fuerza del contraste. Al igual que berker R.1, los diferentes modelos abarcan todas las características que se le pueden exigir actualmente a un interruptor.



product
design award
2013



reddot design award
winner 2013



Marcos



Marcos blanco polar, brillo

1011 21 89

Descripción	Referencia	Emb.	Precio (€)
1 elemento	1011 21 89	10	2,43
2 elementos	1012 21 89	2	4,01
3 elementos	1013 21 89	2	7,08
4 elementos	1014 21 89	2	9,88
5 elementos	1015 21 89	2	16,20

• Montaje vertical y horizontal



Marcos negro, brillo

1011 21 45

Descripción	Referencia	Emb.	Precio (€)
1 elemento	1011 21 45	10	4,55
2 elementos	1012 21 45	2	6,56
3 elementos	1013 21 45	10	10,56
4 elementos	1014 21 45	2	17,12
5 elementos	1015 21 45	2	23,92

• Montaje vertical y horizontal



Marcos aluminio/blanco polar

1011 21 74

Descripción	Referencia	Emb.	Precio (€)
1 elemento	1011 21 74	10	40,00
2 elementos	1012 21 74	10	70,62
3 elementos	1013 21 74	10	80,46
4 elementos	1014 21 74	2	110,05
5 elementos	1015 21 74	2	149,99

• Montaje vertical y horizontal



Marcos aluminio/negro

1011 21 84

Descripción	Referencia	Emb.	Precio (€)
1 elemento	1011 21 84	10	40,00
2 elementos	1012 21 84	10	70,62
3 elementos	1013 21 84	10	77,09
4 elementos	1014 21 84	2	105,44
5 elementos	1015 21 84	2	143,70

• Montaje vertical y horizontal



Marcos acero/blanco polar

1011 21 14

Descripción	Referencia	Emb.	Precio (€)
1 elemento	1011 21 14	10	45,00
2 elementos	1012 21 14	10	79,45
3 elementos	1013 21 14	10	132,85
4 elementos	1014 21 14	2	181,71
5 elementos	1015 21 14	2	247,66

• Montaje vertical y horizontal



Marcos acero/negro

1011 21 04

Descripción	Referencia	Emb.	Precio (€)
1 elemento	1011 21 04	10	45,00
2 elementos	1012 21 04	10	79,45
3 elementos	1013 21 04	10	132,85
4 elementos	1014 21 04	2	181,71
5 elementos	1015 21 04	2	247,66

• Montaje vertical y horizontal



Marcos cristal blanco polar

1011 21 09

Descripción	Referencia	Emb.	Precio (€)
1 elemento	1011 21 09	10	30,00
2 elementos	1012 21 09	5	52,97
3 elementos	1013 21 09	5	69,74
4 elementos	1014 21 09	1	95,39
5 elementos	1015 21 09	1	130,01

• Montaje vertical y horizontal



Marcos cristal negro

1011 21 16

Descripción	Referencia	Emb.	Precio (€)
1 elemento	1011 21 16	10	30,00
2 elementos	1012 21 16	5	52,97
3 elementos	1013 21 16	5	68,84
4 elementos	1014 21 16	1	94,16
5 elementos	1015 21 16	1	128,32

• Montaje vertical y horizontal



Marcos pizarra, blanco polar

1011 23 89

Descripción	Referencia	Emb.	Precio (€)
1 elemento	1011 23 89	1	45,78
2 elementos	1012 23 89	1	73,11
3 elementos	1013 23 89	1	105,98

• Montaje vertical y horizontal



Marcos pizarra, negro

1011 23 84

Descripción	Referencia	Emb.	Precio (€)
1 elemento	1011 23 84	1	44,93
2 elementos	1012 23 84	1	73,56
3 elementos	1013 23 84	1	105,98

• Montaje vertical y horizontal



Marcos hormigón, blanco polar

1011 23 79

Descripción	Referencia	Emb.	Precio (€)
1 elemento	1011 23 79	1	54,78
2 elementos	1012 23 79	1	98,48
3 elementos	1013 23 79	1	142,31

• Montaje vertical y horizontal



Marcos hormigón, negro

1011 23 74

Descripción	Referencia	Emb.	Precio (€)
1 elemento	1011 23 74	1	54,78
2 elementos	1012 23 74	1	98,48
3 elementos	1013 23 74	1	142,31

• Montaje vertical y horizontal



Marcos piel marrón, blanco polar

1011 23 69

Descripción	Referencia	Emb.	Precio (€)
1 elemento	1011 23 69	1	27,43
2 elementos	1012 23 69	1	48,43
3 elementos	1013 23 69	1	80,98
4 elementos	1014 23 69	1	110,76
5 elementos	1015 23 69	1	150,96

• Montaje vertical y horizontal



Marcos piel marrón, negro

1011 23 64

Descripción	Referencia	Emb.	Precio (€)
1 elemento	1011 23 64	1	27,43
2 elementos	1012 23 64	1	48,43
3 elementos	1013 23 64	1	80,98
4 elementos	1014 23 64	1	110,76
5 elementos	1015 23 64	1	150,96

• Montaje vertical y horizontal



Marcos madera, blanco polar

1011 23 59

Descripción	Referencia	Emb.	Precio (€)
1 elemento	1011 23 59	1	27,43
2 elementos	1012 23 59	1	48,43
3 elementos	1013 23 59	1	80,98
4 elementos	1014 23 59	1	110,76
5 elementos	1015 23 59	1	150,96

• Montaje vertical y horizontal



Marcos madera, negro

1011 23 54

Descripción	Referencia	Emb.	Precio (€)
1 elemento	1011 23 54	1	27,43
2 elementos	1012 23 54	1	48,43
3 elementos	1013 23 54	1	80,98
4 elementos	1014 23 54	1	110,76
5 elementos	1015 23 54	1	150,96

• Montaje vertical y horizontal



1011 23 49

Marcos acrílico rojo, blanco polar

Descripción	Referencia	Emb.	Precio (€)
1 elemento	1011 23 49	1	27,43
2 elementos	1012 23 49	1	48,43
3 elementos	1013 23 49	1	80,98
4 elementos	1014 23 49	1	110,76
5 elementos	1015 23 49	1	150,96

- Montaje vertical y horizontal



1011 23 44

Marcos acrílico rojo, negro

Descripción	Referencia	Emb.	Precio (€)
1 elemento	1011 23 44	1	27,43
2 elementos	1012 23 44	1	48,43
3 elementos	1013 23 44	1	80,98
4 elementos	1014 23 44	1	110,76
5 elementos	1015 23 44	1	150,96

- Montaje vertical y horizontal



1011 23 39

Marcos acrílico naranja, blanco polar

Descripción	Referencia	Emb.	Precio (€)
1 elemento	1011 23 39	1	27,43
2 elementos	1012 23 39	1	48,43
3 elementos	1013 23 39	1	80,98
4 elementos	1014 23 39	1	110,76
5 elementos	1015 23 39	1	150,96

- Montaje vertical y horizontal



1011 23 34

Marcos acrílico naranja, negro

Descripción	Referencia	Emb.	Precio (€)
1 elemento	1011 23 34	1	27,43
2 elementos	1012 23 34	1	48,43
3 elementos	1013 23 34	1	80,98
4 elementos	1014 23 34	1	110,76
5 elementos	1015 23 34	1	150,96

- Montaje vertical y horizontal



1011 21 79

Marco con portaetiquetas, blanco polar, brillo

Descripción	Referencia	Emb.	Precio (€)
1 elemento	1011 21 79	10	6,52
2 elementos, vertical	1012 21 69	2	9,49
2 elementos, horizontal	1012 21 79	2	9,78
3 elementos, vertical	1013 21 69	2	10,63
3 elementos, horizontal	1013 21 79	2	10,63

- Etiquetas de 6 mm. alto



1011 21 35

Marco con portaetiquetas, negro, brillo

Descripción	Referencia	Emb.	Precio (€)
1 elemento	1011 21 35	10	7,43
2 elementos, vertical	1012 21 25	2	10,70
2 elementos, horizontal	1012 21 35	2	10,70
3 elementos, vertical	1013 21 25	2	17,23
3 elementos, horizontal	1013 21 35	2	17,23

- Etiquetas de 6 mm. alto

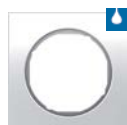

1011 22 89

Marcos blanco polar, brillo

Descripción	Referencia	Emb.	Precio (€)
1 elemento	1011 22 89	10	2,43
2 elementos	1012 22 89	2	4,01
3 elementos	1013 22 89	2	7,08
4 elementos	1014 22 89	2	9,88
5 elementos	1015 22 89	2	16,20

• Montaje vertical y horizontal



1011 22 16

Marcos cristal negro

Descripción	Referencia	Emb.	Precio (€)
1 elemento	1011 22 16	10	30,00
2 elementos	1012 22 16	5	52,97
3 elementos	1013 22 16	5	68,84
4 elementos	1014 22 16	1	94,16
5 elementos	1015 22 16	1	128,32

• Montaje vertical y horizontal



1011 22 45

Marcos negro, brillo

Descripción	Referencia	Emb.	Precio (€)
1 elemento	1011 22 45	10	4,55
2 elementos	1012 22 45	2	6,56
3 elementos	1013 22 45	10	10,56
4 elementos	1014 22 45	2	17,12
5 elementos	1015 22 45	10	23,92

• Montaje vertical y horizontal



1011 22 79

Marco con portaetiquetas, blanco polar, brillo

Descripción	Referencia	Emb.	Precio (€)
1 elemento	1011 22 79	10	6,52
2 elementos, vertical	1012 22 69	2	9,78
2 elementos, horizontal	1012 22 79	2	9,78
3 elementos, vertical	1013 22 69	2	10,63
3 elementos, horizontal	1013 22 79	2	10,63

• Etiquetas de 6 mm. alto



1011 22 74

Marcos aluminio/blanco polar

Descripción	Referencia	Emb.	Precio (€)
1 elemento	1011 22 74	10	40,00
2 elementos	1012 22 74	10	70,62
3 elementos	1013 22 74	10	80,46
4 elementos	1014 22 74	2	110,05
5 elementos	1015 22 74	2	149,99

• Montaje vertical y horizontal



1011 22 35

Marco con portaetiquetas, negro, brillo

Descripción	Referencia	Emb.	Precio (€)
1 elemento	1011 22 35	10	7,43
2 elementos, vertical	1012 22 25	2	10,70
2 elementos, horizontal	1012 22 35	2	10,70
3 elementos, vertical	1013 22 25	2	17,23
3 elementos, horizontal	1013 22 35	2	17,23

• Etiquetas de 6 mm. alto

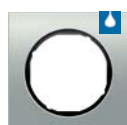

1011 22 84

Marcos aluminio/negro

Descripción	Referencia	Emb.	Precio (€)
1 elemento	1011 22 84	10	40,00
2 elementos	1012 22 84	10	70,62
3 elementos	1013 22 84	10	77,09
4 elementos	1014 22 84	2	105,44
5 elementos	1015 22 84	2	143,70

• Montaje vertical y horizontal



1011 22 14

Marcos acero/blanco polar

Descripción	Referencia	Emb.	Precio (€)
1 elemento	1011 22 14	10	45,00
2 elementos	1012 22 14	10	79,45
3 elementos	1013 22 14	10	132,85
4 elementos	1014 22 14	2	181,71
5 elementos	1015 22 14	2	247,66

• Montaje vertical y horizontal

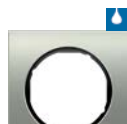

1011 22 04

Marcos acero/negro

Descripción	Referencia	Emb.	Precio (€)
1 elemento	1011 22 04	10	45,00
2 elementos	1012 22 04	10	79,45
3 elementos	1013 22 04	10	132,85
4 elementos	1014 22 04	2	181,71
5 elementos	1015 22 04	2	247,66

• Montaje vertical y horizontal



1011 22 09

Marcos cristal blanco polar

Descripción	Referencia	Emb.	Precio (€)
1 elemento	1011 22 09	10	30,00
2 elementos	1012 22 09	5	52,97
3 elementos	1013 22 09	5	69,74
4 elementos	1014 22 09	1	95,39
5 elementos	1015 22 09	1	130,01

• Montaje vertical y horizontal

Cajas para montaje en superficie R.3

1041 89 89

Caja montaje en superficie, 1 elemento

Descripción	Referencia	Emb.	Precio (€)
Blanco polar, brillo	1041 89 89	10	11,32
Negro, brillo	1041 89 35	10	10,09



1042 89 89

Caja montaje en superficie, 2 elementos

Descripción	Referencia	Emb.	Precio (€)
Blanco polar, brillo	1042 89 89	5	19,99
Negro, brillo	1042 89 35	5	17,32



1043 89 89

Caja montaje en superficie, 3 elementos

Descripción	Referencia	Emb.	Precio (€)
Blanco polar, brillo	1043 89 89	5	31,52
Negro, brillo	1043 89 35	5	27,11

Kits de sellado IP44

1010 76 00

Kit para tomas schuko y tapas

Descripción	Referencia	Emb.	Precio (€)
Transparente	1010 76 00	1	6,44



1010 77 00

Kit para tecla interruptor y pulsador

Descripción	Referencia	Emb.	Precio (€)
Transparente	1010 77 00	1	10,14



1010 78 00

NUEVO Kit para mecanismos persianas

Descripción	Referencia	Emb.	Precio (€)
Transparente	1010 78 00	1	10,00

Tomas de corriente SCHUKO



1719 20 89

Tapa para SCHUKO

Descripción	Referencia	Emb.	Precio (€)
Blanco polar, brillo	1719 20 89	10	3,72
Negro, brillo	1719 20 45	10	4,56
Rojo	1719 20 22	10	3,79

- Añadir mecanismo ref. 714134
- Con protección infantil

Tapa para SCHUKO con tapa articulada

Descripción	Referencia	Emb.	Precio (€)
Blanco polar, brillo	1720 20 89	10	16,17
Negro, brillo	1720 20 45	10	18,37

- Añadir mecanismo ref. 714134



4109 20 89

Toma de corriente SCHUKO con LED de orientación

Descripción	Referencia	Emb.	Precio (€)
Blanco polar, brillo	4109 20 89	10	85,53
Negro, brillo	4109 20 45	10	85,53

- 16A, 250 V ~
- Con protección infantil
- Terminales tornillo con mordaza



4110 20 89

Toma de corriente SCHUKO con LED de control

Descripción	Referencia	Emb.	Precio (€)
Blanco polar, brillo	4110 20 89	10	75,73
Negro, brillo	4110 20 45	10	75,73

- 16A, 250 V ~
- Con protección infantil
- Terminales tornillo con mordaza

Teclas



1620 20 89

Teclas

Descripción	Referencia	Emb.	Precio (€)
Blanco polar, brillo	1620 20 89	10	2,32
Negro, brillo	1620 20 45	10	4,98



1620 20 79

Teclas con símbolo luz

Descripción	Referencia	Emb.	Precio (€)
Blanco polar, brillo	1620 20 79	10	2,71
Negro, brillo	1620 20 35	10	5,82



1620 20 69

Teclas con símbolo campana

Descripción	Referencia	Emb.	Precio (€)
Blanco polar, brillo	1620 20 69	10	2,71
Negro, brillo	1620 20 25	10	5,82



1620 20 59

Teclas con símbolo llave

Descripción	Referencia	Emb.	Precio (€)
Blanco polar, brillo	1620 20 59	10	2,71
Negro, brillo	1620 20 15	10	5,82



1621 20 89

Teclas con indicador luminoso

Descripción	Referencia	Emb.	Precio (€)
Blanco polar, brillo	1621 20 89	10	3,75
Negro, brillo	1621 20 45	10	5,82



1621 20 79

Teclas con indicador luminoso y símbolo luz

Descripción	Referencia	Emb.	Precio (€)
Blanco polar, brillo	1621 20 79	10	5,21
Negro, brillo	1621 20 35	10	5,82



1622 20 89

Teclas con símbolo "0"

Descripción	Referencia	Emb.	Precio (€)
Blanco polar, brillo	1622 20 89	10	4,07
Negro, brillo	1622 20 45	10	5,82



1624 20 89

Teclas con símbolo "0" e indicador luminoso

Descripción	Referencia	Emb.	Precio (€)
Blanco polar, brillo	1624 20 89	10	5,21
Negro, brillo	1624 20 45	10	5,82



1623 20 89

Teclas dobles

Descripción	Referencia	Emb.	Precio (€)
Blanco polar, brillo	1623 20 89	10	3,28
Negro, brillo	1623 20 45	10	7,07



1627 20 89

Teclas dobles con indicador luminoso

Descripción	Referencia	Emb.	Precio (€)
Blanco polar, brillo	1627 20 89	10	7,01
Negro, brillo	1627 20 45	10	8,76



1625 20 89

Tecla doble persiana

Descripción	Referencia	Emb.	Precio (€)
Blanco polar, brillo	1625 20 89	10	4,08
Negro, brillo	1625 20 45	10	8,76

Teclas sin barreras

1661 20 49

Tecla simple con indicador luminoso

Descripción	Referencia	Emb.	Precio (€)
Blanco polar, brillo	1661 20 49	10	29,94



1651 20 49

Tecla simple con indicador luminoso y símbolo luz en relieve

Descripción	Referencia	Emb.	Precio (€)
Blanco polar, brillo	1651 20 49	10	22,93



1651 20 89

Tecla simple con indicador luminoso y símbolo campana en relieve

Descripción	Referencia	Emb.	Precio (€)
Blanco polar, brillo	1651 20 89	10	22,89



1651 20 69

Tecla simple con indicador luminoso y símbolo llave en relieve

Descripción	Referencia	Emb.	Precio (€)
Blanco polar, brillo	1651 20 69	10	22,89

Tapas

1146 20 89

Tapa interruptor/pulsador tirador

Descripción	Referencia	Emb.	Precio (€)
Blanco polar, brillo	1146 20 89	10	5,52
Negro, brillo	1146 20 45	10	6,00



1084 20 89

Tapa p/interruptor 3 posiciones con mando rotativo

Descripción	Referencia	Emb.	Precio (€)
Blanco polar, brillo	1084 20 89	1	18,37
Negro, brillo	1084 20 45	1	18,74



1096 20 89

Tapa p/interruptor 3 posiciones y 0 con mando rotativo

Descripción	Referencia	Emb.	Precio (€)
Blanco polar, brillo	1096 20 89	1	18,41
Negro, brillo	1096 20 45	1	18,78



1080 20 89

Tapa p/interruptor/pulsador rotativo para persianas

Descripción	Referencia	Emb.	Precio (€)
Blanco polar, brillo	1080 20 89	1	18,41
Negro, brillo	1080 20 45	1	18,78

NUEVO**Tapa para interruptor llave persianas**

1506 20 89

Descripción	Referencia	Emb.	Precio (€)
Blanco polar	1506 20 89	10	14,80
Negro	1506 20 45	10	14,80

• con símbolo

NUEVO

1507 20 89

Descripción	Referencia	Emb.	Precio (€)
Blanco polar	1507 20 89	10	6,77
Negro	1507 20 45	10	6,77

• sin símbolo

Tapa toma USB de carga

68 1033 20 89

Tapa cargador USB

Descripción	Referencia	Emb.	Precio (€)
Blanco polar, brillo	68 1033 20 89	10	4,25
Negro brillo	68 1033 20 45	10	6,85

Tapas ciegas

1009 20 89

Tapa ciega con tapa central

Descripción	Referencia	Emb.	Precio (€)
Blanco polar, brillo	1009 20 89	20	8,24
Negro, brillo	1009 20 45	20	8,78

Lámparas piloto

1124 20 89

Tapa central para pulsador y lámpara E10

Descripción	Referencia	Emb.	Precio (€)
Blanco polar, brillo	1124 20 89	10	4,41
Negro, brillo	1124 20 45	10	4,85



1198 20 89

Tapa central para lámpara E14

Descripción	Referencia	Emb.	Precio (€)
Blanco polar, brillo	1198 20 89	10	5,03
Negro, brillo	1198 20 45	10	5,15

Temporizadores

1632 20 89

Tapa c/mando rotativo para temporizador mecánico

Descripción	Referencia	Emb.	Precio (€)
Máximo 15 minutos			
Blanco polar, brillo	1632 20 89	1	18,25
Negro, brillo	1632 20 45	1	18,70

Máximo 120 minutos

Blanco polar, brillo	1633 20 89	1	18,25
Negro, brillo	1633 20 45	1	18,70

Regulador rotativo



1137 20 89

Mando rotativo para regulador rotativo

Descripción	Referencia	Emb.	Precio (€)
Blanco polar, brillo	1137 20 89	10	11,27
Negro, brillo	1137 20 45	10	11,34

Control velocidad



1137 20 79

Tapa central con mando para control velocidad

Descripción	Referencia	Emb.	Precio (€)
Blanco polar, brillo	1137 20 79	10	17,47
Negro, brillo	1137 20 35	10	17,88

Tarjetero hotel electrónico



1640 20 89

Tarjetero hotel electrónico

Descripción	Referencia	Emb.	Precio (€)
Blanco polar, brillo	1640 20 89	10	66,23
Negro, brillo	1640 20 45	10	66,43

Termostatos



2034 20 89

Termostato con contacto NA, para suelo radiante

Descripción	Referencia	Emb.	Precio (€)
Blanco polar, brillo	2034 20 89	1	151,10
Negro, brillo	2034 20 45	1	153,37



2026 20 89

Termostato con conmutador

Descripción	Referencia	Emb.	Precio (€)
Blanco polar, brillo	2026 20 89	1	75,00
Negro, brillo	2026 20 45	1	77,25



2030 20 89

Termostato con contacto NC

Descripción	Referencia	Emb.	Precio (€)
Blanco polar, brillo	2030 20 89	1	73,88
Negro, brillo	2030 20 45	1	76,15

TV / Audio / Video



33 1540 20 89

Toma VGA

Descripción	Referencia	Emb.	Precio (€)
Blanco polar, brillo	33 1540 20 89	10	57,92
Negro, brillo	33 1540 20 45	10	67,57



33 1541 20 89

Toma VGA con terminales a tornillo y mordaza

Descripción	Referencia	Emb.	Precio (€)
Blanco polar, brillo	33 1541 20 89	10	64,11
Negro, brillo	33 1541 20 45	10	63,09



33 1532 20 89

Toma 3 x Cinch/S-Video

Descripción	Referencia	Emb.	Precio (€)
Blanco polar, brillo	33 1532 20 89	10	83,91
Negro, brillo	33 1532 20 45	10	84,49



33 1542 20 89

Toma alta definición

Descripción	Referencia	Emb.	Precio (€)
Blanco polar, brillo	33 1542 20 89	10	95,72
Negro, brillo	33 1542 20 45	10	96,30



33 1543 20 89

Toma alta definición con conexión 90°

Descripción	Referencia	Emb.	Precio (€)
Blanco polar, brillo	33 1543 20 89	10	95,72
Negro, brillo	33 1543 20 45	10	96,30



33 1539 20 89

Toma USB / audio 3,5 mm

Descripción	Referencia	Emb.	Precio (€)
Blanco polar, brillo	33 1539 20 89	10	55,56
Negro, brillo	33 1539 20 45	10	56,16



1432 20 89

Tapa central para conectores 22,5 mm

Descripción	Referencia	Emb.	Precio (€)
Blanco polar, brillo	1432 20 89	10	6,48
Negro, brillo	1432 20 45	10	9,20



1196 20 89

Tapa central para toma altavoz y conector mini

Descripción	Referencia	Emb.	Precio (€)
Blanco polar, brillo	1196 20 89	10	5,30
Negro, brillo	1196 20 45	10	5,72



1203 20 89

Tapa central para toma TV 2 ó 3 salidas

Descripción	Referencia	Emb.	Precio (€)
Blanco polar, brillo	1203 20 89	10	5,20
Negro, brillo	1203 20 45	10	5,62



1484 20 89

Tapa central para toma TV 4 salidas

Descripción	Referencia	Emb.	Precio (€)
Blanco polar, brillo	1484 20 89	10	5,20
Negro, brillo	1484 20 45	10	5,62

Tomas de datos y telecomunicaciones



Tapa salida de cables

Descripción	Referencia	Emb.	Precio (€)
Blanco polar, brillo	1019 20 89	10	5,20
Negro, brillo	1019 20 45	10	5,62



Tapa central para toma TAE y altavoz

Descripción	Referencia	Emb.	Precio (€)
Blanco polar, brillo	1038 20 89	10	5,20
Negro, brillo	1038 20 45	10	5,62

1038 20 89



Tapa central para toma teléfono / red

Descripción	Referencia	Emb.	Precio (€)
Blanco polar, brillo	1407 20 89	10	5,20
Negro, brillo	1407 20 45	10	5,62

1407 20 89



Tapa central para toma teléfono / red doble

Descripción	Referencia	Emb.	Precio (€)
Blanco polar, brillo	1409 20 89	10	5,20
Negro, brillo	1409 20 45	10	5,62

1409 20 89



Tapa central con protección de suciedad y portaetiquetas

Descripción	Referencia	Emb.	Precio (€)
Blanco polar, brillo	1170 20 89	10	11,89
Negro, brillo	1170 20 45	10	12,18

1170 20 89



Tapa central con protección de suciedad y portaetiquetas doble

Descripción	Referencia	Emb.	Precio (€)
Blanco polar, brillo	1181 20 89	10	14,62
Negro, brillo	1181 20 45	10	14,99

1181 20 89



Maleta promocional

Maleta muestras Berker

Descripción	Referencia	Emb.	Precio (€)
Maleta muestras 30 acabados	EXP0053C	1	350,00

- Composición:
- 20 marcos
- 11 teclas/tapa
- 2 mecanismos



Serie R.classic

Gracias a sus agradables formas redondeadas, las cuatro variantes de material de alta calidad y el interruptor giratorio, los interruptores de la Serie R.classic le harán sentir algo inesperado: entusiasmo.



reddot design award
winner 2013





Serie 1930

Berker y Bauhaus están unidas por un gusto común por las formas puras y la más directa funcionalidad. Cualidades que siguen apreciando constructores y proyectistas de hoy. Así, la Serie 1930 inspirada en la escuela Bauhaus no sólo se asocia a diseños clásicos sino también a las tendencias más actuales.





Serie 1930

Porzellan made by Rosenthal

La serie Berker 1930, fabricada en verdadera porcelana Rosenthal, constituye un homenaje a la destreza del trabajo manual, la perfección en las formas y la suavidad de materiales.



Rosenthal



DESIGN PLUS





Serie Glas

Sencillez. Belleza real en lugar de belleza aparente. Elegancia creativa como resultado de un objetivo funcional: la serie Glas, inspirada en la arquitectura de la escuela Bauhaus, encontrará la máxima expresión de todas estas características.



Marcos



1011 20 89

Marco blanco polar, brillo

Descripción	Referencia	Emb.	Precio (€)
1 elemento	1011 20 89	10	5,45
2 elementos	1012 20 89	2	15,42
3 elementos	1013 20 89	2	23,60



1011 20 45

Marco negro, brillo

Descripción	Referencia	Emb.	Precio (€)
1 elemento	1011 20 45	10	5,45
2 elementos	1012 20 45	2	15,42
3 elementos	1013 20 45	2	23,60



1011 20 74

Marco aluminio / blanco polar

Descripción	Referencia	Emb.	Precio (€)
1 elemento	1011 20 74	10	35,00
2 elementos	1012 20 74	10	59,40
3 elementos	1013 20 74	10	86,17



1011 20 84

Marco aluminio / negro

Descripción	Referencia	Emb.	Precio (€)
1 elemento	1011 20 84	10	35,00
2 elementos	1012 20 84	10	59,40
3 elementos	1013 20 84	10	86,17



1011 20 14

Marco acero / blanco polar

Descripción	Referencia	Emb.	Precio (€)
1 elemento	1011 20 14	10	45,00
2 elementos	1012 20 14	10	109,51
3 elementos	1013 20 14	10	158,85



1011 20 04

Marco acero / negro

Descripción	Referencia	Emb.	Precio (€)
1 elemento	1011 20 04	10	45,00
2 elementos	1012 20 04	10	109,51
3 elementos	1013 20 04	10	158,85



1011 20 09

Marco cristal blanco polar

Descripción	Referencia	Emb.	Precio (€)
1 elemento	1011 20 09	10	30,00
2 elementos	1012 20 09	5	59,40
3 elementos	1013 20 09	5	86,17



1011 20 16

Marco cristal negro

Descripción	Referencia	Emb.	Precio (€)
1 elemento	1011 20 16	10	30,00
2 elementos	1012 20 16	5	59,40
3 elementos	1013 20 16	5	86,17

Tomas SCHUKO



4755 20 89

Toma SCHUKO

Descripción	Referencia	Emb.	Precio (€)
Blanco polar, brillo	4755 20 89	10	16,11
Negro, brillo	4755 20 45	10	16,11

- Con protección infantil
- Terminales con conexión rápida



4109 20 89

Toma SCHUKO con LED de orientación

Descripción	Referencia	Emb.	Precio (€)
Blanco polar, brillo	4109 20 89	10	85,53
Negro, brillo	4109 20 45	10	85,53

- Con protección infantil
- Terminales tornillo con mordaza

Tapas y mandos



1001 20 89

Tapa central con mando, plástico

Descripción	Referencia	Emb.	Precio (€)
Blanco polar, brillo	1001 20 89	1	16,54
Negro, brillo	1001 20 45	1	16,54
Aluminio / Blanco polar	1001 20 74	1	45,00
Aluminio / Negro	1001 20 84	1	45,00
Acero / Blanco polar	1001 20 14	1	55,00
Acero / Negro	1001 20 04	1	55,00
Cristal / Blanco polar	1001 20 83	1	33,85
Cristal / Negro	1001 20 55	1	33,85

• No puede instalarse con marcos

Reguladores rotativos



2834 20 89

Regulador rotativo universal con mando

Descripción	Referencia	Emb.	Precio (€)
Blanco polar, brillo	2834 20 89	1	156,64
Negro, brillo	2834 20 45	1	156,64



2835 20 89

Regulador rotativo universal con mando - extensión

Descripción	Referencia	Emb.	Precio (€)
Blanco polar, brillo	2835 20 89	1	79,09
Negro, brillo	2835 20 45	1	79,09

Interruptor persianas



3811 20 89

Interruptor rotativo para persianas

Descripción	Referencia	Emb.	Precio (€)
Blanco polar, brillo, 1 polo	3811 20 89	1	62,56
Negro, brillo, 1 polo	3811 20 45	1	64,68
Blanco polar, brillo, 2 polos	3812 20 89	1	70,01
Negro, brillo, 2 polos	3812 20 45	1	72,13

Accesorios

Descripción	Referencia	Emb.	Precio (€)
Conversión a pulsador rotativo	1861 01	10	2,30

Datos / Telecomunicaciones



1038 20 89

Tapa TAE

Descripción	Referencia	Emb.	Precio (€)
Blanco polar, brillo	1038 20 89	10	5,20
Negro, brillo	1038 20 45	10	5,62



1407 20 89

Tapa FCC

Descripción	Referencia	Emb.	Precio (€)
Blanco polar, brillo	1407 20 89	10	5,20
Negro, brillo	1407 20 45	10	5,62



1409 20 89

Tapa FCC doble

Descripción	Referencia	Emb.	Precio (€)
Blanco polar, brillo	1409 20 89	10	5,20
Negro, brillo	1409 20 45	10	5,62

TV / Audio / Video



1203 20 89

Tapa TV con 2 ó 3 elementos

Descripción	Referencia	Emb.	Precio (€)
Blanco polar, brillo	1203 20 89	10	5,20
Negro, brillo	1203 20 45	10	5,62



1484 20 89

Tapa TV con 4 elementos

Descripción	Referencia	Emb.	Precio (€)
Blanco polar, brillo	1484 20 89	10	5,20
Negro, brillo	1484 20 45	10	5,62



1196 20 79

Tapa conector mini con bastidor

Descripción	Referencia	Emb.	Precio (€)
Blanco polar, brillo	1196 20 79	10	18,57
Negro, brillo	1196 20 35	10	18,57

Toma USB 230V



2600 20 89

Toma USB 230V

Descripción	Referencia	Emb.	Precio (€)
Blanco polar, brillo	2600 20 89	1	57,47
Negro, brillo	2600 20 45	1	57,47

• Con tapa incluida

Tapa ciega



1009 20 79

Tapa ciega

Descripción	Referencia	Emb.	Precio (€)
Blanco polar, brillo	1009 20 79	20	17,55
Negro, brillo	1009 20 35	20	17,55

Tapa salida cable



1019 20 89

Tapa salida cable

Descripción	Referencia	Emb.	Precio (€)
Blanco polar, brillo	1019 20 89	20	5,20
Negro, brillo	1019 20 45	20	5,62

Marcos



Marco 1 elemento

Descripción	Referencia	Emb.	Precio (€)
Blanco polar, brillo	1381 09	10	3,47
Negro, brillo	1381 01	10	3,47

1381 09

- Montaje individual
- Para combinaciones, utilizar el accesorio ref. 1887



Marco central

Descripción	Referencia	Emb.	Precio (€)
Blanco polar, brillo	1381 59	10	16,12
Negro, brillo	1381 51	10	16,12

1381 59

- Montaje en combinación



Marco final

Descripción	Referencia	Emb.	Precio (€)
Blanco polar, brillo	1381 49	10	13,77
Negro, brillo	1381 41	10	13,77

1381 49

- Montaje en combinación



Marcos 2 elementos

Descripción	Referencia	Emb.	Precio (€)
Blanco polar, brillo	1381 29	2	9,79
Negro, brillo	1381 21	2	9,79

1381 29

- Montaje vertical y horizontal



Marcos 3 elementos

Descripción	Referencia	Emb.	Precio (€)
Blanco polar, brillo	1381 39	2	14,79
Negro, brillo	1381 31	2	14,79

1381 39

- Montaje vertical y horizontal

Caja para montaje en superficie



1001 09

Descripción	Referencia	Emb.	Precio (€)
Blanco polar, brillo	1001 09	10	24,38
Negro, brillo	1001 01	10	24,38

Accesorios



1331 19

Accesorios para caja de montaje en superficie

Descripción	Referencia	Emb.	Precio (€)
Blanco polar, brillo	1331 19	10	13,24
Negro, brillo	1331 11	10	13,24



1823 09

Conectores de combinación

Descripción	Referencia	Emb.	Precio (€)
Blanco polar, brillo	1823 09	10	2,96
Negro, brillo	1823 05	10	2,96



1813 09

Entradas de cable y conductos

Descripción	Referencia	Emb.	Precio (€)
Blanco polar	1813 09	10	1,84
Negro	1813 05	10	1,84
Blanco	1813	10	1,28



1817 09

Entradas de tubo

Descripción	Referencia	Emb.	Precio (€)
Blanco polar	1817 09	10	3,57
Negro	1817 05	10	3,57

Marco



1381 69

Marco 1 elemento, porcelana

Descripción	Referencia	Emb.	Precio (€)
Blanco polar, brillo	1381 69	1	38,45
Negro, brillo	1381 65	1	38,45

Placa



1647 69

Placa central con interruptor rotativo

Descripción	Referencia	Emb.	Precio (€)
Blanco polar, brillo	1647 69	1	35,90
Negro, brillo	1647 65	1	62,88

Tapas

Tapas para pulsador/interruptor rotativo

Descripción	Referencia	Emb.	Precio (€)
Tapa, cristal	1090	10	23,46
Tapa cristal, blanco polar	1090 09	10	23,46

1090

Tapa final, cristal	1094	10	26,62
Tapa final, cristal, blanco polar	1094 09	10	26,62

1094

Tapa intermedia, cristal	1095	10	30,91
Tapa intermedia, cristal, blanco polar	1095 09	10	30,91

1095

Marcos

Marcos cristal transparente

Descripción	Referencia	Emb.	Precio (€)
1 elemento, cristal	1091	10	28,05
1 elemento, cristal, blanco polar	1091 09	10	28,05

1091

1 elemento intermedio, cristal	1093 00	10	35,80
1 elem. intermedio, cristal, blanco polar	1093 09	10	35,80

1093

1 elemento final, cristal	1092 00	10	33,05
1 elemento final, cristal, blanco polar	1092 19	10	33,05

1092

2 elementos, cristal	1102	2	50,59
2 elementos, cristal, blanco polar	1102 09	2	50,59

1102

Series berker

Ejemplo:

El marco doble para esta composición serían las siguientes referencias: 2 uds. de ref. 1092 00



Mecanismos rotativos

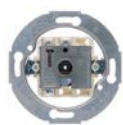

3876 00

Interruptores

Descripción	Referencia	Emb.	Precio (€)
Conmutador	3876 00	1	15,30
Cruzamiento	3877 00	1	29,99
Doble interruptor	3875 00	1	18,77
Interruptor bipolar on/off	3893 00	1	77,93

- 10 AX
- Terminales con tornillos



3846 00

Pulsadores

Descripción	Referencia	Emb.	Precio (€)
Contacto conmutador	3846 00	1	19,89
De grupo	3838 00	1	24,68

- 10 A, 250 V~
- Terminales con tornillos

Tapas y mandos



1647

Tapa central con mando plástico

Descripción	Referencia	Emb.	Precio (€)
Blanco polar, brillo	1647	1	10,20
Negro, brillo	1647 01	1	10,20

Mando



1812

Descripción	Referencia	Emb.	Precio (€)
Dorado	1812	1	33,66
Cromado	1812 01	1	39,17

Interruptor persianas



3811

Interruptor rotativo para persianas

Descripción	Referencia	Emb.	Precio (€)
Blanco polar, brillo, 1 polo	3811	1	31,82
Negro, brillo, 1 polo	3811 01	1	31,82
Blanco polar, brillo, 2 polos	3812	1	36,82
Negro, brillo, 2 polos	3812 01	1	36,82

Accesorios

Descripción	Referencia	Emb.	Precio (€)
Conversión a pulsador rotativo	1861	10	2,86

Lámparas piloto



5104

Pulsador con lámpara piloto

Descripción	Referencia	Emb.	Precio (€)
Blanco polar, brillo, contacto NO	5104	1	21,52
Negro, brillo, contacto NO	5104 01	1	21,52



1225

Accesorios, mando para pulsador y piloto E10

Descripción	Referencia	Emb.	Precio (€)
Blanco polar, brillo	1225	10	7,75
Negro, brillo	1225 01	10	7,75
Símbolo luz, blanco polar, brillo	1226	10	17,14
Símbolo campana, blanco polar, brillo	1227	10	16,63
Rojo, transparente	1229	10	17,34
Transparente	1229 02	10	17,34



1221

Accesorios, tapa

Descripción	Referencia	Emb.	Precio (€)
Transparente	1221	10	15,50
Rojo	1222	10	17,03

Reguladores rotativos



2834 10

Regulador rotativo universal con mando

Descripción	Referencia	Emb.	Precio (€)
Blanco polar, brillo	2834 10	1	298,68
Negro, brillo	2834 11	1	298,68



2835 10

Regulador rotativo universal con mando - extensión

Descripción	Referencia	Emb.	Precio (€)
Blanco polar, brillo	2835 10	1	150,82
Negro, brillo	2835 11	1	150,82

Tomas de corriente



4755

Toma SCHUKO

Descripción	Referencia	Emb.	Precio (€)
Blanco polar, brillo	4755	10	26,83
Negro, brillo	4755 01	10	26,83

- Terminales con conexión rápida
- Protección infantil



67 6879

Toma de corriente sistema francés

Descripción	Referencia	Emb.	Precio (€)
Blanco polar, brillo	67 6879	10	12,95
Negro, brillo	67 6879 01	10	12,95

- Sin protección infantil
- Conexión tornillos

Tapa ciega



1009 20

Descripción	Referencia	Emb.	Precio (€)
Blanco polar, brillo, sin garras	1009 20	20	27,95
Negro, brillo, sin garras	1009 21	20	27,95
Blanco polar, brillo, con base y garras	67 1009 20	10	27,85
Negro, brillo, con base y garras	67 1009 21	10	27,85

TV / Audio / Video

Tapa conector mini con bastidor



4508 20

Descripción	Referencia	Emb.	Precio (€)
Blanco polar, brillo	4508 20	10	32,64
Negro, brillo	4508 21	10	32,64

Tapa conector 2 elementos



1039 20

Descripción	Referencia	Emb.	Precio (€)
Blanco polar, brillo	1039 20	10	6,22
Negro, brillo	1039 21	10	6,22

Tapa conector 3 elementos



1064 20

Descripción	Referencia	Emb.	Precio (€)
Blanco polar, brillo	1064 20	10	20,50
Negro, brillo	1064 21	10	20,50

Datos / Telecomunicaciones

Tapa salida cable



1037

Descripción	Referencia	Emb.	Precio (€)
Blanco polar, brillo	1037	10	9,49
Negro, brillo	1037 01	10	9,49

Tapa TAE



1040

Descripción	Referencia	Emb.	Precio (€)
Blanco polar, brillo	1040	10	16,63
Negro, brillo	1040 01	10	16,63

Tapa FCC



1407

Descripción	Referencia	Emb.	Precio (€)
Blanco polar, brillo	1407	10	13,26
Negro, brillo	1407 01	10	13,26

Tapa FCC doble



1409

Descripción	Referencia	Emb.	Precio (€)
Blanco polar, brillo	1409	10	20,50
Negro, brillo	1409 01	10	20,50

Accesorios



1887

Separador

Descripción	Referencia	Emb.	Precio (€)
Rojo	1887	100	0,89

Series técnicas: industriales y estancas Integro y cubyko IP55

La gama industrial ofrece el sistema Integro de diseño ultracompacto, instalación rápida sin herramientas especiales e integración de sistemas de comunicación. Adecuada para caravanas, instalaciones en barco, construcción naval y laboratorios.

La gama de series de mecanismos estanco cubyko IP55 se distingue por su premiado y refinado diseño que se adapta a todos los entornos y resiste todas las estaciones. La flexibilidad de su gama, su montaje rápido e intuitivo, su estanqueidad perfecta IP55 y su visibilidad notable gracias al anillo luminoso de LEDs, son 4 buenas razones por las que escoger cubyko.



Series técnicas

pág.

berker Integro	150
cubyko IP55	159



berker Integro

Con su diseño ultracompacto y con una profundidad de instalación mínima, berker Integro es adecuado para espacios pequeños y para uso en caravanas o construcción de muebles así como para responder a las exigencias especiales de instalación en barcos, construcciones navales y laboratorios.

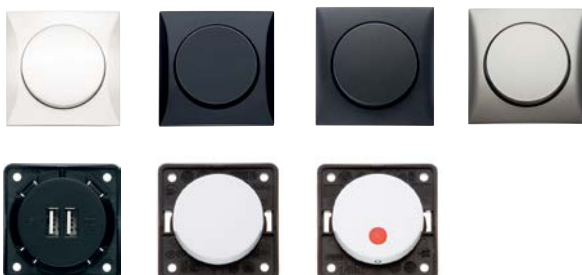

Marcos

1 elemento



9 1827 25 09

Descripción	Referencia	Emb.	Precio (€)
Marrón, mate	9 1827 25 01	10	0,95
Antracita, mate	9 1827 25 05	10	0,95
Gris, brillo	9 1827 25 07	10	0,95
Blanco polar, brillo	9 1827 25 09	10	0,95
Negro, brillo	9 1827 25 10	10	0,95
Cromo, mate	9 1827 25 58	10	10,65
Acero	9 1827 25 24	10	10,65

2 elementos



9 1826 25 19

Descripción	Referencia	Emb.	Precio (€)
Marrón, mate	9 1826 25 11	2	2,28
Antracita, mate	9 1826 25 15	2	2,28
Gris, brillo	9 1826 25 07	2	2,28
Blanco polar, brillo	9 1826 25 19	2	2,28
Negro, brillo	9 1826 25 10	2	2,28
Cromo, mate	9 1826 25 58	2	13,57
Acero	9 1826 25 24	2	13,57

3 elementos



9 1819 25 19

Descripción	Referencia	Emb.	Precio (€)
Marrón, mate	9 1819 25 11	2	3,38
Antracita, mate	9 1819 25 15	2	3,38
Gris, brillo	9 1819 25 07	2	3,38
Blanco polar, brillo	9 1819 25 19	2	3,38
Negro, brillo	9 1819 25 10	2	3,38
Cromo, mate	9 1819 25 68	2	18,10
Acero	9 1819 25 24	2	18,10

1 elemento con portaetiquetas



9 1803 25 09

Descripción	Referencia	Emb.	Precio (€)
Antracita, mate	9 1803 25 05	10	5,21
Gris, brillo	9 1803 25 07	10	5,21
Blanco polar, brillo	9 1803 25 09	10	5,21
Cromo, mate	9 1803 25 68	10	18,20

1 elemento con impresión IP44



9 1827 25 99

Descripción	Referencia	Emb.	Precio (€)
Marrón, mate	9 1827 25 91	10	1,05
Antracita, mate	9 1827 25 95	10	1,05
Gris, brillo	9 1827 25 97	10	1,05
Blanco polar, brillo	9 1827 25 99	10	1,05
Cromo, mate	9 1827 25 68	10	12,65



9 1828 25 09

1 elemento con tapa

Descripción	Referencia	Emb.	Precio (€)
Marrón, mate	9 1828 25 01	10	3,37
Antracita, mate	9 1828 25 05	10	3,37
Gris, brillo	9 1828 25 07	10	3,37
Blanco polar, brillo	9 1828 25 09	10	3,37
Negro, brillo	9 1828 25 10	10	3,37
Cromo, mate	9 1828 25 78	10	14,93
Acero	9 1828 25 24	10	14,93
Rojo	9 1828 25 76	10	4,12



9 1988 25 02

1 elemento con tapa y portaetiquetas

Descripción	Referencia	Emb.	Precio (€)
Antracita, mate	9 1988 25 05	10	10,82
Gris, brillo	9 1988 25 06	10	10,82
Blanco polar, brillo	9 1988 25 02	10	10,82



9 1828 25 99

1 elemento con tapa e impresión IP44

Descripción	Referencia	Emb.	Precio (€)
Marrón, mate	9 1828 25 91	10	4,42
Antracita, mate	9 1828 25 95	10	4,42
Gris, brillo	9 1828 25 97	10	4,42
Blanco polar, brillo	9 1828 25 99	10	4,42
Cromo, mate	9 1828 25 68	10	15,47



9 4516 25 09

Tapa ciega

Descripción	Referencia	Emb.	Precio (€)
Marrón, mate	9 4516 25 01	10	2,51
Antracita, mate	9 4516 25 05	10	2,51
Gris, brillo	9 4516 25 07	10	2,51
Blanco polar, brillo	9 4516 25 09	10	2,51
Negro, brillo	9 4516 25 10	10	2,51
Cromo, mate	8 4516 25 68	200	10,15
Acero	9 4516 25 24	10	10,15



Toma SCHUKO



9 4195 25 02

Descripción	Referencia	Emb.	Precio (€)
Marrón, mate	9 4195 25 01	10	7,46
Antracita, mate	9 4195 25 05	10	7,46
Gris, mate	9 4195 25 06	10	7,46
Blanco polar, mate	9 4195 25 02	10	7,46
Negro, mate	9 4195 05	10	7,46

- 16A, 250 V
- Protección infantil
- Conexión por tornillos

Tomos de corriente



9 6184 25 02

Toma Países Bajos

Descripción	Referencia	Emb.	Precio (€)
Marrón, mate	9 6184 25 01	10	7,89
Antracita, mate	9 6184 25 05	10	7,89
Blanco polar, mate	9 6184 25 02	10	7,89
Negro, mate	9 6184 05	10	7,89

- Tornillo con elevador



9 6194 25 02

Toma Países Bajos

Descripción	Referencia	Emb.	Precio (€)
Antracita, mate	9 6194 25 05	10	8,91
Gris, mate	9 6194 25 06	10	8,91
Blanco polar, mate	9 6194 25 02	10	8,91
Negro, mate	9 6194 05	10	8,91

- Tornillo con elevador
- Protección infantil



9 6257 25 02

Toma EURO-AMERICANA STANDARD

Descripción	Referencia	Emb.	Precio (€)
Marrón, mate	9 6257 25 01	10	12,51
Antracita, mate	9 6257 25 05	10	12,51
Gris, mate	9 6257 25 06	10	12,51
Blanco polar, mate	9 6257 25 02	10	12,51
Negro, mate	9 6257 25 03	10	12,51



9 6185 25 02

Toma con pin de tierra

Descripción	Referencia	Emb.	Precio (€)
Marrón, mate	9 6185 25 01	10	7,56
Antracita, mate	9 6185 25 05	10	7,56
Gris, mate	9 6185 25 06	10	7,56
Blanco polar, mate	9 6185 25 02	10	7,56
Negro, mate	9 6185 05	10	7,56



9 6195 25 02

Toma Francia/Bélgica

Descripción	Referencia	Emb.	Precio (€)
Marrón, mate	9 6195 25 01	10	7,94
Antracita, mate	9 6195 25 05	10	7,94
Gris, mate	9 6195 25 06	10	7,94
Blanco polar, mate	9 6195 25 02	10	7,94
Negro, mate	9 6195 05	10	7,94

- Tornillo con elevador
- Protección infantil



8 6263 25 02

Toma USA/CANADA NEMA 5-15 R

Descripción	Referencia	Emb.	Precio (€)
Blanco polar, mate	8 6263 25 02	200	18,42
Negro, mate*	8 6263 25 13	200	18,42
Marrón, mate	8 6263 25 01	200	18,42

- Zona central color marrón



8 6254 25 09

Toma USA/CANADA NEMA 6-20 R

Descripción	Referencia	Emb.	Precio (€)
Marrón, mate	8 6254 25 01	200	70,29
Antracita, mate	8 6254 25 05	200	70,29
Gris, mate	8 6254 25 07	200	70,29
Blanco polar, mate	8 6254 25 09	200	70,29
Negro, mate	8 6254 25 10	200	70,29



9 6256 25 02

Toma Australia 15A

Descripción	Referencia	Emb.	Precio (€)
Marrón, mate	9 6256 25 01	10	41,27
Antracita, mate	9 6256 25 05	10	41,27
Gris, mate	9 6256 25 06	10	41,27
Blanco polar, mate	9 6256 25 02	10	41,27
Negro, mate	9 6256 05	10	41,27



9 6272 25 02

Toma Dinamarca

Descripción	Referencia	Emb.	Precio (€)
Antracita, mate	9 6272 25 05	10	13,08
Gris, mate	9 6272 25 06	10	13,08
Blanco polar, mate	9 6272 25 02	10	13,08
Negro, mate	9 6272 05	10	13,08



9 6249 25 02

Toma Suiza Tipo 13

Descripción	Referencia	Emb.	Precio (€)
Marrón, mate	9 6249 25 01	10	18,42
Antracita, mate	9 6249 25 05	10	18,42
Gris, mate	9 6249 25 06	10	18,42
Blanco polar, mate	9 6249 25 02	10	18,42
Negro, mate	9 6249 05	10	18,42



9 6259 25 02

Toma Suiza Tipo 23

Descripción	Referencia	Emb.	Precio (€)
Marrón, mate	9 6259 25 01	10	18,42
Antracita, mate	9 6259 25 05	10	18,42
Gris, mate	9 6259 25 06	10	18,42
Blanco polar, mate	9 6259 25 02	10	18,42
Negro, mate	9 6259 25 03	10	18,42



9 6262 25 02

Toma BRITISH STANDARD

Descripción	Referencia	Emb.	Precio (€)
Marrón, mate	9 6262 25 01	10	12,11
Antracita, mate	9 6262 25 05	10	12,11
Gris, mate	9 6262 25 06	10	12,11
Blanco polar, mate	9 6262 25 02	10	12,11
Negro, mate	9 6262 05	10	12,11

Conectores



9 4517 05

Conector 12V

Descripción	Referencia	Emb.	Precio (€)
Marrón, mate	9 4517 25 01	10	13,56
Antracita, mate	9 4517 25 05	10	13,56
Gris, mate	9 4517 25 07	10	13,56
Blanco polar, mate	9 4517 25 09	10	13,56
Negro, mate	9 4517 05	10	13,56

• Para enchufe 12 V, ref. 4637



8 4571 25 09

Toma 12V

Descripción	Referencia	Emb.	Precio (€)
Marrón, mate	8 4571 25 01	200	9,71
Antracita, mate	8 4571 25 05	200	9,71
Gris, brillo	8 4571 25 07	200	9,71
Blanco polar, brillo	8 4571 25 09	200	9,71
Negro, mate	8 4571 25 03	200	9,71



4637

Enchufe 12V

Descripción	Referencia	Emb.	Precio (€)
Negro, mate	4637	1	3,22



9 2600 25 09

Toma carga USB 230V

Descripción	Referencia	Emb.	Precio (€)
Antracita, mate	9 2600 25 05	1	49,76
Blanco polar, mate	9 2600 25 09	1	49,76

TV / Audio / Video



9 4511 25 12

Toma TV box TV

Descripción	Referencia	Emb.	Precio (€)
Marrón, mate, conexión solder	9 4511 25 11	10	5,04
Antracita, mate, conexión solder	9 4511 25 15	10	5,04
Gris, mate, conexión solder	9 4511 25 16	10	5,04
Blanco polar, mate, conexión solder	9 4511 25 12	10	5,04
Negro, mate, conexión solder	9 4511 15	10	5,04
Marrón, mate, conexión F	9 4581 25 01	10	7,35
Antracita, mate, conexión F	9 4581 25 05	10	7,35
Gris, mate, conexión F	9 4581 25 06	10	7,35
Blanco polar, mate, conexión F	9 4581 25 02	10	7,35
Negro, mate, conexión F	9 4581 25 03	10	7,35



9 4519 25 02

Toma TV box SAT

Descripción	Referencia	Emb.	Precio (€)
Marrón, mate	9 4519 25 01	10	7,04
Antracita, mate	9 4519 25 05	10	7,04
Gris, mate	9 4519 25 06	10	7,04
Blanco polar, mate	9 4519 25 02	10	7,04
Negro, mate	9 4519 05	10	7,04



9 4560 25 02

Toma TV box radio/SAT

Descripción	Referencia	Emb.	Precio (€)
Marrón, mate	9 4560 25 01	10	13,97
Antracita, mate	9 4560 25 05	10	13,97
Gris, mate	9 4560 25 06	10	13,97
Blanco polar, mate	9 4560 25 02	10	13,97
Negro, mate	9 4560 05	10	13,97



9 4561 25 02

Toma TV box TV/radio

Descripción	Referencia	Emb.	Precio (€)
Blanco polar, mate	9 4561 25 02	10	13,97



8 4563 25 06

Toma TV box TV/SAT

Descripción	Referencia	Emb.	Precio (€)
Gris, mate	8 4563 25 06	200	15,61
Negro, mate	8 4563 25 03	200	15,61



1989

Cinch audio

Descripción	Referencia	Emb.	Precio (€)
Blanco polar/rojo	1989	1	46,61



1992

Cinch video

Descripción	Referencia	Emb.	Precio (€)
Blanco polar/amarillo	1992	1	24,48



1994

Módulo VGA

Descripción	Referencia	Emb.	Precio (€)
Blanco polar/negro	1994	1	91,80



1993

Módulo S-Video

Descripción	Referencia	Emb.	Precio (€)
Blanco polar/negro	1993	1	41,82



1990

Módulo 1 elemento

Descripción	Referencia	Emb.	Precio (€)
Blanco polar	1990	1	4,13

Datos / Telecomunicaciones



9 4559 25 09

Soporte para 2 módulos MINI-COM

Descripción	Referencia	Emb.	Precio (€)
Antracita, brillo	9 4559 25 05	10	2,52
Gris, brillo	9 4559 25 07	10	2,52
Blanco polar, brillo	9 4559 25 09	10	2,52
Negro, brillo	9 4559 05	10	2,52



1985

Mini jack 8 polos

Descripción	Referencia	Emb.	Precio (€)
Negro, RJ45, cat.3, compatible RDSI (AWG 24-22)	1980	1	17,24
RJ45, cat.5e, apantallado (AWG 24-22)	1984	1	23,56
RJ45, cat.6, apantallado (AWG 26)	1985	1	27,34



9 4557 25 09

Soporte para jacks modulares AMP 1 elemento

Descripción	Referencia	Emb.	Precio (€)
Antracita, brillo	9 4557 25 05	10	2,00
Gris, brillo	9 4557 25 07	10	2,00
Blanco polar, brillo	9 4557 25 09	10	2,73
Negro, brillo	9 4557 05	10	2,73

• Ref. AMP 1375188-1



8 4558 25 09

Soporte para módulos 2 BTR-/E-DAT

Descripción	Referencia	Emb.	Precio (€)
Negro, brillo	8 4558 25 10	100	5,60
Antracita, brillo	8 4558 25 05	100	5,60
Gris, brillo	8 4558 25 07	100	5,60
Blanco polar, brillo	8 4558 25 09	100	5,60

Interruptores



Conmutador 16AX, 250V

Descripción	Referencia	Emb.	Precio (€)
Marrón, mate	9 3656 25 01	10	9,04
Antracita, mate	9 3656 25 05	10	9,04
Gris, brillo	9 3656 25 07	10	9,04
Blanco polar, brillo	9 3656 25 09	10	9,04
Negro, brillo	9 3656 25 10	10	9,04
Cromo, mate	9 3656 25 68	10	16,94
Acero	9 3656 25 24	10	16,94

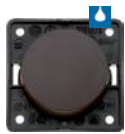

Cruzamiento, 16AX, 250V

Descripción	Referencia	Emb.	Precio (€)
Marrón, mate	9 3657 25 01	10	16,29
Antracita, mate	9 3657 25 05	10	16,29
Gris, brillo	9 3657 25 07	10	16,29
Blanco polar, brillo	9 3657 25 09	10	16,29
Negro, brillo	9 3657 25 10	10	16,29
Cromo, mate	9 3657 25 68	10	22,14
Acero	9 3657 25 24	10	22,14



2 polos Off, 16AX, 250V

Descripción	Referencia	Emb.	Precio (€)
Marrón, mate	9 3652 25 01	10	11,77
Antracita, mate	9 3652 25 05	10	11,77
Gris, brillo	9 3652 25 07	10	11,77
Blanco polar, brillo	9 3652 25 09	10	11,77
Negro, brillo	9 3652 25 10	10	11,77
Cromo, mate	9 3652 25 68	10	23,84
Acero	9 3652 25 24	10	23,84



2 polos Off con indicador luminoso, 16AX, 250V

Descripción	Referencia	Emb.	Precio (€)
Marrón, mate	9 3752 25 01	10	15,34
Antracita, mate	9 3752 25 05	10	15,34
Gris, brillo	9 3752 25 07	10	15,34
Blanco polar, brillo	9 3752 25 09	10	15,34
Negro, brillo	9 3752 25 10	10	15,34
Cromo, mate	9 3752 25 68	10	18,98
Acero	9 3752 25 24	10	18,98



2 polos Off con indicador luminoso, 5A, 12V=

Descripción	Referencia	Emb.	Precio (€)
Marrón, mate	9 3762 25 31	10	33,19
Antracita, mate	9 3762 25 35	10	33,19
Blanco polar, brillo	9 3762 25 39	10	33,19
Negro, brillo	9 3762 25 10	10	33,19
Cromo, mate	9 3762 25 68	10	39,41
Acero	9 3762 25 24	10	39,41



Interruptor doble, 16AX, 250V

Descripción	Referencia	Emb.	Precio (€)
Marrón, mate	9 3655 25 01	10	12,09
Antracita, mate	9 3655 25 05	10	12,09
Gris, brillo	9 3655 25 07	10	12,09
Blanco polar, brillo	9 3655 25 09	10	12,09
Negro, brillo	9 3655 25 10	10	12,09
Cromo, mate	9 3655 25 68	10	24,88
Acero	9 3655 25 24	10	24,88

Pulsadores



Pulsador contacto NA, 10A, 250V

Descripción	Referencia	Emb.	Precio (€)
Marrón, mate	9 3671 25 01	10	7,77
Antracita, mate	9 3671 25 05	10	7,77
Gris, brillo	9 3671 25 07	10	7,77
Blanco polar, brillo	9 3671 25 09	10	7,77
Negro, brillo	9 3671 25 10	10	7,77
Cromo, mate	9 3671 25 68	10	16,90
Acero	9 3671 25 24	10	16,90



Pulsador con indicador luminoso, 10A 250V

Descripción	Referencia	Emb.	Precio (€)
Marrón, mate	9 3772 25 01	10	17,54
Antracita, mate	9 3772 25 05	10	17,54
Gris, brillo	9 3772 25 07	10	17,54
Blanco polar, brillo	9 3772 25 09	10	17,54



Pulsador doble, 2 NA, 10A, 250V

Descripción	Referencia	Emb.	Precio (€)
Marrón, mate	9 3675 25 01	10	13,34
Antracita, mate	9 3675 25 05	10	13,34
Gris, brillo	9 3675 25 07	10	13,34
Blanco polar, brillo	9 3675 25 09	10	13,34
Negro, brillo	9 3675 25 10	10	13,34
Cromo, mate	9 3675 25 68	10	29,08
Acero	9 3675 25 24	10	29,08



Pulsador doble para persianas

Descripción	Referencia	Emb.	Precio (€)
Marrón, mate	9 3653 25 01	10	12,11
Antracita, mate	9 3653 25 05	10	12,11
Gris, brillo	9 3653 25 07	10	12,11
Blanco polar, brillo	9 3653 25 09	10	12,11
Negro, brillo	9 3653 25 10	10	12,11
Cromo, mate	9 3653 25 68	10	26,72
Acero	9 3653 25 24	10	26,72

- Enclavamiento electrónico

Reguladores



Regulador 12V= con mando, pulsante

Descripción	Referencia	Emb.	Precio (€)
Marrón, mate	9 2876 25 01	1	77,96
Antracita, mate	9 2876 25 05	1	77,96
Gris, brillo	9 2876 25 07	1	77,96
Blanco polar, brillo	9 2876 25 09	1	77,96
Negro, brillo	9 2876 25 10	1	77,96
Cromo, mate	9 2876 25 68	1	102,01
Acero	9 2876 25 24	1	102,01

- 12V incandescentes y halógenas 10-60W



Regulador con mando y marco, pulsante

Descripción	Referencia	Emb.	Precio (€)
Marrón, mate	9 2871 25 71	1	85,63
Antracita, mate	9 2871 25 75	1	85,63
Gris, brillo	9 2871 25 77	1	85,63
Blanco polar, brillo	9 2871 25 79	1	85,63

- 230V incandescentes y halógenas 60 - 400W



Regulador 1-10 con marco

Descripción	Referencia	Emb.	Precio (€)
Marrón, mate	9 2891 25 01	10	74,81
Antracita, mate	9 2891 25 05	10	74,81
Gris, brillo	9 2891 25 06	10	74,81
Blanco polar, brillo	9 2891 25 09	10	74,81

Cajas de montaje en superficie

1 elemento



9 1151 25 09

Descripción	Referencia	Emb.	Precio (€)
Marrón, mate	9 1151 25 01	10	6,83
Antracita, mate	9 1151 25 05	10	6,83
Gris brillo	9 1151 25 07	10	10,67
Blanco polar, brillo	9 1151 25 09	10	6,83
Negro, brillo	9 1151 25 10	10	10,47

1 elemento con abrazadera



9 1151 25 19

Descripción	Referencia	Emb.	Precio (€)
Marrón, mate	9 1151 25 11	10	7,99
Antracita, mate	9 1151 25 15	10	7,99
Gris brillo	9 1151 25 17	10	7,99
Blanco polar, brillo	9 1151 25 19	10	7,99
Negro, brillo	9 1151 25 20	10	10,43

1 elemento diseño plano



9 1152 25 69

Descripción	Referencia	Emb.	Precio (€)
Antracita, mate - sin abrazadera	9 1152 25 25	10	2,94
Blanco polar, brillo - sin abrazadera	9 1152 25 29	10	4,72
Antracita, mate - con abrazadera	9 1152 25 55	10	8,31
Blanco polar, brillo - con abrazadera	9 1152 25 59	10	8,39
Antracita, mate - con 2 abrazaderas	9 1152 25 65	10	4,10
Blanco polar, brillo - con 2 abrazaderas	9 1152 25 69	10	10,75

Cajas de empotrar

Gris con entrada de cable



9 1820 01

Descripción	Referencia	Emb.	Precio (€)
Estrecha, Ø 45mm, 22 mm prof.	9 1820 01*	200	1,68
Ø 45mm, 35'5 mm profundidad	9 1820 **	200	1,79

* Sólo para interruptores y pulsadores
** Para interruptores y tomas de corriente

Gris con doble entrada de cable interna



9 1887

Descripción	Referencia	Emb.	Precio (€)
Ø49 mm, 38 mm profundidad	9 1887	200	2,10

- 2 entradas de cable

Gris con entrada de cable



9 1883

Descripción	Referencia	Emb.	Precio (€)
Ø49 mm, 45'5 mm profundidad	9 1883	200	2,00

- 2 entradas de cable en la parte trasera

Caja empotrar doble



9 1915 01

Descripción	Referencia	Emb.	Precio (€)
Gris, con entrada de cable	9 1915 01	10	6,39
Gris, con 2 entradas de cable	9 1915 02	10	2,94

- 49 mm ancho, 37 mm profundo, 109 mm alto
- 2 entradas de cable

Caja empotrar triple



9 1933

Descripción	Referencia	Emb.	Precio (€)
Gris, con entrada de cable	9 1933	10	4,20

- 49 mm ancho, 38 mm profundo, 168 mm alto
- con 6 entradas de cable, 1 a cada lado, arriba, abajo y 2 en la parte trasera

Caja empotrar con abrazadera



8 1837

Descripción	Referencia	Emb.	Precio (€)
Ø 58 mm, 35 mm de profundidad	8 1837	200	2,00

Accesorios

Anillo superficie



9 1825 25 12

Descripción	Referencia	Emb.	Precio (€)
Marrón, mate	9 1825 25 11	10	2,28
Antracita, mate	9 1825 25 15	10	2,28
Gris brillo	9 1825 25 06	10	2,28
Blanco polar, brillo	9 1825 25 12	10	2,28
Negro, brillo	9 1825 25 10	10	2,28
Cromo, mate	9 1825 25 68	10	8,87
Acero	9 1825 25 24	10	8,87

Entrada cable



1813 09

Descripción	Referencia	Emb.	Precio (€)
Blanco	1813	10	1,28
Blanco polar	1813 09	10	1,84
Negro	1813 05	10	1,84

Entrada tubo



1817 09

Descripción	Referencia	Emb.	Precio (€)
Blanco polar	1817 09	10	3,57
Negro	1817 05	10	3,57

Anillo de fijación



8 1836 02

Descripción	Referencia	Emb.	Precio (€)
Gris, grosor 5 mm	8 1836	200	1,83
Gris oscuro, grosor 4 mm	8 1836 01	200	1,83
Blanco polar, grosor 6 mm	8 1836 02	200	1,47

Plantilla de fijación



9 1844

Descripción	Referencia	Emb.	Precio (€)
Gris	9 1844	10	1,47

Sellado IP44

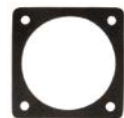

9 1853

Descripción	Referencia	Emb.	Precio (€)
Negro	9 1853	10	1,47

Esquema de montaje IP 44

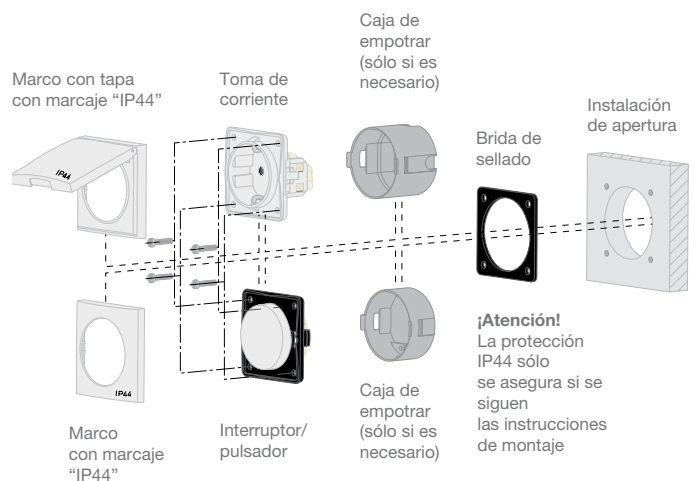

Mecanismo IP55



Estanco

cubyko IP55

Su premiado y refinado diseño se adapta a todos los entornos y resiste todas las estaciones. La flexibilidad de su gama, su montaje rápido e intuitivo, su estanqueidad perfecta IP55 y su visibilidad notable gracias al anillo luminoso de LEDs, son 4 buenas razones por las que escoger cubyko.

Más información: www.hager.es/cubyko

:hager



cubyko IP55

cubyko, la gama de mecanismos estancos, se distingue por su diseño refinado que se adapta a todos los entornos y resiste todas las estaciones. De protección IP55, puede ser opcionalmente iluminado por un LED.



cubyko IP55

Serie de mecanismos estanco IP55

La gama cubyko se distingue por su refinado diseño que se adapta a todos los entornos y resiste todas las estaciones. Idónea para ambientes rigurosos o de trabajo, garajes, piscinas...

Los módulos tebis KNX pueden integrarse en el espacio disponible y ofrece asimismo mecanismos con conexión

rápida, excepto las tomas Schuko donde los terminales son de tornillo.

Gama disponible en superficie y en empotrar y en los colores blanco polar y gris.



Ventajas:

-
- Disponible en 2 colores: gris y blanco

 - Anillos luminosos para aumentar su visibilidad

 - Diseño premiado

 - Embalaje individual

Características técnicas:

-
- Estanqueidad perfecta IP55

 - Membrana de estanqueidad total en la parte posterior

 - Estanqueidad del soporte de la tecla

 - Mecanismo con sistema de clipaje fácil, rápido e intuitivo

Más ventajas



01

2 versiones:

- Componibles : flexibilidad en la gestión del stock.
 - Monobloc : una sola referencia a gestionar.
- De empotrar y de superficie.



02

La fijación del soporte con tornillos de 1/4 de vuelta y el fácil clipaje del mecanismo son un sistema patentado por cubyko. Máximo espacio para el cableado.



03

5 elementos como la membrana que cubre toda la parte posterior de la caja, garantizan una óptima protección y total estanqueidad (patente cubyko).









04

La versión en superficie de cubyko, destaca por su gran visibilidad gracias a un anillo luminoso de LEDs, disponible en colores blanco o azul.



05

El diseño cubyko realizado por Erwin Van Handenhoven, Director de Diseño Hager Group, fue premiado en la feria Light and Building 2014.

	Monobloc superficie		Monobloc empotrar		Mecanismos componibles	
						
	gris	blanco polar	gris	blanco polar	gris	blanco polar
Interruptores 10AX - 250V ~						
- conmutador	WNC001	WNC001B	WNE001	WNE001B	WNA001	WNA001B
- conmutador luminoso (incluye lámpara 250V 0,4mA)	WNC002	-	-	-	WNA002	WNA002B
- conmutador con testigo (incluye lámpara 250V 0,75mA)	WNC003	-	-	-	WNA003	WNA003B
- conmutador con portaetiquetas	-	-	-	-	WNA006	WNA006B
- bipolar	-	-	-	-	WNA008	WNA008B
- cruzamiento	-	-	-	-	WNA010	WNA010B
Pulsadores 10A - 250V ~						
- pulsador NA	WNC020	-	-	-	WNA020	WNA020B
- pulsador NA/NC luminoso (incluye lámpara 250V 0,4mA)	WNC021	-	-	-	WNA021	WNA021B
- pulsador NA/NC	WNC022	-	-	-	WNA022	WNA022B
- pulsador NA testigo o luminoso (incluye lámpara 250V 0,75mA)	WNC023	-	WNE023	WNE023B	WNA023	WNA023B
- pulsador NA c/portaetiquetas (incluye lámpara 12-24V 0,4mA)	WNC025	-	WNE025	WNE025B	WNA025	WNA025B
Mecanismos dobles 10AX - 250V ~						
- doble conmutador	WNC040	-	WNE040	WNE040B	WNA040	WNA040B
- doble conmutador luminoso	WNC041	-	-	-	WNA041	WNA041B
- doble pulsador inversor NA/NC	WNC044	-	-	-	WNA044	WNA044B
- doble pulsador luminoso	-	-	-	-	WNA045	WNA045B
Interruptores de llave						
- 2 posiciones, con llave	WNC035	-	-	-	WNA035	-
- 3 posiciones, con llave	WNC036	-	-	-	WNA036	-
- 3 posiciones y Ø	-	-	-	-	WNA037	WNA037B
Interruptor de emergencia						
- con llave	WNC032	-	-	-	WNA032	-
- ¼ de vuelta	WNC033	-	-	-	WNA033	-
Mecanismos persianas 10AX - 250V ~						
- doble conmutador	-	-	-	-	WNA300	WNA300B
- doble pulsador	-	-	-	-	WNA301	WNA301B
Salida de cable / Tapa ciega						
- salida de cable	WNC155	WNC155B	WNE155	WNE155B	WNA155	WNA155B
- tapa ciega	-	-	-	-	WNA157	WNA157B
Tomas SCHUKO 16A - 250V ~						
- toma SCHUKO	WNC161	WNC161B	WNE161	WNE161B	WNA161	WNA161B
- toma SCHUKO doble horizontal	WNC164	-	-	-	-	-
- toma SCHUKO doble vertical	WNC174	-	-	-	-	-
- toma SCHUKO triple horizontal	WNC165	-	-	-	-	-
Adaptadores						
- adaptador para mecanismo 45x45	-	-	-	-	WNA450	-
- adaptador diámetro 22,5	-	-	-	-	WNA038	-
- adaptador KNX	WNC455	WNC455B	-	-	WNA455	WNA455B
Pilotos 10AX - 250V ~						
- verde/rojo	-	-	-	-	WNA601	-
- azul	-	-	-	-	WNA602	-
- blanco	-	-	-	-	WNA603	-

Soportes de empotrar

	elemento 1		elementos 2		elementos 3	
	gris	blanco polar	gris	blanco polar	gris	blanco polar
- simples - doble horizontal - doble vertical - triple horizontal	WNA401 - -	WNA401B - -	- WNA402 WNA408 -	- WNA402B WNA408B -	- - - WNA403	- - - WNA403B

Cajas de superficie

	elemento 1		elementos 2		elementos 3	
	gris	blanco polar	gris	blanco polar	gris	blanco polar
- 1 elemento (1+2 entradas) - 1 elemento (1+1 entradas) - doble horizontal (1+2 entradas) - doble horizontal (3x1+2 entradas) - doble vertical (1+2 entradas) - triple horizontal (2x1+2 entradas)	WNA681 WNA684 - - - -	WNA681B - - - - -	- - WNA682 WNA685 WNA686 -	- - WNA682B WNA685B WNA686B -	- - - - - WNA683	- - - - - WNA683B

Anillo luminoso (sólo para productos en superficie)

	elemento 1		elementos 2 vertical	
	230V	12 - 24V	230V	
- azul (intensidad luminosa fuerte) - blanco (intensidad luminosa débil)	WNA697 WNA695	WNA698 WNA696	- WNA699	

Accesorios cajas

	gris	blanco polar	gris	blanco polar	gris	gris	gris	gris
- entrada para 2 cables - entrada de tubo y cable - prensaestopas M20 para entrada de cable Ø 7 a 14 - unión de cajas - 2 tubos M20 - tapa tornillos	WNA690 - - - - -	WNA690B - - - - -	- WNA691 - - - -	- WNA691B - - - -	- - WNA693 - -	- - - WNA694 -	- - - WNA700 -	- - - - WNA689

Lámparas

	250V			12-24V		
	azul	rojo	blanco	azul	rojo	blanco
- para señalización 0,1 mA - para testigo 0,75 mA - cableadas, 0,4 mA - cableadas, 0,75 mA	WUZ690 WUZ696 WUZ686 -	WUZ695 WUZ691 - WUZ681	WUZ698 WUZ699 - -	WUZ692 - WUZ682 -	WUZ697 - WUZ687 -	- - - -

Series técnicas

Monobloc de superficie



WNC001

Conmutadores 10AX - 250 V AC

Descripción	Referencia	Emb.	Precio (€)
gris	WNC001	10	9,14
blanco	WNC001B	1	9,49
con indicador luminoso	WNC002	1	16,67
con testigo	WNC003	1	16,73
doble conmutador	WNC040	1	19,26
doble conmutador luminoso	WNC041	1	25,09



WNC021

Pulsadores 10A - 250 V AC

Descripción	Referencia	Emb.	Precio (€)
NA	WNC020	1	10,94
inversor luminoso NA/NC	WNC021	10	16,34
inversor NA/NC	WNC022	1	13,67
NA testigo o luminoso	WNC023	10	16,34
NA con portaetiquetas	WNC025	10	18,64
doble pulsador NA/NC	WNC044	1	21,22



WNC035

Interruptores de llave 10A - 250 V AC

Descripción	Referencia	Emb.	Precio (€)
2 posiciones	WNC035	1	91,36
3 posiciones	WNC036	1	125,54

Paro de emergencia

Descripción	Referencia	Emb.	Precio (€)
con llave	WNC032	1	92,87
1/4 de vuelta	WNC033	1	70,71



WNC161

Toma SCHUKO 16A - 250 V AC

Descripción	Referencia	Emb.	Precio (€)
gris	WNC161	10	11,79
blanco	WNC161B	1	12,52
doble horizontal	WNC164	5	27,32
doble vertical	WNC174	5	27,32
triple horizontal	WNC165	1	40,96

- Protección infantil
- Terminales con tornillos
- Las tomas dobles y triples están precableadas



WNC155

Salida de cable

Descripción	Referencia	Emb.	Precio (€)
cable ø 5 a 12 mm gris	WNC155	1	17,32
cable ø 5 a 12 mm blanco	WNC155B	1	17,72

Adaptador KNX

Descripción	Referencia	Emb.	Precio (€)
gris	WNC455	1	15,15
blanco	WNC455B	1	15,15

Monobloc de empotrar



WNE001

Conmutadores 10AX 250 V AC

Descripción	Referencia	Emb.	Precio (€)
Simple, gris	WNE001	10	14,74
Simple, blanco	WNE001B	1	14,96
Doble, gris	WNE040	10	22,36
Doble, blanco	WNE040B	1	23,03



WNE023

Pulsadores 10AX 250 V AC

Descripción	Referencia	Emb.	Precio (€)
NA testigo o luminoso, gris	WNE023	10	21,79
NA testigo o luminoso, blanco	WNE023B	1	22,74
NA portaetiquetas, gris	WNE025	10	26,57
NA portaetiquetas, blanco	WNE025B	1	26,95



WNE155

Salida de cables

Descripción	Referencia	Emb.	Precio (€)
cable ø 5 a 12 mm, gris	WNE155	1	27,96
cable ø 5 a 12 mm, blanco	WNE155B	1	28,97



WNE160

Toma SCHUKO 16A 250 V AC

Descripción	Referencia	Emb.	Precio (€)
gris	WNE161	10	16,98
blanco	WNE161B	1	17,83

- Protección infantil
- Terminales con tornillos

Interruptores



WNA002

Interruptores 10AX - 250V AC

Descripción	Referencia	Emb.	Precio (€)
Conmutador, gris	WNA001	10	6,84
Conmutador, blanco	WNA001B	1	7,41
Conm. c/indicador luminoso, gris	WNA002	10	14,83
Conm. c/indicador luminoso, blanco	WNA002B	1	15,20
Conmutador c/testigo, gris	WNA003	10	14,61
Conmutador c/testigo, blanco	WNA003B	1	15,42
Conmutador c/ p-etiq., gris	WNA006	1	15,66
Conmutador c/ p-etiq., blanco	WNA006B	1	16,13
Interruptor bipolar 0/1, gris	WNA008	10	14,83
Interruptor bipolar 0/1, blanco	WNA008B	1	15,27
Cruzamiento gris	WNA010	1	23,67
Cruzamiento blanco	WNA010B	1	24,38



WNA006B

Pulsadores



WNA020

Pulsadores 10A - 250V AC

Descripción	Referencia	Emb.	Precio (€)
NA, gris	WNA020	1	9,45
NA, blanco	WNA020B	1	9,70
NA/NC luminoso, gris	WNA021	1	14,80
NA/NC luminoso, blanco	WNA021B	1	15,25
NA/NC, gris	WNA022	10	12,33
NA/NC, blanco	WNA022B	1	12,76
NA testigo o luminoso, gris	WNA023	1	14,80
NA testigo o luminoso, blanco	WNA023B	1	15,25
NA con portaetiquetas, gris	WNA025	10	19,78
NA con portaetiquetas, blanco	WNA025B	1	20,46



WNA025

Mecanismos dobles



WNA040

Mecanismos dobles 10X - 250 V AC

Descripción	Referencia	Emb.	Precio (€)
Conmutador, gris	WNA040	10	17,37
Conmutador, blanco	WNA040B	1	18,06
Conmutador c/ind. luminoso, gris	WNA041	1	26,37
Conmutador c/ind. luminoso, blanco	WNA041B	1	27,72
Pulsador inversor, NA/NC, gris	WNA044	1	18,16
Pulsador inversor, NA/NC, blanco	WNA044B	1	18,78
Pulsador c/ ind. luminoso, gris	WNA045	1	28,72
Pulsador c/ ind. luminoso, blanco	WNA045B	1	29,71



WNA041B

Mecanismos persianas



WNA300

Descripción	Referencia	Emb.	Precio (€)
Doble conmutador, gris	WNA300	10	28,53
Doble conmutador, blanco	WNA300B	1	29,38
Pulsador doble, gris	WNA301	10	26,74
Pulsador doble, blanco	WNA301B	1	30,36

Interruptor con llave



WNA036

Descripción	Referencia	Emb.	Precio (€)
2 posiciones	WNA035	1	71,72
3 posiciones	WNA036	1	83,45
3 posiciones y extracción en 0, gris	WNA037	1	85,86
3 posiciones y extracción en 0, blanco	WNA037B	1	88,43

Paro emergencia



WNA032

Paro emergencia 10A - 250V AC

Descripción	Referencia	Emb.	Precio (€)
Con llave	WNA032	1	91,82
1/4 de vuelta	WNA033	1	74,75

- 1 NC + 1 NA

Salida de cable



WNA155

Descripción	Referencia	Emb.	Precio (€)
Salida de cable, gris	WNA155	1	16,16
Salida de cable, blanco	WNA155B	1	16,65
Tapa ciega, gris	WNA157	1	13,13
Tapa ciega, blanco	WNA157B	1	13,53

Toma SCHUKO



WNA161B

Toma SCHUKO 16A - 250V AC

Descripción	Referencia	Emb.	Precio (€)
Gris	WNA161	1	10,10
Blanco	WNA161B	1	10,39

- Protección infantil
- Terminales con tornillos

Toma de corriente francesa



WNA100

Descripción	Referencia	Emb.	Precio (€)
Gris	WNA100	10	10,02

Señalización 10AX - 250V AC



WNA601+WS609

Pilotos

Descripción	Referencia	Emb.	Precio (€)
Verde/Rojo	WNA601	1	40,40
Azul	WNA602	1	40,40
Blanco	WNA603	1	40,40



WNA602+WS606

Etiquetas

Descripción	Referencia	Emb.	Precio (€)
En blanco	WS604*	10	1,75
"Escaleras"	WS605*	10	1,75
"Ascensor"	WS606*	10	1,75
"WC"	WS607*	10	23,56
Sala "libre/ocupado"	WS608*	10	1,75
"Hotel"	WS609*	10	1,75

- Mecanismos componibles disponibles en 2 versiones:
- etiqueta en blanco, para utilización como señalización
- etiqueta impresa, para indicar una información

Estos mecanismos incluyen un tornillo de regulación de intensidad luminosa

Anillo luminoso



WNA695

Intensidad luminosa débil

Descripción	Referencia	Emb.	Precio (€)
Blanco, 230V	WNA695	1	35,35
Blanco, 12-24V	WNA696	1	35,35
Blanco x2 vertical, 230V	WNA699	1	58,59

Intensidad luminosa fuerte

Descripción	Referencia	Emb.	Precio (€)
Azul, 230V	WNA697	1	36,36
Azul, 12-24V	WNA698	1	36,36

- Solo para instalaciones en superficie

Lámparas para señalización «I»



WUZ692

Descripción	Referencia	Emb.	Precio (€)
Azul 250V	WUZ690	10	6,06
Azul 12/24V	WUZ692	10	4,14
Rojo 250V	WUZ695	10	7,07
Rojo 12/24V	WUZ697	10	4,14
Blanca 250V	WUZ698	10	5,05

- Baja intensidad luminosa
- Vida útil : 50.000h

Lámparas para testigo «L»



WUZ691

Descripción	Referencia	Emb.	Precio (€)
Rojo 250V	WUZ691	10	5,05
Azul 250V	WUZ696	10	6,57
Blanca 250V	WUZ699	10	5,05

- Alta intensidad luminosa
- Vida útil : 50.000h

Lámparas cableadas

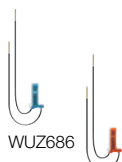

WUZ686

WUZ687

Lâmpadas com fios

Descripción	Referencia	Emb.	Precio (€)
Azul 250V	WUZ686	10	4,55
Rojo 250V	WUZ681	10	4,55
Azul 12-24V	WUZ682	10	4,55
Rojo 12-24V	WUZ687	10	4,55

- Vida útil : 50.000 h

Garras



WK696

Garras

Descripción	Referencia	Emb.	Precio (€)
Garras	WK696	50	0,88
Garras largas	WK697	50	1,01

Adaptadores



WNA450

Adaptadores

Descripción	Referencia	Emb.	Precio (€)
Para referencias systo (2 mód.)	WNA450	1	8,25
Ø diámetro 22,5 mm	WNA038	1	14,14
Adaptador KNX gris	WNA455	1	14,14
Adaptador KNX blanco	WNA455B	1	14,57

Cajas de superficie



WNA681

1 elemento

Descripción	Referencia	Emb.	Precio (€)
1 (1 entrada)+ 1 (2 entradas), gris	WNA681	10	3,30
1 (1 entrada)+ 1 (2 entradas), blanco	WNA681B	10	3,52
2 (1 entrada), gris	WNA684	10	3,30



WNA682

2 elementos horizontales

Descripción	Referencia	Emb.	Precio (€)
1 (1 entrada)+ 1 (2 entradas), gris	WNA682	5	12,16
1 (1 entrada)+ 1 (2 entradas), blanco	WNA682B	5	13,08
4 entradas. 3 (1) + 1 (2), gris	WNA685	5	12,16
4 entradas. 3 (1) + 1 (2), blanco	WNA685B	5	13,08



WNA686

2 elementos verticales

Descripción	Referencia	Emb.	Precio (€)
1 (1 entrada)+ 1 (2 entradas), gris	WNA686	5	12,16
1 (1 entrada)+ 1 (2 entradas), blanco	WNA686B	5	13,08

3 elementos horizontales

Descripción	Referencia	Emb.	Precio (€)
2 (1 entrada)+ 1 (2 entradas), gris	WNA683	5	18,68
2 (1 entrada)+ 1 (2 entradas), blanco	WNA683B	5	19,24

Soportes de empotrar



WNA401

1 elemento

Descripción	Referencia	Emb.	Precio (€)
Gris	WNA401	10	7,98
Blanco	WNA401B	10	8,17



WNA402

2 elementos horizontal

Descripción	Referencia	Emb.	Precio (€)
Gris	WNA402	5	11,35
Blanco	WNA402B	5	11,24

2 elementos vertical

Descripción	Referencia	Emb.	Precio (€)
Gris	WNA408	1	11,35
Blanco	WNA408B	1	11,24



WNA403

3 elementos horizontal

Descripción	Referencia	Emb.	Precio (€)
Gris	WNA403	5	18,98
Blanco	WNA403B	5	19,43

Accesorios para cajas



WNA690

Membrana entrada para 2 cables

Descripción	Referencia	Emb.	Precio (€)
Gris	WNA690	10	1,59
Blanco	WNA690B	10	1,07



WNA691

Membrana entrada para tubo y cable

Descripción	Referencia	Emb.	Precio (€)
Gris	WNA691	10	1,00
Blanco	WNA691B	10	1,07



WNA693

Prensaestopa M20

Descripción	Referencia	Emb.	Precio (€)
Para entrada cable Ø 7 a 14, gris	WNA693	10	8,08



WNA700

2 tubos M20

Descripción	Referencia	Emb.	Precio (€)
2 tubos M20, gris	WNA700	10	9,60

Accesorios



WNA700

Descripción	Referencia	Emb.	Precio (€)
Conector cajas en vertical	WNA694	10	2,12

Descripción	Referencia	Emb.	Precio (€)
Tapa tornillos	WNA689	5	1,00

NUEVO

Mecanismos



WNT332

Pulsadores

Descripción	Referencia	Emb.	Precio (€)
1 fase, 1 pulsador	WNT331	1	83,63
2 fases, 2 pulsadores	WNT332	1	95,99
1 fase, 2 pulsadores	WNT302	1	80,15
2 fases, 4 pulsadores	WNT304	1	85,19

Teclas dobles



WNT944

Teclas

Descripción	Referencia	Emb.	Precio (€)
Gris	WNT944	10	6,79
Blanco polar	WNT944B	10	8,19
C/ indicador luminoso, gris	WNT954	10	13,86
C/ indicador luminoso, blanco polar	WNT954B	10	13,98
C/ portaetiquetas, gris	WNT964	10	6,60
C/ portaetiquetas, blanco polar	WNT964B	10	7,10
C/ I y 0, gris	WNT974	10	6,60
C/ I y 0, blanco polar	WNT974B	10	7,10
C/ flechas, gris	WNT982	10	6,60
C/ flechas, blanco polar	WNT982B	10	7,10

Teclas simples



WNT912B

Teclas

Descripción	Referencia	Emb.	Precio (€)
Gris	WNT902	10	4,73
Blanco polar	WNT902B	10	5,20
C/ indicador luminoso, gris	WNT912	10	5,67
C/ indicador luminoso, blanco polar	WNT912B	10	6,13
C/ portaetiquetas, gris	WNT922	10	9,96
C/ portaetiquetas, blanco polar	WNT922B	10	9,99
C/ I y 0, gris	WNT932	10	5,67
C/ I y 0, blanco polar	WNT932B	10	6,13
C/ flechas, gris	WNT942	10	5,67
C/ flechas, blanco polar	WNT942B	10	6,13



WNT922

Descripción cubyko tebis le seducirá gracias a su fácil instalación, su estanqueidad a toda prueba y su ingeniosa ergonomía.

- estanqueidad IP55
- sistema de fijación con 2 tornillos de 1/4 de vuelta
- mecanismos con pilotos LEDs (según embellecedor)
- componible

Q quicklink - e easy - ETS

Funciones de entrada	Prioridad: modo manual - alarma - forzado - función de base	Modo de configuración
ON / OFF	Enciende o apaga un circuito de iluminación	e / ETS
Telerruptor	Comanda un circuito de iluminación a partir de varios pulsadores. Cada pulsación invierte el estado anterior	e / ETS
Minutero	Enciende un circuito de iluminación durante una duración definida. Un aviso de extinción parametrizable señala el fin de la temporización por una inversión del estado de la salida durante 1s	e / ETS
Dimmer 1 tecla / 2 teclas	Aumenta o disminuye progresivamente la intensidad luminosa gracias a 1 o 2 teclas	e / ETS
Persianas / Persianas 1 tecla	Permite subir o bajar una persiana y/o las lamas de un estor de lamas gracias a 1 pulsador (la función Persianas con láminas necesita obligatoriamente 2 teclas para la inclinación de las lamas)	- / ETS
Persianas / Persianas 2 teclas	Permite subir o bajar una persiana o las lamas de un estor a lamas gracias a 2 teclas	e / ETS

Funciones de entrada	WNTxxx
ON / OFF	e / ETS
Telerruptor	e / ETS
Minutero	e / ETS
Dimmer 1 tecla / 2 teclas	e / ETS
Persianas / Estores 2 teclas	e / ETS
Volets /Estores 1 tecla	- / ETS

Tomás RJ11



Toma RJ11/12

Descripción	Referencia	Emb.
Blanco	WS201	10
Aluminio	WS201T	10

WS201

Tomás RJ45



Cat. 6a

Descripción	Referencia	Emb.
Blanco	WS228	10
Negro	WS228N	10
Aluminio	WS228T	10

WS228N

Tomás TV



TV + FM

Descripción	Referencia	Emb.
Blanco	WS253	10
Negro	WS253N	10
Aluminio	WS253T	10

WS253



TV + FM + SAT 1 Entrada

Descripción	Referencia	Emb.
Blanco	WS256	10
Negro	WS256N	10
Aluminio	WS256T	10

WS256



TV + FM + SAT 2 Entradas

Descripción	Referencia	Emb.
Blanco	WS257	10
Negro	WS257N	10
Aluminio	WS257T	10

WS257

Para más funcionalidades y precios, consultar la gama systo en hager.es

berker.Net Plataforma electrónica

A través de 9 módulos de potencia y 16 módulos de aplicación, esta gama puede desarrollar hasta 400 funciones diferentes. Una oferta completa para las series S.1, B.3, B.7, Q.1, Q.3, K.1, K.5, R.1 y R.3 en convencional y tecnología radio KNX. Tan apropiado para instalaciones nuevas como para renovaciones o extensiones de instalaciones existentes.

Equipado con funciones interesantes, como regulación precisa de casi todo tipo de luminarias. Con pocos elementos, instalación sencilla y operativa intuitiva, berker.Net le ofrece una gran cantidad de opciones.



mecanismos	172
diseño	173
sistema flexible	174
guía de selección	176
catálogo de productos	179

Mecanismos Funcionalidad excepcional

Con tan sólo 9 mecanismos, las funciones electrónicas pueden superar las 400 aplicaciones. Pocos elementos para almacenar pero que permiten muchas funciones. Ideal para instalaciones simples o sistemas más complejos.



Echa un vistazo:

9 + 16 > 400

Módulos de potencia (PM)

Módulos de aplicación (AM) (convencional + knx radio)

Funciones

Interruptor 1 elemento



8512 12 00
Relé



8542 11 00
Regulador
(R, L)



8542 12 00
Regulador universal
1 elemento



8542 21 00
Regulador universal
2 elementos



8502 01 00
Alimentación
para AM radio



8512 11 00
Interruptor
1 elemento



8512 22 00
Interruptor
2 elementos



8522 11 00
Persianas confort



8532 01 00
Unidad de extensión
para detector de
movimiento

Diseño uniforme

Elegancia y pura atracción

Todos los módulos de aplicación, como los detectores de movimiento, controladores de iluminación y persianas, están disponibles en distintas estéticas.

berker.Net : excelente funcionalidad y diseño atractivo.



S.1
Tecla simple



Q.3
Tecla simple



B.7
Tecla doble KNX
radio



K.1
Pulsador superficie



B.3
Temporizador KNX
radio



S.1
Tecla persianas



Q.3
Tecla KNX radio
4 elementos



B.7
Pulsador superficie
solar



K.5
Tecla persianas



B.3
Temporizador
persianas KNX radio



S.1
Detector
movimiento



Q.1
Detector
movimiento



B.7
Detector
movimiento



K.1
Detector
movimiento



B.3
Detector
movimiento

Sistema flexible convencional y radio

berker.Net, permite tanto soluciones convencionales como aplicaciones radio. Sus aplicaciones radio bidireccionales, permiten ampliar fácilmente sistemas KNX ya existentes.

Instalación convencional

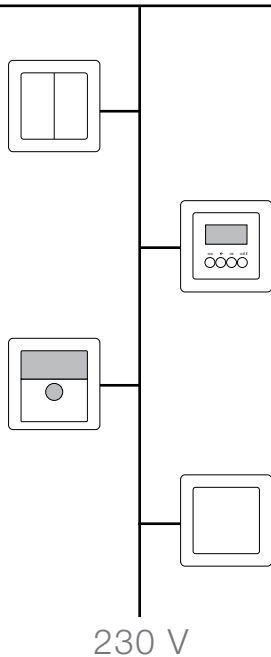
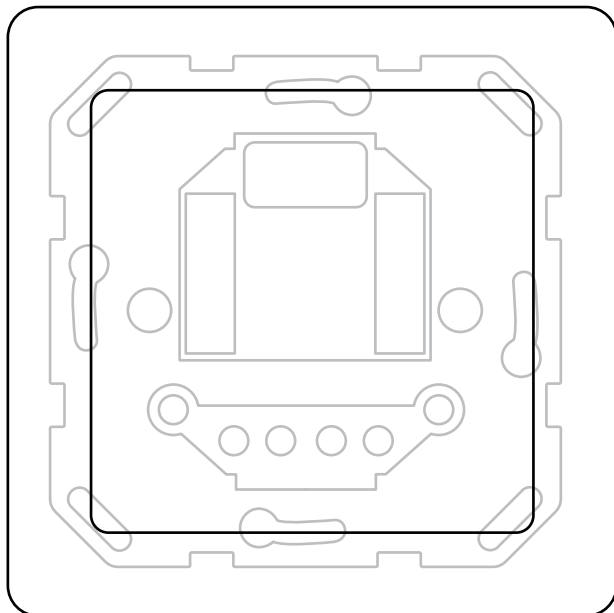

Inst. radio KNX tebis.quicklink

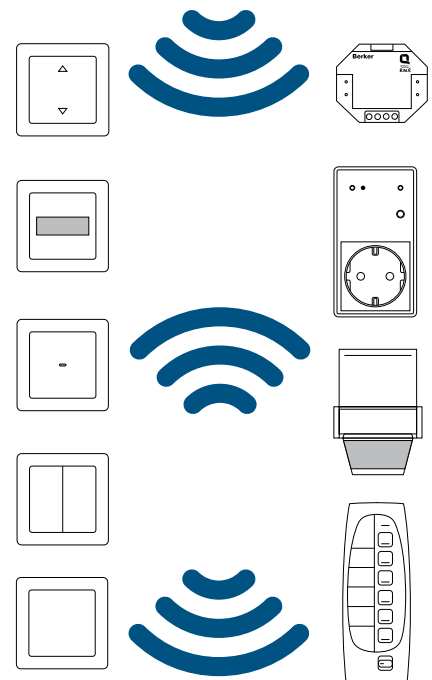
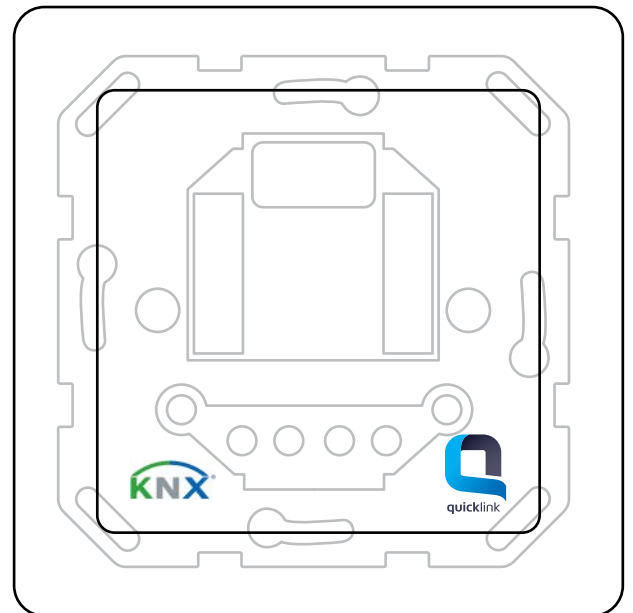

Instalación radio y bus KNX

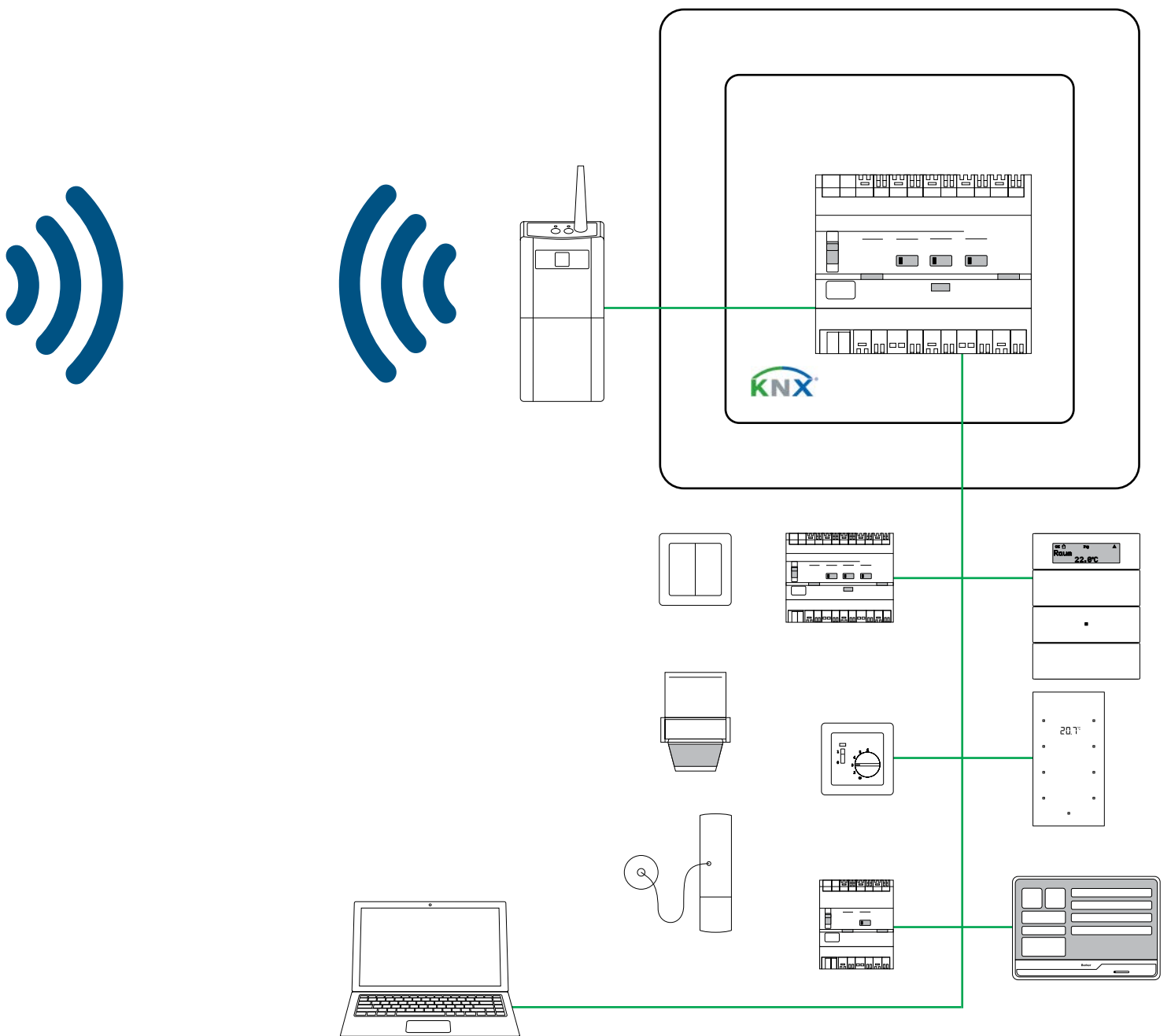

Módulos de aplicación (AM):

Convencional



Pulsador simple



Pulsador doble



Detector movimiento IR,
1,1/2,2 m



Detector movimiento IR
confort, 1,1/2,2 m



Pulsador persianas



Temporizador persianas

Módulos de potencia (PM)	Referencia	8514 11 xx	8514 21 xx	8534 11 xx 8534 21 xx	8534 12 xx 8534 22 xx	8524 11 xx	8574 11 xx	
 Interruptor 1E.	8512 11 00	■		■	■			
 1 relé	8512 12 00	■		■	■			
 Regulador (R,L)	8542 11 00	■		■	■			
 Regulador universal 1E.	8542 12 00	■		■	■			
 Interruptor 2E.	8512 22 00		■					
 Regulador universal 2E.	8542 21 00		■					
 Persianas confort	8522 11 00					■	■	
 Alimentación para AM radio	8502 01 00							
 Unidad de extensión para detectar movimiento	8532 01 00			■	■			

Módulos de aplicación (AM):
KNX radio quicklink



Pulsador KNX radio simple



Pulsador KNX radio doble



Pulsador KNX radio 4E.



Detector mov. confort, KNX radio 1,1/2,2 m



Temporizador KNX radio



Pulsador KNX radio persianas



Temporizador KNX radio persianas

	8514 51 xx	8514 61 xx	8564 81 xx	8534 51 xx 8534 61 xx	8574 52 xx	8524 52 xx	8574 51 xx
	■		■	■			
	■		■	■	■		
	■		■	■			
	■		■	■			
		■	■				
		■	■				
						■	■
	■	■	■	■	■	■	■

Mecanismo interruptor



8512 12 00

Mecanismos interruptor

Descripción	Referencia	Emb.	Precio (€)
Relé	8512 12 00	1	64,56
Interruptor de 1 elemento	8512 11 00	1	53,17
Interruptor de 2 elementos	8512 22 00	1	104,44
DALI	8542 17 00	1	110,00

Mecanismo de regulación



8542 11 00

Mecanismo regulación

Descripción	Referencia	Emb.	Precio (€)
Regulador (R, L)	8542 11 00	1	70,27
Regulador universal de 1 elemento	8542 12 00	1	87,46
Regulador universal de 2 elementos	8542 21 00	1	128,30

Detectores de movimiento



8532 01 00

Detectores de movimiento

Descripción	Referencia	Emb.	Precio (€)
Unidad extensión para det. movimiento	8532 01 00	1	40,00

Control de persianas



8522 11 00

Persianas confort

Descripción	Referencia	Emb.	Precio (€)
Persianas confort	8522 11 00	1	56,97

Alimentación para AM KNX radio



8502 01 00

Alimentación para AM KNX radio

Descripción	Referencia	Emb.	Precio (€)
Alimentación para AM KNX radio	8502 01 00	1	26,59

Control de iluminación

Teclas simples para interruptores / reguladores



berker S.1/B.3/B.7

Descripción	Referencia	Emb.	Precio (€)
Blanco, brillo	8514 11 82	1	13,30
Blanco polar, brillo	8514 11 89	1	13,30
Blanco polar, mate	8514 11 88	1	13,60
Antracita	8514 11 85	1	14,10
Aluminio	8514 11 83	1	17,42

8514 11 82



berker Q.1/Q.3

Descripción	Referencia	Emb.	Precio (€)
Blanco	8514 11 22	1	15,00
Blanco polar	8514 11 29	1	15,00
Antracita	8514 11 26	1	16,10
Aluminio	8514 11 24	1	16,10

8514 11 29



berker K.1/K.5

Descripción	Referencia	Emb.	Precio (€)
Blanco polar, brillo	8514 11 79	1	17,81
Antracita	8514 11 75	1	18,17
Aluminio	8514 11 77	1	23,04
Acero	8514 11 73	1	23,04

8514 11 79



berker R.1/R.3

Descripción	Referencia	Emb.	Precio (€)
Blanco polar, brillo	8514 11 39	1	19,00
Negro	8514 11 31	1	21,00

8514 11 39

Detectores de movimiento

Tapa detector de movimiento IR confort 1,1 m



berker S.1/B.3/B.7

Descripción	Referencia	Emb.	Precio (€)
Blanco, brillo	8534 12 82	1	111,26
Blanco polar, brillo	8534 12 89	1	111,26
Blanco polar, mate	8534 12 88	1	111,26
Antracita	8534 12 85	1	115,09
Aluminio	8534 12 83	1	118,51

8534 12 89



berker Q.1/Q.3

Descripción	Referencia	Emb.	Precio (€)
Blanco	8534 12 22	1	111,26
Blanco polar	8534 12 29	1	111,26
Antracita	8534 12 26	1	115,09
Aluminio	8534 12 24	1	115,09

8534 12 29



berker K.1/K.5

Descripción	Referencia	Emb.	Precio (€)
Blanco polar, brillo	8534 12 79	1	111,96
Antracita	8534 12 75	1	115,79
Aluminio	8534 12 77	1	119,20
Acero	8534 12 73	1	119,20

8534 12 79



berker R.1/R.3

Descripción	Referencia	Emb.	Precio (€)
Blanco polar, brillo	8534 12 39	1	111,96
Negro	8534 12 31	1	111,96

8534 12 39

Teclas dobles para interruptores / reguladores



berker S.1/B.3/B.7

Descripción	Referencia	Emb.	Precio (€)
Blanco, brillo	8514 21 82	1	18,99
Blanco polar, brillo	8514 21 89	1	18,99
Blanco polar, mate	8514 21 88	1	18,99
Antracita	8514 21 85	1	20,13
Aluminio	8514 21 83	1	24,87

8514 21 83



berker Q.1/Q.3

Descripción	Referencia	Emb.	Precio (€)
Blanco	8514 21 22	1	18,99
Blanco polar	8514 21 29	1	18,99
Antracita	8514 21 26	1	20,13
Aluminio	8514 21 24	1	20,13

8514 21 29



berker K.1/K.5

Descripción	Referencia	Emb.	Precio (€)
Blanco polar, brillo	8514 21 79	1	25,44
Antracita	8514 21 75	1	25,80
Aluminio	8514 21 77	1	30,67
Acero	8514 21 73	1	30,67

8514 21 79



berker R.1/R.3

Descripción	Referencia	Emb.	Precio (€)
Blanco polar, brillo	8514 21 39	1	29,99
Negro	8514 21 31	1	27,13

8514 21 39

Tapa detector de movimiento IR confort 2,2 m



berker S.1/B.3/B.7

Descripción	Referencia	Emb.	Precio (€)
Blanco, brillo	8534 22 82	1	111,26
Blanco polar, brillo	8534 22 89	1	111,26
Blanco polar, mate	8534 22 88	1	111,26
Antracita	8534 22 85	1	115,09
Aluminio	8534 22 83	1	118,51

8534 22 89



berker Q.1/Q.3

Descripción	Referencia	Emb.	Precio (€)
Blanco	8534 22 22	1	111,26
Blanco polar	8534 22 29	1	111,26
Antracita	8534 22 26	1	115,09
Aluminio	8534 22 24	1	115,09

8534 22 29



berker K.1/K.5

Descripción	Referencia	Emb.	Precio (€)
Blanco polar, brillo	8534 22 79	1	111,96
Antracita	8534 22 75	1	115,79
Aluminio	8534 22 77	1	119,20
Acero	8534 22 73	1	119,20

8534 22 79



berker R.1/R.3

Descripción	Referencia	Emb.	Precio (€)
Blanco polar, brillo	8534 22 39	1	111,96
Negro	8534 22 31	1	111,96

8534 22 39

Tapa detector de movimiento 1,1 m

 **berker S.1/B.3/B.7**

Descripción	Referencia	Emb.	Precio (€)
Blanco, brillo	8534 11 82	10	68,00
Blanco polar, brillo	8534 11 89	10	68,00
Blanco polar, mate	8534 11 88	10	68,00
Antracita	8534 11 85	10	71,83
Aluminio	8534 11 83	10	75,24

8534 11 89

 **berker Q.1/Q.3**

Descripción	Referencia	Emb.	Precio (€)
Blanco	8534 11 22	10	68,00
Blanco polar	8534 11 29	10	68,00
Antracita	8534 11 26	10	71,83
Aluminio	8534 11 24	10	71,83

8534 11 29

 **berker K.1/K.5**

Descripción	Referencia	Emb.	Precio (€)
Blanco polar, brillo	8534 11 79	10	68,70
Antracita	8534 11 75	10	72,53
Aluminio	8534 11 77	10	75,95
Acero	8534 11 73	10	75,95

8534 11 79

 **berker R.1/R.3**

Descripción	Referencia	Emb.	Precio (€)
Blanco polar, brillo	8534 11 39	1	68,70
Negro	8534 11 31	1	68,70

8534 11 39

Tapa detector de movimiento 2,2 m

 **berker S.1/B.3/B.7**

Descripción	Referencia	Emb.	Precio (€)
Blanco, brillo	8534 21 82	1	68,00
Blanco polar, brillo	8534 21 89	1	68,00
Blanco polar, mate	8534 21 88	1	68,00
Antracita	8534 21 85	1	71,83
Aluminio	8534 21 83	1	75,24

8534 21 89

 **berker Q.1/Q.3**

Descripción	Referencia	Emb.	Precio (€)
Blanco	8534 21 22	1	68,00
Blanco polar	8534 21 29	1	68,00
Antracita	8534 21 26	1	71,83
Aluminio	8534 21 24	1	71,83

8534 21 29

 **berker K.1/K.5**

Descripción	Referencia	Emb.	Precio (€)
Blanco polar, brillo	8534 21 79	1	68,70
Antracita	8534 21 75	1	72,53
Aluminio	8534 21 77	1	75,95
Acero	8534 21 73	1	75,95

8534 21 79

 **berker R.1/R.3**

Descripción	Referencia	Emb.	Precio (€)
Blanco polar, brillo	8534 21 39	1	68,70
Negro	8534 21 31	1	68,70

8534 21 39

Control de persianas

Teclas para persianas

 **berker S.1/B.3/B.7**

Descripción	Referencia	Emb.	Precio (€)
Blanco, brillo	8524 11 82	1	72,97
Blanco polar, brillo	8524 11 89	1	72,97
Blanco polar, mate	8524 11 88	1	72,97
Antracita	8524 11 85	1	76,80
Aluminio	8524 11 83	1	80,21

8524 11 89

 **berker Q.1/Q.3**

Descripción	Referencia	Emb.	Precio (€)
Blanco	8524 11 22	1	72,97
Blanco polar	8524 11 29	1	72,97
Antracita	8524 11 26	1	76,80
Aluminio	8524 11 24	1	76,80

8524 11 29

 **berker K.1/K.5**

Descripción	Referencia	Emb.	Precio (€)
Blanco polar, brillo	8524 11 79	1	73,80
Antracita	8524 11 75	1	77,63
Aluminio	8524 11 77	1	81,04
Acero	8524 11 73	1	81,04

8524 11 79

 **berker R.1/R.3**

Descripción	Referencia	Emb.	Precio (€)
Blanco polar, brillo	8524 11 39	1	73,80
Negro	8524 11 31	1	73,80

8524 11 39

Temporizador persianas

 **berker S.1/B.3/B.7**

Descripción	Referencia	Emb.	Precio (€)
Blanco, brillo	8574 11 82	1	139,21
Blanco polar, brillo	8574 11 89	1	139,21
Blanco polar, mate	8574 11 88	1	139,21
Antracita	8574 11 85	1	143,04
Aluminio	8574 11 83	1	146,45

8574 11 89

 **berker Q.1/Q.3**

Descripción	Referencia	Emb.	Precio (€)
Blanco	8574 11 22	1	139,21
Blanco polar	8574 11 29	1	139,21
Antracita	8574 11 26	1	143,04
Aluminio	8574 11 24	1	143,04

8574 11 29

 **berker K.1/K.5**

Descripción	Referencia	Emb.	Precio (€)
Blanco polar, brillo	8574 11 79	1	139,95
Antracita	8574 11 75	1	143,78
Aluminio	8574 11 77	1	147,20
Acero	8574 11 73	1	147,20

8574 11 79

 **berker R.1/R.3**

Descripción	Referencia	Emb.	Precio (€)
Blanco polar, brillo	8574 11 39	1	139,95
Negro	8574 11 31	1	139,95

8574 11 39

Control de iluminación - Pulsadores

Pulsador KNX radio quicklink simple



berker S.1/B.3/B.7

Descripción	Referencia	Emb.	Precio (€)
Blanco, brillo	8514 51 82	1	113,64
Blanco polar, brillo	8514 51 89	1	113,64
Blanco polar, mate	8514 51 88	1	113,64
Antracita	8514 51 85	1	117,47
Aluminio	8514 51 83	1	120,89



berker Q.1/Q.3

Descripción	Referencia	Emb.	Precio (€)
Blanco	8514 51 22	1	113,64
Blanco polar	8514 51 29	1	113,64
Antracita	8514 51 26	1	117,47
Aluminio	8514 51 24	1	117,47



berker K.1/K.5

Descripción	Referencia	Emb.	Precio (€)
Blanco polar, brillo	8514 51 79	1	114,50
Antracita	8514 51 75	1	118,33
Aluminio	8514 51 77	1	121,75
Acero	8514 51 73	1	121,75



berker R.1/R.3

Descripción	Referencia	Emb.	Precio (€)
Blanco polar, brillo	8514 51 39	1	114,50
Negro	8514 51 31	1	114,50

Pulsador KNX radio quicklink 4 elementos



berker S.1/B.3/B.7

Descripción	Referencia	Emb.	Precio (€)
Blanco, brillo	8564 81 82	1	164,46
Blanco polar, brillo	8564 81 89	1	164,46
Blanco polar, mate	8564 81 88	1	164,46
Antracita	8564 81 85	1	168,29
Aluminio	8564 81 83	1	171,71



berker Q.1/Q.3

Descripción	Referencia	Emb.	Precio (€)
Blanco	8564 81 22	1	164,46
Blanco polar	8564 81 29	1	164,46
Antracita	8564 81 26	1	168,29
Aluminio	8564 81 24	1	168,29



berker K.1/K.5

Descripción	Referencia	Emb.	Precio (€)
Blanco polar, brillo	8564 81 79	1	165,39
Antracita	8564 81 75	1	169,22
Aluminio	8564 81 77	1	172,64
Acero	8564 81 73	1	172,64



berker R.1/R.3

Descripción	Referencia	Emb.	Precio (€)
Blanco polar, brillo	8564 81 39	1	165,39
Negro	8564 81 31	1	165,39

Pulsador KNX radio quicklink doble



berker S.1/B.3/B.7

Descripción	Referencia	Emb.	Precio (€)
Blanco, brillo	8514 61 82	1	139,21
Blanco polar, brillo	8514 61 89	1	139,21
Blanco polar, mate	8514 61 88	1	139,21
Antracita	8514 61 85	1	143,04
Aluminio	8514 61 83	1	146,45



berker Q.1/Q.3

Descripción	Referencia	Emb.	Precio (€)
Blanco	8514 61 22	10	139,21
Blanco polar	8514 61 29	10	139,21
Antracita	8514 61 26	10	143,04
Aluminio	8514 61 24	10	143,04



berker K.1/K.5

Descripción	Referencia	Emb.	Precio (€)
Blanco polar, brillo	8514 61 79	1	139,95
Antracita	8514 61 75	1	143,78
Aluminio	8514 61 77	1	147,20
Acero	8514 61 73	1	147,20



berker R.1/R.3

Descripción	Referencia	Emb.	Precio (€)
Blanco polar, brillo	8514 61 39	1	139,95
Negro	8514 61 31	1	139,95

Interruptor temporizador KNX radio quicklink



berker S.1/B.3/B.7

Descripción	Referencia	Emb.	Precio (€)
Blanco, brillo	8574 52 82	1	164,46
Blanco polar, brillo	8574 52 89	1	164,46
Blanco polar, mate	8574 52 88	1	164,46
Antracita	8574 52 85	1	168,29
Aluminio	8574 52 83	1	171,71



berker Q.1/Q.3

Descripción	Referencia	Emb.	Precio (€)
Blanco	8574 52 22	1	164,46
Blanco polar	8574 52 29	1	164,46
Antracita	8574 52 26	1	168,29
Aluminio	8574 52 24	1	168,29



berker K.1/K.5

Descripción	Referencia	Emb.	Precio (€)
Blanco polar, brillo	8574 52 79	1	165,39
Antracita	8574 52 75	1	169,22
Aluminio	8574 52 77	1	172,64
Acero	8574 52 73	1	172,64



berker R.1/R.3

Descripción	Referencia	Emb.	Precio (€)
Blanco polar, brillo	8574 52 39	1	165,39
Negro	8574 52 31	1	165,39

Detectores movimiento KNX radio quicklink

Detector de movimiento confort 1,1 m.



8534 51 89

berker S.1/B.3/B.7

Descripción	Referencia	Emb.	Precio (€)
Blanco, brillo	8534 51 82	1	139,21
Blanco polar, brillo	8534 51 89	1	139,21
Blanco polar, mate	8534 51 88	1	139,21
Antracita	8534 51 85	1	143,04
Aluminio	8534 51 83	1	146,45



8534 51 29

berker Q.1/Q.3

Descripción	Referencia	Emb.	Precio (€)
Blanco	8534 51 22	1	139,21
Blanco polar	8534 51 29	1	139,21
Antracita	8534 51 26	1	143,04
Aluminio	8534 51 24	1	143,04



8534 51 79

berker K.1/K.5

Descripción	Referencia	Emb.	Precio (€)
Blanco polar, brillo	8534 51 79	1	139,95
Antracita	8534 51 75	1	143,78
Aluminio	8534 51 77	1	147,20
Acero	8534 51 73	1	147,20



8534 51 39

berker R.1/R.3

Descripción	Referencia	Emb.	Precio (€)
Blanco polar, brillo	8534 51 39	1	139,95
Negro	8534 51 31	1	139,95

Detector de movimiento confort 2,2 m.



8534 61 89

berker S.1/B.3/B.7

Descripción	Referencia	Emb.	Precio (€)
Blanco, brillo	8534 61 82	1	139,21
Blanco polar, brillo	8534 61 89	1	139,21
Blanco polar, mate	8534 61 88	1	139,21
Antracita	8534 61 85	1	143,04
Aluminio	8534 61 83	1	146,45



8534 61 29

berker Q.1/Q.3

Descripción	Referencia	Emb.	Precio (€)
Blanco	8534 61 22	1	139,21
Blanco polar	8534 61 29	1	139,21
Antracita	8534 61 26	1	143,04
Aluminio	8534 61 24	1	143,04



8534 61 79

berker K.1/K.5

Descripción	Referencia	Emb.	Precio (€)
Blanco polar, brillo	8534 61 79	1	139,95
Antracita	8534 61 75	1	143,78
Aluminio	8534 61 77	1	147,20
Acero	8534 61 73	1	147,20



8534 61 39

berker R.1/R.3

Descripción	Referencia	Emb.	Precio (€)
Blanco polar, brillo	8534 61 39	1	139,95
Negro	8534 61 31	1	139,95

Control de persianas

Teclas persianas KNX vía radio quicklink - Pulsador



8524 51 89

berker S.1/B.3/B.7

Descripción	Referencia	Emb.	Precio (€)
Blanco, brillo	8524 52 82	1	126,27
Blanco polar, brillo	8524 52 89	1	126,27
Blanco polar, mate	8524 52 88	1	126,27
Antracita	8524 52 85	1	130,10
Aluminio	8524 52 83	1	133,52



8524 51 29

berker Q.1/Q.3

Descripción	Referencia	Emb.	Precio (€)
Blanco	8524 52 22	1	126,27
Blanco polar	8524 52 29	1	126,27
Antracita	8524 52 26	1	130,10
Aluminio	8524 52 24	1	130,10



8524 52 79

berker K.1/K.5

Descripción	Referencia	Emb.	Precio (€)
Blanco polar, brillo	8524 52 79	1	127,23
Antracita	8524 52 75	1	131,06
Aluminio	8524 52 77	1	134,48
Acero	8524 52 73	1	134,48



8524 51 39

berker R.1/R.3

Descripción	Referencia	Emb.	Precio (€)
Blanco polar, brillo	8524 52 39	1	127,33
Negro	8524 52 31	1	127,33

Temporizador persianas KNX radio quicklink



8574 51 89

berker S.1/B.3/B.7

Descripción	Referencia	Emb.	Precio (€)
Blanco, brillo	8574 51 82	1	164,46
Blanco polar, brillo	8574 51 89	1	164,46
Blanco polar, mate	8574 51 88	1	164,46
Antracita	8574 51 85	1	168,29
Aluminio	8574 51 83	1	171,71



8574 51 29

berker Q.1/Q.3

Descripción	Referencia	Emb.	Precio (€)
Blanco	8574 51 22	1	164,46
Blanco polar	8574 51 29	1	164,46
Antracita	8574 51 26	1	168,29
Aluminio	8574 51 24	1	168,29



8574 51 79

berker K.1/K.5

Descripción	Referencia	Emb.	Precio (€)
Blanco polar, brillo	8574 51 79	1	165,39
Antracita	8574 51 75	1	169,22
Aluminio	8574 51 77	1	172,64
Acero	8574 51 73	1	172,64



8574 51 39

berker R.1/R.3

Descripción	Referencia	Emb.	Precio (€)
Blanco polar, brillo	8574 51 39	1	165,39
Negro	8574 51 31	1	165,39

Emisores KNX radio - Pulsadores superficie

Pulsador de superficie KNX radio quicklink simple



8565 52 89

berker S.1/B.3/B.7

Descripción	Referencia	Emb.	Precio (€)
Blanco, brillo	8565 52 82	1	117,20
Blanco polar, brillo	8565 52 89	1	117,20
Blanco polar, mate	8565 52 88	1	117,20
Antracita	8565 52 85	1	124,20
Aluminio	8565 52 83	1	120,90



8565 52 29

berker Q.1/Q.3

Descripción	Referencia	Emb.	Precio (€)
Blanco	8565 52 22	1	117,20
Blanco polar	8565 52 29	1	117,20
Antracita	8565 52 26	1	124,20
Aluminio	8565 52 24	1	124,20



8565 52 79

berker K.1/K.5

Descripción	Referencia	Emb.	Precio (€)
Blanco polar, brillo	8565 52 79	1	118,01
Antracita	8565 52 75	1	121,71
Aluminio	8565 52 77	1	125,01
Acero	8565 52 73	1	125,01



8565 52 39

berker R.1/R.3

Descripción	Referencia	Emb.	Precio (€)
Blanco polar, brillo	8565 52 39	1	118,01
Negro	8565 52 31	1	118,01

Pulsador superficie KNX radio quicklink doble



8565 62 89

berker S.1/B.3/B.7

Descripción	Referencia	Emb.	Precio (€)
Blanco, brillo	8565 62 82	1	141,80
Blanco polar, brillo	8565 62 89	1	141,80
Blanco polar, mate	8565 62 88	1	141,80
Antracita	8565 62 85	1	145,50
Aluminio	8565 62 83	1	148,80



8565 62 29

berker Q.1/Q.3

Descripción	Referencia	Emb.	Precio (€)
Blanco	8565 62 22	1	141,80
Blanco polar	8565 62 29	1	141,80
Antracita	8565 62 26	1	145,50
Aluminio	8565 62 24	1	145,50



8565 62 79

berker K.1/K.5

Descripción	Referencia	Emb.	Precio (€)
Blanco polar, brillo	8565 62 79	1	142,60
Antracita	8565 62 75	1	146,30
Aluminio	8565 62 77	1	149,60
Acero	8534 62 73	1	149,60



8565 62 39

berker R.1/R.3

Descripción	Referencia	Emb.	Precio (€)
Blanco polar, brillo	8565 62 39	1	142,60
Negro	8565 62 31	1	142,60

Pulsador de superficie KNX radio quicklink solar simple



8565 51 89

berker S.1/B.3/B.7

Descripción	Referencia	Emb.	Precio (€)
Blanco, brillo	8565 51 82	1	117,20
Blanco polar, brillo	8565 51 89	1	117,20
Blanco polar, mate	8565 51 88	1	117,20
Antracita	8565 51 85	1	120,90
Aluminio	8565 51 83	1	124,20



8565 51 39

berker R.1/R.3

Descripción	Referencia	Emb.	Precio (€)
Blanco polar, brillo	8565 51 39	1	118,01
Negro	8565 51 31	1	118,01

Pulsador superficie KNX radio quicklink solar doble



8565 61 89

berker S.1/B.3/B.7

Descripción	Referencia	Emb.	Precio (€)
Blanco, brillo	8565 61 82	1	141,70
Blanco polar, brillo	8565 61 89	1	141,70
Blanco polar, mate	8565 61 88	1	141,70
Antracita	8565 61 85	1	145,40
Aluminio	8565 61 83	1	148,70



8565 61 39

berker R.1/R.3

Descripción	Referencia	Emb.	Precio (€)
Blanco polar, brillo	8565 61 39	1	142,60
Negro	8565 61 31	1	142,60

Series de mecanismos Soluciones KNX

Hager ofrece teclados con todos los acabados existentes de las series de mecanismos modular convencional.

De esta forma, es posible completar una instalación con teclados KNX manteniendo la misma estética que las series de mecanismos convencional: schuko, tomas de TV, teléfono, red, etc.

Los teclados KNX están disponibles en distintas versiones (1,2,4,... fases) que permiten adaptarse a las necesidades del usuario final.



Series de mecanismos KNX

pág.

berker TS, TS Crystal, TS Sensor , Touch Sensor	186
KNX berker	192
sensor KNX, CO ₂	196
berker Touch Sensor confort	197
berker B.IQ	199
berker B.IQ, EnOcean	201
NUEVO berker Touch control KNX	203
termostato digital y controlador de ambiente	204
NUEVO pulsadores KNX con acoplador de bus integrado	206
teclados KNX berker	208



berker TS / TS Crystal

Tras una apariencia de pura elegancia, este modelo esconde una gran variedad de posibilidades técnicas. Con berker TS no solo podrá manejar diversas fuentes de luz, sino también el sistema para control de edificios KNX.



reddot award





berker TS Sensor

La discreción es un arte, y berker TS Sensor es su consumación. Distintas funciones se ocultan bajo una superficie de cristal puro que prácticamente se funde con la pared, y se puede etiquetar de forma personalizada a petición.



DESIGNPREIS
2007
NOMINIERT



DESIGNPREIS
2008
NOMINIERT



product
design
award
2007



red dot award



PLUS & AWARD
Design



GOOD
DESIGN





berker Touch Sensor R.1/R.3

Los Teclados Touch Sensor están disponibles en dos acabados: con contornos suaves (R.1) y angulosos (R.3), así como en superficies de cristal negro y blanco polar. Gracias a su acoplador de bus integrado, permiten leer y controlar una gran variedad de funciones para instalaciones KNX.



product
design award

2013



reddot design award
winner 2013



Montaje

Los sensores de cristal van en una caja de empotrar doble para sensor de cristal y Crystal Ball' usando pasadores ajustables de tal manera que los sensores de cristal están casi 'sentados' en la pared. El anillo adaptador suministrado proporciona protección anti-desmontaje y da a la placa de cristal un contorno sombreado. Los pasadores de retención ajustables se pueden utilizar para compensar la desviación de la profundidad o las irregularidades de la pared de hasta 20 mm.

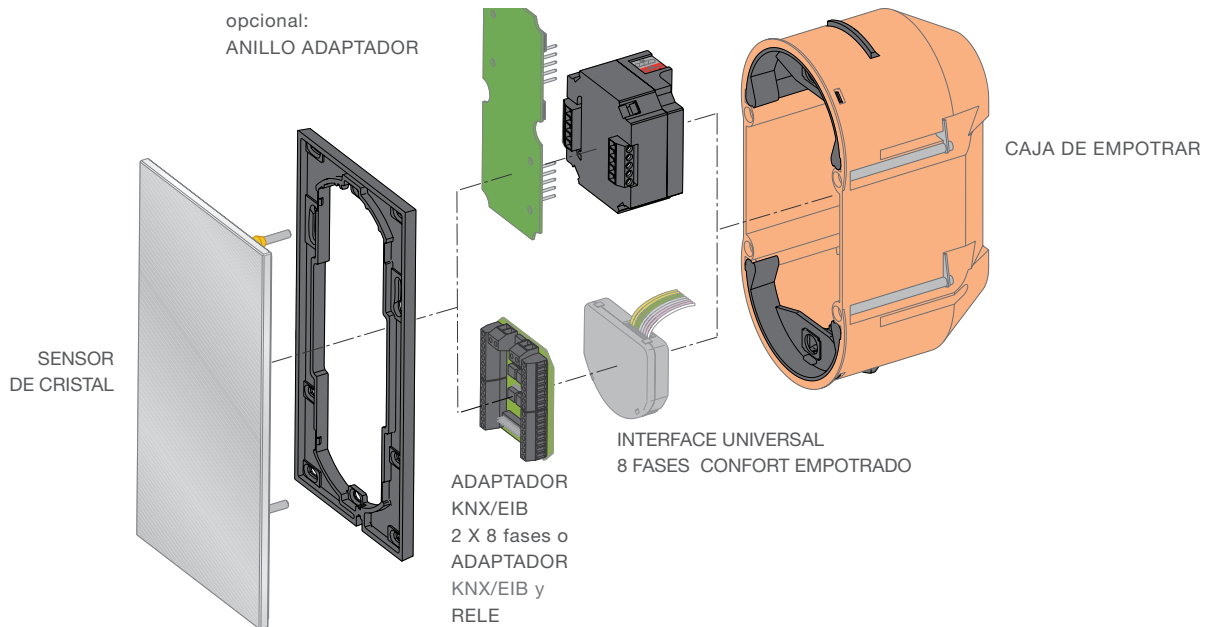

Conexión

El sensor de cristal está conectado a los interfaces de los sistemas respectivos a través de un adaptador usando un cable (ver información para pedidos y uso). La fuente de alimentación separada tiene que estar conectada al adaptador de red correspondiente.

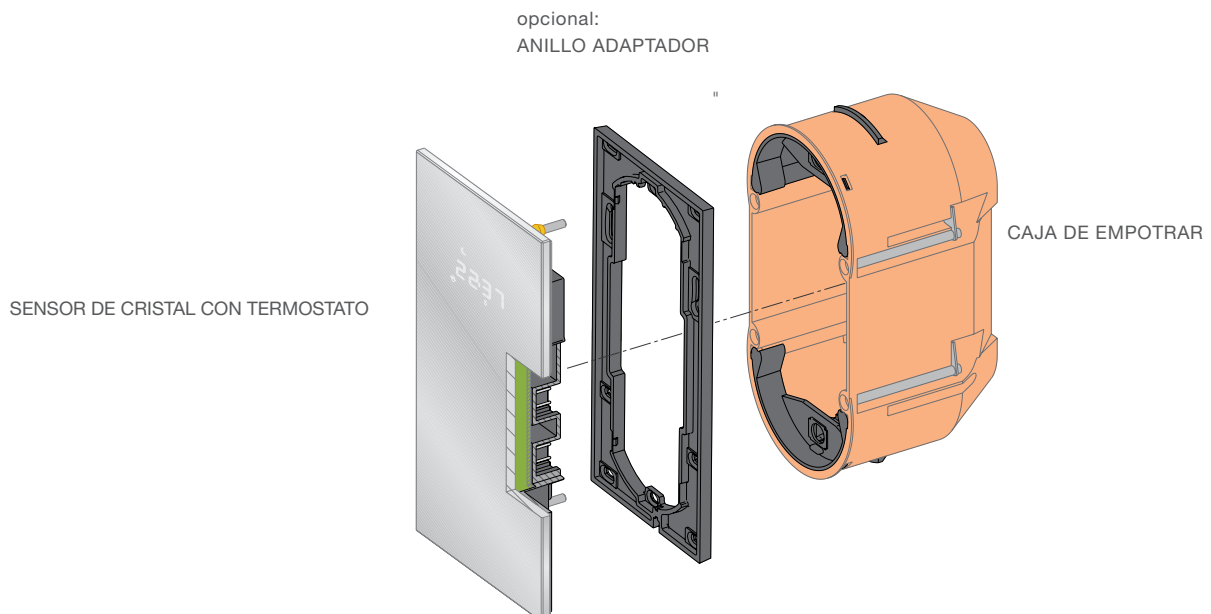

Conexión

El sensor de cristal con termostato de ambiente está conectado directamente al adaptador KNX / EIB y fuente de alimentación independiente utilizando los terminales de conexión situados en la parte trasera.

Desmontaje

Para sacar los sensores de cristal de los resortes de sujeción de la caja de empotrar, utilice la ayuda proporcionada por las ventosas incluidas.

Placas centrales TS



1394

Placa cristal

Descripción	Referencia	Emb.	Precio (€)
Blanco, 1 elemento	1391	1	62,83
Blanco, 2 elementos	1392	1	69,05
Blanco, 4 elementos	1394	1	91,19

- Utilizar cajas de empotrar ref. 1809, 1824



1341

Placa cristal con borde biselado

Descripción	Referencia	Emb.	Precio (€)
Blanco, 1 elemento	1311	1	61,61
Blanco, 2 elementos	1321	1	69,05
Blanco, 4 elementos	1341	1	91,19
Blanco, 6 elementos	1366	1	217,87
Blanco, 8 elementos	1388	1	278,05

- Utilizar cajas de empotrar ref. 1809, 1824

Pulsadores



1811 13

Pulsador TS

Descripción	Referencia	Emb.	Precio (€)
Cromo	1811 10	10	30,22
Oro	1811 12	10	37,43
Acero	1811 13	10	42,94



1964 00 01

Pulsador TS Crystal

Descripción	Referencia	Emb.	Precio (€)
Crystal - Cromo	1964 00 01	1	82,85
Black Diamond - Acero	1966 02 15	1	118,03
Siam - Oro	1965 02 08	1	102,65
Topaz - Oro	1965 02 03	1	102,65

- CRYSTALLIZEDTM - Swarovski Elements

Accesorios TS



1809

Caja de empotrar

Descripción	Referencia	Emb.	Precio (€)
Caja empotrar	1809	50	12,67
Caja pared hueca	1824	50	16,25



1895 10

Tornillo

Descripción	Referencia	Emb.	Precio (€)
Cromo	1895 10	1	8,88
Oro	1895 12	1	8,90
Acero	1895 13	1	9,70

Sensores confort TS Sensor

Sensor 1 fase

Descripción	Referencia	Emb.	Precio (€)
Cristal, blanco polar	7514 18 30	1	229,86
Cristal, negro	7514 18 35	1	233,31
Cristal, aluminio	7514 10 34	1	215,40
Cristal, blanco polar, configurado	7514 19 30	1	424,21
Cristal, negro, configurado	7514 19 35	1	424,21
Cristal, aluminio, configurado	7514 11 34	1	424,21

7514 18 30

Sensor 2 fases

Descripción	Referencia	Emb.	Precio (€)
Cristal, blanco polar	7514 28 30	1	240,65
Cristal, negro	7514 28 35	1	340,60
Cristal, aluminio	7514 20 34	1	259,74
Cristal, blanco polar, configurado	7514 29 30	1	430,21
Cristal, negro, configurado	7514 29 35	1	430,21
Cristal, aluminio, configurado	7514 21 34	1	430,21

7514 28 30

Sensor 3 fases

Descripción	Referencia	Emb.	Precio (€)
Cristal, blanco polar	7514 38 30	1	280,01
Cristal, negro	7514 38 35	1	302,04
Cristal, aluminio	7514 30 34	1	280,01
Cristal, blanco polar, configurado	7514 39 30	1	440,00
Cristal, negro, configurado	7514 39 35	1	440,00
Cristal, aluminio, configurado	7514 31 34	1	440,00

7514 38 30

Sensor 4 fases

Descripción	Referencia	Emb.	Precio (€)
Cristal, blanco polar	7514 48 30	1	324,74
Cristal, negro	7514 48 35	1	324,74
Cristal, aluminio	7514 40 34	1	324,74
Cristal, blanco polar, configurado	7514 49 30	1	450,21
Cristal, negro, configurado	7514 49 35	1	450,21
Cristal, aluminio, configurado	7514 41 34	1	450,21

7514 48 30

Sensor 2 fases con termostato

Descripción	Referencia	Emb.	Precio (€)
Cristal, blanco polar	7564 20 30	1	389,95
Cristal, negro	7564 20 35	1	500,36
Cristal, aluminio	7564 20 34	1	500,36
Cristal, blanco polar, configurado	7564 21 30	1	566,19
Cristal, negro, configurado	7564 21 35	1	566,19
Cristal, aluminio, configurado	7564 21 34	1	566,19

7564 20 35

Sensor 3 fases con termostato

Descripción	Referencia	Emb.	Precio (€)
Cristal, blanco polar	7564 30 30	1	421,55
Cristal, negro	7564 30 35	1	544,25
Cristal, aluminio	7564 30 34	1	544,25
Cristal, blanco polar, configurado	7564 31 30	1	610,08
Cristal, negro, configurado	7564 31 35	1	610,08
Cristal, aluminio, configurado	7564 31 34	1	610,08

7564 30 30

- Sensores confort TS Sensor con BCU integrada

Accesorios TS Sensor



7590 00 32

Adaptador KNX y relé

Descripción	Referencia	Emb.	Precio (€)
Adaptador KNX 2x8	7590 00 31	1	40,33

- Solo ETS



1870

Caja de empotrar

Descripción	Referencia	Emb.	Precio (€)
Caja empotrar 68x139x75 mm	1870	1	25,28
Caja empotrar 68x139x47,5 mm	1871	1	25,28

Termostatos



7544 12 29

Termostato con BCU sin control manual

Descripción	Referencia	Emb.	Precio (€)
S.1/B.3/B.7, blanco, brillo	7544 12 52	1	225,56
S.1/B.3/B.7, blanco polar, brillo	7544 12 59	1	226,36
S.1/B.3/B.7, blanco polar, mate	7544 12 89	1	226,36
S.1/B.3/B.7, antracita	7544 12 85	1	227,16
S.1/B.3/B.7, aluminio	7544 12 83	1	230,04
Q.1/Q.3, blanco polar	7544 12 29	1	226,36
Q.1/Q.3, antracita	7544 12 26	1	226,36
K.1/K.5, blanco polar, brillo	7544 12 79	1	226,36
K.1/K.5, antracita	7544 12 75	1	227,16
K.1/K.5, acero	7544 12 73	1	230,78
K.1/K.5, aluminio, mate	7544 12 71	1	235,16

Tapa ciega



7594 02 29

Descripción	Referencia	Emb.	Precio (€)
S.1/B.3/B.7, blanco, brillo	7594 02 52	1	6,62
S.1/B.3/B.7, blanco polar, brillo	7594 02 59	1	7,89
S.1/B.3/B.7, blanco polar, mate	7594 02 89	1	7,89
S.1/B.3/B.7, antracita	7586 02 85	1	8,22
S.1/B.3/B.7, aluminio	7594 02 83	1	10,11
Q.1/Q.3 blanco polar	7594 02 29	1	7,89
K.1 / K.5 blanco polar, brillo	7594 02 79	1	7,89
K.1 / K.5 antracita	7594 02 75	1	8,22
K.1 / K.5 acero	7594 02 73	1	10,63

- Para BCUs empotradas.
- BCU: ref. 7504 00 01, 7504 00 03

Accesorios - etiquetas DIN A4

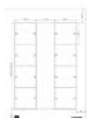

9498 29 01

Descripción	Referencia	Emb.	Precio (€)
Para teclados de 1 fase, 8 etiquetas	9498 29 01	1	33,16
Para teclados de 2 fases, 18 etiquetas	9498 30 02	1	36,10
Para teclados de 3 fases, 30 etiquetas	9498 31 03	1	36,05
Para teclados de 4 fases, 42 etiquetas	9498 32 04	1	35,92

Respire tranquilo

En muchos edificios que están altamente aislados no hay intercambio de aire regularmente. Esta situación afecta al clima de trabajo y estudio de escuelas, universidades y oficinas.

Los sensores de CO₂ monitorizan la calidad del aire y la humedad así como la temperatura. De esta manera, la instalación KNX puede tomar las medidas oportunas para regular los niveles según interese desde abrir ventanas a activar ventilación o ajustar los sistemas de clima.

- Detección de la concentración de dióxido de carbono, humedad relativa y temperatura
- 2 entradas binarias para contactos de ventana o pulsadores
- Programable via ETS4/5
- Disponible en distintos acabados berker S/B, Q y K



Sensor KNX CO₂

S.x / B.x		Referencia	Precio (€)
7544 13 52	Descripción		
	Blanco brillo	7544 13 52	297,00
	Blanco polar brillo	7544 13 59	297,00
	Blanco polar mate	7544 13 89	297,00
	Antracita	7544 13 85	300,24
	Aluminio	7544 13 83	300,24

Q.x		Referencia	Precio (€)
7544 13 26	Descripción		
	Blanco polar	7544 13 29	297,00
	Blanco	7544 13 22	297,00
	Antracita	7544 13 26	300,24
	Aluminio	7544 13 24	300,24

K.x		Referencia	Precio (€)
7544 13 75	Descripción		
	Blanco polar brillo	7544 13 79	297,00
	Antracita, mate	7544 13 75	300,24
	Aluminio	7544 13 71	324,00
	Acero inoxidable	7544 13 73	324,00
	Bronce	7544 13 81	324,00

Teclado berker Touch Sensor confort



7514 18 60

Teclado 1 fase confort

Descripción	Referencia	Emb.	Precio (€)
Teclado R.1, cristal blanco polar	7514 18 60	1	265,49
Teclado R.1, cristal negro	7514 18 65	1	265,49
Teclado R.1, config., cristal blanco polar	7514 11 60	1	268,72
Teclado R.1, config., cristal negro	7514 11 65	1	268,72
Teclado R.3, cristal blanco polar	7514 18 50	1	233,04
Teclado R.3, cristal negro	7514 18 55	1	233,04
Teclado R.3, config., cristal blanco polar	7514 11 50	1	238,72
Teclado R.3, config., cristal negro	7514 11 55	1	238,72



7514 28 60

Teclado 2 fases confort

Descripción	Referencia	Emb.	Precio (€)
Teclado R.1, cristal blanco polar	7514 28 60	1	270,03
Teclado R.1, cristal negro	7514 28 65	1	270,03
Teclado R.1, config., cristal blanco polar	7514 21 60	1	272,02
Teclado R.1, config., cristal negro	7514 21 65	1	272,02
Teclado R.3, cristal blanco polar	7514 28 50	1	270,03
Teclado R.3, cristal negro	7514 28 55	1	270,03
Teclado R.3, config., cristal blanco polar	7514 21 50	1	272,02
Teclado R.3, config., cristal negro	7514 21 55	1	272,02



7514 38 60

Teclado 3 fases confort

Descripción	Referencia	Emb.	Precio (€)
Teclado R.1, cristal blanco polar	7514 38 60	1	280,01
Teclado R.1, cristal negro	7514 38 65	1	280,01
Teclado R.1, config., cristal blanco polar	7514 31 60	1	311,40
Teclado R.1, config., cristal negro	7514 31 65	1	311,40
Teclado R.3, cristal blanco polar	7514 38 50	1	280,01
Teclado R.3, cristal negro	7514 38 55	1	280,01
Teclado R.3, config., cristal blanco polar	7514 31 50	1	311,40
Teclado R.3, config., cristal negro	7514 31 55	1	311,40



7514 48 65

Teclado 4 fases confort

Descripción	Referencia	Emb.	Precio (€)
Teclado R.1, cristal blanco polar	7514 48 60	1	324,74
Teclado R.1, cristal negro	7514 48 65	1	324,74
Teclado R.1, config., cristal blanco polar	7514 41 60	1	356,12
Teclado R.1, config., cristal negro	7514 41 65	1	356,12
Teclado R.3, cristal blanco polar	7514 48 50	1	324,74
Teclado R.3, cristal negro	7514 48 55	1	324,74
Teclado R.3, config., cristal blanco polar	7514 41 50	1	356,12
Teclado R.3, config., cristal negro	7514 41 55	1	356,12



7564 20 60

Teclado 2 fases con termostato

Descripción	Referencia	Emb.	Precio (€)
Teclado R.1, cristal blanco polar	7564 20 60	1	389,95
Teclado R.1, cristal negro	7564 20 65	1	389,95
Teclado R.1, config., cristal blanco polar	7564 21 60	1	421,33
Teclado R.1, config., cristal negro	7564 21 65	1	421,33
Teclado R.3, cristal blanco polar	7564 20 50	1	389,95
Teclado R.3, cristal negro	7564 20 55	1	389,95
Teclado R.3, config., cristal blanco polar	7564 21 50	1	421,33
Teclado R.3, config., cristal negro	7564 21 55	1	421,33



7564 30 60

Teclado 3 fases con termostato

Descripción	Referencia	Emb.	Precio (€)
Teclado R.1, cristal blanco polar	7564 30 60	1	421,55
Teclado R.1, cristal negro	7564 30 65	1	421,55
Teclado R.1, config., cristal blanco polar	7564 31 60	1	452,93
Teclado R.1, config., cristal negro	7564 31 65	1	452,93
Teclado R.3, cristal blanco polar	7564 30 50	1	421,55
Teclado R.3, cristal negro	7564 30 55	1	421,55
Teclado R.3, config., cristal blanco polar	7564 31 50	1	452,93
Teclado R.3, config., cristal negro	7564 31 55	1	452,93

Pulsador con BCU



7516 18 69

Teclado 1 fase confort

Descripción	Referencia	Emb.	Precio (€)
Teclado y BCU	7504 10 04	1	157,98
Tecla blanco polar, brillo	7516 18 69	1	10,04
Tecla negro, brillo	7516 18 65	1	9,46



7516 28 69

Teclado 2 fases confort

Descripción	Referencia	Emb.	Precio (€)
Teclado y BCU	7504 20 04	1	168,50
Tecla blanco polar, brillo	7516 28 69	1	11,59
Tecla negro, brillo	7516 28 65	1	13,02

- BCU integrada en teclados KNX de la serie R.1 y R.3
- Cajas: empotrar - ref. 1809
pared hueca - ref. 1824

KNX
series de mecanismos



berker B.IQ

Además de la sencilla funcionalidad KNX, berker B.IQ ofrece una gran variedad de materiales y colores. Sus superficies se corresponden exactamente con las de berker B.7, el cual constituye un compañero ideal para B.IQ gracias a sus interruptores y tomas Schuko.



DESIGNPREIS
2006
NOMINIERT



DESIGNPREIS
2007
NOMINIERT



design award
winner
2004



reddot design award
winner 2004



Designpreis der
Bundesrepublik
Deutschland
Nominiert 2004

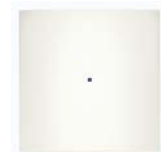

Teclados estándar



Blanco polar, mate

Descripción	Referencia	Emb.	Precio (€)
1 fase	7516 10 99	1	45,84
2 fases	7516 20 99	1	55,82
3 fases	7516 30 99	1	71,69
4 fases (*)	7516 40 99	1	83,26

7516 30 99



Aluminio

Descripción	Referencia	Emb.	Precio (€)
1 fase	7516 10 94	1	74,38
2 fases	7516 20 94	1	109,27
3 fases	7516 30 94	1	118,99
4 fases (*)	7516 40 94	1	164,31

7516 30 94



Acero

Descripción	Referencia	Emb.	Precio (€)
1 fase	7516 10 93	1	71,74
2 fases	7516 20 93	1	94,75
3 fases	7516 30 93	1	111,14
4 fases (*)	7516 40 93	1	190,20

7516 10 93



Cristal blanco polar

Descripción	Referencia	Emb.	Precio (€)
1 fase	7516 10 90	1	88,72
2 fases	7516 20 90	1	121,33
3 fases	7516 30 90	1	162,40
4 fases (*)	7516 40 90	1	203,81

7516 30 90



Cristal negro

Descripción	Referencia	Emb.	Precio (€)
1 fase	7516 10 92	1	88,72
2 fases	7516 20 92	1	121,33
3 fases	7516 30 92	1	162,40
4 fases (*)	7516 40 92	1	203,81

7516 30 92

- Medidas: 88,5 x 88,5 mm excepto (*): 88,5 x 118,1 mm
- BCU: ref. 7504 00 01
- Accesorio etiquetas: ref. 7590 00 80 (81 para el de 4 fases)

Teclados confort



Blanco polar, mate

Descripción	Referencia	Emb.	Precio (€)
1 fase	7516 15 99	1	74,01
2 fases	7516 25 99	1	84,70
3 fases	7516 35 99	1	98,87
4 fases (*)	7516 45 99	1	113,69

7516 35 99



Aluminio

Descripción	Referencia	Emb.	Precio (€)
1 fase	7516 15 94	1	103,15
2 fases	7516 25 94	1	127,66
3 fases	7516 35 94	1	142,84
4 fases (*)	7516 45 94	1	179,60

7516 15 94



Acero

Descripción	Referencia	Emb.	Precio (€)
1 fase	7516 15 93	1	99,91
2 fases	7516 25 93	1	123,64
3 fases	7516 35 93	1	138,34
4 fases (*)	7516 45 93	1	173,95

7516 15 93



Cristal blanco polar

Descripción	Referencia	Emb.	Precio (€)
1 fase	7516 15 90	1	117,82
2 fases	7516 25 90	1	151,12
3 fases	7516 35 90	1	190,50
4 fases (*)	7516 45 90	1	235,22

7516 35 90



Cristal negro

Descripción	Referencia	Emb.	Precio (€)
1 fase	7516 15 92	1	117,82
2 fases	7516 25 92	1	151,12
3 fases	7516 35 92	1	190,50
4 fases (*)	7516 45 92	1	235,22

7516 15 92

- Medidas: 88,5 x 88,5 mm excepto (*): 88,5 x 118,1 mm
- BCU: ref. 7504 00 01
- Accesorio etiquetas: ref. 7590 00 80 (81 para el de 4 fases)

Teclados de escenas iluminación



Teclados escenas iluminación 4 fases confort con portaetiquetas

Descripción	Referencia	Emb.	Precio (€)
4 fases, blanco polar, mate	7516 86 99	1	136,26
4 fases, aluminio	7516 86 94	1	202,89
4 fases, acero	7516 86 93	1	196,50
4 fases, cristal blanco polar	7516 86 90	1	258,53
4 fases, cristal negro	7516 86 92	1	258,53

7516 86 93

- Medidas: 88,5 x 118,1 mm
- BCU: ref. 7504 00 01
- Accesorio etiquetas: ref. 7590 00 81

Teclados con termostato y display



Blanco polar, mate

Descripción	Referencia	Emb.	Precio (€)
3 fases	7566 35 99	1	240,31
4 fases	7566 45 99	1	307,46
5 fases	7566 55 99	1	348,20

7566 35 99



Aluminio

Descripción	Referencia	Emb.	Precio (€)
3 fases	7566 35 94	1	288,86
4 fases	7566 45 94	1	379,64
5 fases	7566 55 94	1	430,23

7566 35 94



Acero

Descripción	Referencia	Emb.	Precio (€)
3 fases	7566 35 93	1	279,78
4 fases	7566 45 93	1	367,69
5 fases	7566 55 93	1	416,68

7566 35 93



Cristal blanco polar

Descripción	Referencia	Emb.	Precio (€)
3 fases	7566 35 90	1	332,03
4 fases	7566 45 90	1	435,30
5 fases	7566 55 90	1	506,81

7566 35 90



Cristal negro

Descripción	Referencia	Emb.	Precio (€)
3 fases	7566 35 92	1	332,03
4 fases	7566 45 92	1	435,30
5 fases	7566 55 92	1	506,81

7566 35 92

- Medidas: (3 fases) 88,5 x 119,6 mm (4 fases) 88,5 x 149,2 mm (5 fases) 88,5 x 178,8 mm
- BCU: ref. 7504 00 03
- Accesorio etiquetas: ref. 7590 00 80 (3 fases) / 7590 00 81 (4 fases) / 75900082 (5 fases)

Teclados IR con termostato y display



7566 36 99

Blanco polar, mate

Descripción	Referencia	Emb.	Precio (€)
3 fases	7566 36 99	1	267,17
4 fases	7566 46 99	1	334,32
5 fases	7566 56 99	1	375,05



7566 36 94

Aluminio

Descripción	Referencia	Emb.	Precio (€)
3 fases	7566 36 94	1	316,56
4 fases	7566 46 94	1	407,38
5 fases	7566 56 94	1	457,96



7566 36 93

Acero

Descripción	Referencia	Emb.	Precio (€)
3 fases	7566 36 93	1	306,59
4 fases	7566 46 93	1	394,56
5 fases	7566 56 93	1	443,55



7566 36 90

Cristal blanco polar

Descripción	Referencia	Emb.	Precio (€)
3 fases	7566 36 90	1	364,23
4 fases	7566 46 90	1	463,02
5 fases	7566 56 90	1	534,53



7566 36 92

Cristal negro

Descripción	Referencia	Emb.	Precio (€)
3 fases	7566 36 92	1	364,23
4 fases	7566 46 92	1	463,02
5 fases	7566 56 92	1	534,53

- Medidas: (3 fases) 88,5 x 128,6 mm (4 fases) 88,5 x 158,2 mm (5 fases) 88,5 x 187,8 mm
- BCU: ref. 7504 00 03
- Accesorio etiquetas: ref. 7590 00 80 (3 fases) / 7590 00 81 (4 fases) / 75900082 (5 fases)

Accesorios



7590 00 80

Etiquetas

Descripción	Referencia	Emb.	Precio (€)
Etiquetas B.IQ, 1,2 y 3 fases	7590 00 80	1	8,95
Etiquetas B.IQ, 4 fases	7590 00 81	1	12,93
Etiquetas B.IQ, 5 fases	7590 00 82	1	17,00

BCU



7504 00 01

Descripción	Referencia	Emb.	Precio (€)
BCU	7504 00 01	1	91,80
BCU plus	7504 00 03	1	91,80

EnOcean



2411 12 00

Módulo radio EnOcean

Descripción	Referencia	Emb.	Precio (€)
Módulo radio EnOcean	2411 12 00	1	76,39

Tecla simple EO

Descripción	Referencia	Emb.	Precio (€)
Blanco polar brillo	2411 11 89	10	2,60
Blanco polar mate	2411 11 09	10	2,60
Antracita	2411 11 06	10	3,01



2411 12 89

Tecla simple persiana EO

Descripción	Referencia	Emb.	Precio (€)
Blanco polar brillo	2411 12 89	10	3,49
Blanco polar mate	2411 12 09	10	3,49
Antracita	2411 12 06	10	3,92



2412 11 89

Tecla doble EO

Descripción	Referencia	Emb.	Precio (€)
Blanco polar brillo	2412 11 89	10	4,90
Blanco polar mate	2412 11 09	10	4,90
Antracita	2412 11 06	10	5,22



2412 12 89

Tecla doble persiana EO

Descripción	Referencia	Emb.	Precio (€)
Blanco polar brillo	2412 12 89	10	6,77
Blanco polar mate	2412 12 09	10	6,77
Antracita	2412 12 06	10	7,03



2412 13 89

Tecla doble luz y persiana EO

Descripción	Referencia	Emb.	Precio (€)
Blanco polar brillo	2412 13 89	10	5,84
Blanco polar mate	2412 13 09	10	5,84
Antracita	2412 13 06	10	6,16

berker KNX Touch Control diseño y función

Gracias a sus 10 páginas configurables, es posible escoger los elementos KNX que quieren gestionarse. El dispositivo puede memorizar hasta 16 escenarios y puede protegerse con una contraseña. Incluye una protección antirobo: para proteger el dispositivo contra la desinstalación no

deseada, se necesita una herramienta específica para sacarlo del soporte. Gracias a los conectores externos, se puede añadir un sensor de temperatura exterior (EK090) o contactos binarios.



Ventajas:

- Usabilidad excepcional: > 190 iconos existentes o personalizables (accesibles desde la tarjeta micro SD)
- Hasta 10 páginas diferentes posibles
- Montaje muy simple
- Visualización personalizable
- Distintos embellecedores con ángulos redondeados o marcados que ofrecen múltiples acabados
- Programación ETS

Características técnicas:

- Acoplador de bus integrado
- Pantalla capacitiva: - 3,5"
- Resolución: - 320 x 240 pixeles
- Alimentación externa: - 24 V DC + bus 30V DC
- Montaje en: - caja empotrar estándar

Touch control KNX



Touch control KNX

Descripción	Referencia	Precio (€)
KNX Touch Control	7574 01 01	748,85

7574 01 01



1319 60 82

Marco redondeado

Descripción	Referencia	Precio (€)
Blanco mate	1319 60 82	6,51
Blanco polar brillo	1319 21 89	6,51
Blanco polar mate	1319 60 89	6,51
Aluminio mate	1319 60 84	6,51
Antracita mate	1319 60 86	6,51
Negro, brillo	1319 21 45	6,51
Cristal blanco polar	1319 21 09	45,07
Cristal, negro	1319 21 16	45,07
Aluminio anodizado	1319 21 84	62,40
Acero inoxidable	1319 21 04	62,40

NUEVO

Sensor de temperatura externa KNX **EK090** 26,90



EK090



1319 89 82

Marco angular

Descripción	Referencia	Precio (€)
Blanco, brillo	1319 89 82	6,51
Blanco mate	1319 60 99	6,51
Blanco polar, brillo	1319 70 09	6,51
Blanco polar mate	1319 19 09	6,51
Aluminio, mate	1319 64 24	6,51
Antracita, mate	1319 70 06	6,51
Negro, brillo	1319 22 45	6,51
Cristal, blanco polar	1319 69 09	45,07
Cristal, aluminio	1319 64 14	45,07
Cristal, negro	1319 66 16	45,07
Aluminio anodizado	1319 22 84	90,61
Acero inoxidable	1319 22 04	90,61
Acero inoxidable cepillado	1319 36 06	90,61

Termostato digital y controlador de ambiente

Los nuevos termostatos KNX impresionan por su concepto innovador: las funciones pueden activarse pasando y pulsando. Bajo la pantalla color TFT de 1,93" hay un área que combina opciones operativas capacitivas con mecánicas. Puedes desplazarte por las páginas del menú deslizando y seleccionar la función pulsando.

El controlador de estancias KNX no sólo gestiona la temperatura de la estancia, sino también otras nueve funciones parametrizables.



Ventajas:

- Termostato para gestionar la temperatura
 - Distintos acabados disponibles
 - Admite la conexión de un sensor de temperatura externo
 - 13 idiomas integrados
-

Características técnicas:

- Pantalla color TFT 1.93"
 - Sensor de temperatura integrado
 - Superficie operativa capacitiva con puntos de pulsación mecánica
 - Reloj con 4h de reserva
 - Programación ETS + easy
-

Termostato digital



Termostato digital

Descripción	Referencia	Precio (€)
Termostato digital	8044 01 00	230,00

8044 01 00



Controlador de ambiente

Descripción	Referencia	Precio (€)
Controlador de ambiente	8066 01 00	295,00

8066 01 00



8096 01 89

Marcos

Descripción	Referencia	Precio (€)
S/B, blanco brillo	8096 01 82	9,20
S/B, blanco polar brillo	8096 01 89	9,20
S/B, blanco polar mate	8096 01 80	9,50
S/B, antracita	8096 01 85	10,10
S/B, aluminio	8096 01 83	10,50
Q.x, blanco polar	8096 01 29	9,50
Q.x, antracita	8096 01 26	10,10
K.x, blanco polar	8096 01 79	12,50
K.x, antracita	8096 01 75	12,50
K.x, aluminio	8096 01 71	20,00

Pulsadores KNX con acoplador de bus integrado

Los pulsadores KNX tienen la apariencia de unos pulsadores convencionales pero, gracias a su acoplador de bus y sensor de temperatura integrado, comparten ventajas con los teclados. Estos elementos KNX encajan perfectamente en instalaciones optimizadas en coste.

De apariencia simple pero inteligentes: se conectan a la instalación KNX a través del acoplador de bus. El LED de estado RGB en cada tecla, ofrece también un valor añadido.



Ventajas:

- Disponibles en distintos acabados: S.x / B.x / Q.x / K.x
- Color LED RGB configurable
- Un LED de estado por tecla

Características técnicas:

- 1 ó 2 pulsadores
- Sensor de temperatura integrado
- BCU integrada
- Programación easy y ETS

Pulsadores KNX con BCU integrada



1 fase

Descripción	Referencia	Precio (€)
S.x / B.x	8014 11 80	72,29
Q.x / K.x	8014 11 70	72,29

8014 11 70



Tecla 1 fase

Descripción	Referencia	Precio (€)
S.1, blanco, brillo	8096 02 82	3,23
S.x/B.x, blanco polar brillo	8096 02 89	3,23
S.x/B.x, blanco polar mate	8096 02 99	3,23
S.x/B.x, aluminio	8096 02 83	5,50
S.x/B.x, antracita	8096 02 85	3,62
Q.x, blanco	8096 02 22	3,23
Q.x, blanco polar	8096 02 29	3,23
Q.x, antracita	8096 02 26	3,62
Q.x, aluminio	8096 02 21	3,62

8096 02 82

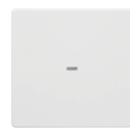

8096 02 29

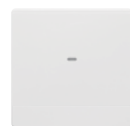

K.1 blanco polar	8096 02 79	5,50
K.1 antracita	8096 02 75	5,58
K.5, aluminio	8096 02 71	9,28
K.5, acero	8096 02 73	9,28

8096 02 79

NUEVO

Tecla 1 fase, flechas



Descripción	Referencia	Precio (€)
S.x/B.x, blanco, brillo	8096 12 82	9,86
S.x/B.x, blanco polar brillo	8096 12 89	9,86
S.x/B.x, blanco polar mate	8096 12 99	9,66
S.x/B.x, antracita	8096 12 85	10,06
S.x/B.x, aluminio	8096 12 83	11,28

8096 12 82

NUEVO



Q.x, blanco	8096 12 22	9,07
Q.x, blanco polar	8096 12 29	9,07
Q.x, antracita	8096 12 26	11,67
Q.x, aluminio	8096 12 21	11,67

8096 12 22

NUEVO

Tecla 1 fase, I/O



Descripción	Referencia	Precio (€)
S.x/B.x, blanco, brillo	8096 22 82	10,25
S.x/B.x, blanco polar brillo	8096 22 89	10,25
S.x/B.x, blanco polar mate	8096 22 99	10,25
S.x/B.x, antracita	8096 22 85	10,25
S.x/B.x, aluminio	8096 22 83	11,67

8096 22 82

NUEVO



Q.x, blanco	8096 22 22	9,07
Q.x, blanco polar	8096 22 29	9,07
Q.x, antracita	8096 22 26	11,67
Q.x, aluminio	8096 22 21	11,67

8096 22 22

K.1 blanco polar	8096 22 79	10,06
K.1 antracita	8096 22 75	11,47
K.5, aluminio	8096 22 71	16,88
K.5, acero	8096 22 73	16,88

Nota: Referencias no compatibles con el sistema anterior



2 fases

Descripción	Referencia	Precio (€)
S.x / B.x	8014 21 80	85,51
Q.x / K.x	8014 21 70	85,51

8014 21 80



Tecla 2 fases

Descripción	Referencia	Precio (€)
S/B, blanco	8096 03 82	6,25
S/B, blanco polar brillo	8096 03 89	6,25
S/B, blanco polar mate	8096 03 99	6,25
S/B, aluminio	8096 03 83	8,38
S/B, antracita	8096 03 85	6,49

8096 03 82



8096 03 29

Q.x, blanco polar	8096 03 29	6,25
Q.x, antracita	8096 03 26	6,49

K.1, blanco polar	8096 03 79	8,29
K.1, antracita	8096 03 75	8,34
K.5, aluminio	8096 03 71	13,54
K.5, acero	8096 03 73	13,54

NUEVO

Tecla 2 fases, flechas

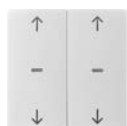

Descripción	Referencia	Precio (€)
S.x/B.x, blanco, brillo	8096 13 82	17,70
S.x/B.x, blanco polar brillo	8096 13 89	17,70
S.x/B.x, blanco polar mate	8096 13 99	18,50
S.x/B.x, antracita	8096 13 85	18,50
S.x/B.x, aluminio	8096 13 83	20,11

8096 13 82

NUEVO



Q.x, blanco	8096 13 22	17,70
Q.x, blanco polar	8096 13 29	17,70
Q.x, antracita	8096 13 26	20,51
Q.x, aluminio	8096 13 21	28,55

8096 13 22

NUEVO

Tecla 2 fases, I/O



Descripción	Referencia	Precio (€)
S.x/B.x, blanco, brillo	8096 23 82	12,46
S.x/B.x, blanco polar brillo	8096 23 89	12,46
S.x/B.x, blanco polar mate	8096 23 99	12,46
S.x/B.x, antracita	8096 23 85	13,09
S.x/B.x, aluminio	8096 23 83	15,10

8096 23 22

NUEVO

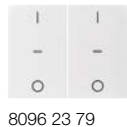

Q.x, blanco	8096 23 22	17,70
Q.x, blanco polar	8096 23 29	17,70
Q.x, antracita	8096 23 26	17,70
Q.x, aluminio	8096 23 21	30,76

8096 23 79

K.x blanco polar	8096 23 79	13,48
K.x antracita	8096 23 75	15,69
K.x, aluminio	8096 23 71	16,09
K.x, acero	8096 23 73	29,37

KNX series de mecanismos

Teclados KNX berker S.x, B.x, Q.x, K.x, R.x

Los nuevos teclados son modulares en diseño: un único acoplador de bus funciona con todos los teclados. Las teclas tienen LEDs RGB de estado regulables y parametrizables y se incluye un sensor de temperatura.

Respecto de la programación, se simplifica existiendo una única aplicación de alto nivel para todas las series y las distintas variantes de 1 a 4 fases. Este factor y el zumbador integrado en la BCU, hace la instalación de estos elementos mucho más sencilla.



Ventajas:

- Disponible en distintas series: S.x / B.x / Q.x / K.x / R.x
- Pulsadores con LED RGB de estado personalizables
- Integración en la decoración, gracias a los distintos acabados a elegir para las teclas centrales
- Oferta completa

Características técnicas:

- 2, 4, 6 y 8 pulsadores (1 a 4 fases)
- Sensor de temperatura integrado
- Zumbador integrado para facilitar la localización del producto en la instalación
- Programación easy y ETS

Teclados KNX



8004 00 01

Acopladores de bus

Descripción	Referencia	Precio (€)
BCU	8004 00 01	91,80
BCU (10x)	8004 00 11	918,00



8016 17 80

Teclado 1 fase

Descripción	Referencia	Precio (€)
S/B, blanco / blanco polar	8016 17 80	58,09
S/B, aluminio / antracita	8016 17 85	59,42
Q.x, blanco polar	8014 13 29	58,09
Q.x, antracita	8014 13 26	59,42
K.x, blanco / blanco polar	8016 17 70	58,09
K.x, antracita	8016 17 76	59,42
K.x, aluminio	8016 17 74	59,42
K.x, acero	8016 17 73	61,10
R.x, blanco polar	8016 18 69	59,42
R.x, negro	8016 18 65	58,09



8016 27 80

Teclado 2 fases

Descripción	Referencia	Precio (€)
S/B, blanco / blanco polar	8016 27 80	69,33
S/B, aluminio / antracita	8016 27 85	70,72
Q.x, blanco polar	8014 23 29	69,33
Q.x, antracita	8014 23 26	70,72
K.x, blanco / blanco polar	8016 27 70	69,33
K.x, antracita	8016 27 76	70,72
K.x, aluminio	8016 27 74	70,72
K.x, acero	8016 27 73	72,80
R.x, blanco polar	8016 28 69	69,33
R.x, negro	8016 28 65	70,72



8016 37 80

Teclado 3 fases

Descripción	Referencia	Precio (€)
S/B, blanco / blanco polar	8016 37 80	88,76
S/B, aluminio / antracita	8016 37 85	90,54
Q.x, blanco polar	8014 33 29	90,54
Q.x, antracita	8014 33 26	88,76
K.x, blanco / blanco polar	8016 37 70	88,76
K.x, antracita	8016 37 76	90,54
K.x, aluminio	8016 37 74	90,54
K.x, acero	8016 37 73	93,42



8016 47 80

Teclado 4 fases

Descripción	Referencia	Precio (€)
S/B, blanco / blanco polar	8016 47 80	100,25
S/B, aluminio / antracita	8016 47 85	101,95
Q.x, blanco polar	8014 43 29	100,25
Q.x, antracita	8014 43 26	101,95
K.x, blanco / blanco polar	8016 47 70	100,25
K.x, antracita	8016 47 76	101,95
K.x, aluminio	8016 47 74	101,95
K.x, acero	8016 47 73	103,40

• Utilizar el marco KNX excepto para la ref. Q.X

Detectores de movimiento KNX



8026 21 80

1,10 m

Descripción	Referencia	Precio (€)
S/B	8026 21 80	170,21
K.x / Q.x	8026 21 70	170,21
R.x	8026 21 60	170,21



8026 22 80

2,20 m

Descripción	Referencia	Precio (€)
S/B	8026 22 80	170,21
K.x / Q.x	8026 22 70	170,21
R.x	8026 22 60	170,21



8096 04 52

Tapas para detectores KNX

Descripción	Referencia	Precio (€)
S/B, blanco	8096 04 52	6,84
S/B, blanco polar	8096 04 59	6,84
S/B, aluminio	8096 04 83	10,77
S/B, antracita	8096 04 85	8,95
Q.x, blanco polar	8096 04 29	6,84
Q.x, antracita	8096 04 26	8,95
K.x, blanco polar	8096 04 79	10,96
K.x, antracita	8096 04 75	11,25
K.x, aluminio	8096 04 71	13,37
K.x, acero	8096 04 73	13,37
R.x, blanco polar	8096 04 60	10,96
R.x, negro	8096 04 65	11,25

Nota: Referencias no compatibles con el sistema anterior

Soluciones KNX tebis

La oferta tebis de Hager está compuesta por una amplia gama de productos que funcionan bajo protocolo KNX y proporcionan al instalador la posibilidad de incrementar el valor de sus instalaciones. Hager incorpora continuamente a su oferta nuevos productos, que aportan soluciones, modulables y evolutivas, a las necesidades del instalador en la medida que responden a las demandas del usuario para realizar un control más eficiente de la energía, hacer su vida más confortable e incrementar su seguridad.



	presentación sistema tebis KNX	212
NUEVO	modo de configuración quicklink	214
NUEVO	modo de configuración easy	220
NUEVO	modo de configuración ETS	232
	domovea	244
NUEVO	controlador IoT	244
	pantallas táctiles	245

Oferta KNX tebis

Gestión inteligente del edificio

El sistema tebis soporta el conjunto de funciones eléctricas de la instalación (iluminación, aperturas motorizadas, calefacción) y las hace interactuar a través de prestaciones domóticas evolucionadas (funciones lógicas, cuadro de mando energético,...).

La tecnología KNX garantiza la perennidad y la interoperatividad de sus instalaciones. En función de las características de su instalación y de su obra, hager propone 3 modos de configuración complementarias.

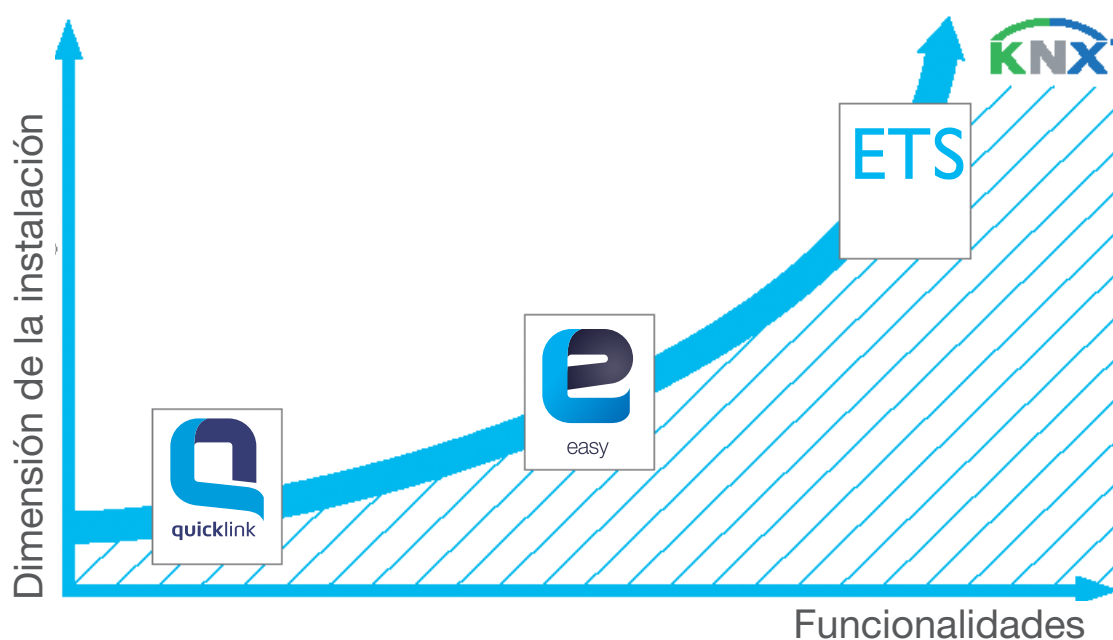

tebis,

Presentación de los modos de configuración



quicklink

La programación se realiza directamente sobre los aparatos, sin herramienta específica. El modo **quicklink**  es ideal para pequeños proyectos y extensiones de proyectos.



easy

Ideal para instalaciones medianas con productos con bus y/o RF. Ofrece un acceso a numerosas funciones KNX sin utilizar ETS. Simple y rápida, la programación se realiza vía TXA100.



ETS

La solución para las instalaciones más exigentes. Acceso a todas las posibilidades de los productos tebis gracias al software **ETS**.

quicklink

La domótica simplificada

tebis.quicklink es una oferta domótica basada en un modo de configuración nuevo: ¡el modo quicklink! Sin necesidad de formación ni de herramienta de configuración específica.

Aplicaciones sencillas, muy rápidas de configurar y con todas las ventajas de una instalación KNX.



Ventajas:

- La domótica KNX sin necesidad de formación
- Extrema simplicidad de configuración
- Sin obras ni cableado
- Sin herramienta de programación ni PC

Características técnicas:

- Oferta radio KNX 868,3 MHz
- Configuración quicklink sin herramienta, directamente sobre los productos
- Alcance: 100 m en campo libre
- Configurable quicklink, easy, ETS
- Gestión de aplicaciones de iluminación, regulación, persianas, ON/OFF, escenas, forzados, comandos de grupo...

Más ventajas



01

1 función = 1 color
Programación intuitiva
mediante código de colores
y símbolos.



02

Kit preconfigurado
Para una instalación aún
más rápida y sencilla.
Detector de movimiento y
actuador ON/OFF.



03

El tamaño reducido de
los nuevos micromódulos
permite tener mucho más
espacio para el cableado.



04

Vía radio, para una
instalación sin obras
ni cableado.



05

Los productos tebis
configurables quicklink
también admiten la confi-
guración ETS, permitiendo
la ampliación en el futuro.

tebis.quicklink

Aplicaciones y ventajas

tebis.quicklink, es ideal para la rehabilitación y sus ventajas son múltiples: sin necesidad de obras, de instalación rápida, es fácil de programar y garantiza un ahorro y gestión eficiente de la energía. Además, es modular y evolutivo.



01 Tomas de corriente



04 Iluminación exterior



07 Regulación



02 Pulsadores IP55



05 Series de mecanismos convencionales



08 Iluminación ON / OFF



03 Detectores de presencia



06 Mandos a distancia























09 Toldos/persianas



quicklink es el modo de configuración sin herramienta de Hager. La configuración se realiza con los pulsadores situados en los productos.

Estos productos permiten el mando de la iluminación, de las persianas y de los toldos receptores funcionando en ON/OFF. Asimismo se pueden crear escenarios, comandos de grupos,...



	Entradas	Salidas	Entradas / salidas
Interior	Módulos de 2 entradas  TRM702A baterías  TRB302B 230V	Módulos 1 salida  TRB201 ON/OFF	Módulo 2 entradas / 1 salida  TRM690G ON/OFF, 2 hilos TRM693G ON/OFF, 3 hilos
	Mandos a distancia  TU402/TU404 2 y 4 entradas TU406 6 entradas TU418 18 entradas Detectores  TRC301B apertura TRC321B luminosidad	Toma comandada  TRC270D ON/OFF	 TRM691E regulación, 2 hilos TRM692G persiana
Exterior IP55	Detectores de movimiento  TRE520 batería - blanco  TRE521 batería - antracita  TRE530 solar - blanco  TRE531 solar - antracita	Módulos salida ON/OFF  TRE201 1 salida  TRE202 2 salidas	Kit preconfigurado  TRE720 1 detector IR blanco + 1 receptor 1 salida 10 A IP55 <hr/> Foco LED con detector  TRE600
	Pulsadores IP 55  TRE301 1 entrada  TRE302 2 entradas	Módulo 1 salida  TRE221 persiana	Módulo 1 entrada / 1 salida  TRE400 ON / OFF

Módulos de 2 entradas, empotrar

Descripción	Referencia	Precio (€)
Batería, CR2430, 3V	TRM702A	49,28
• Dimensiones: 41 x 39,5 x 11 mm		
Alimentación 230V	TRB302B	76,26

TRB302B

Pulsadores IP55

Descripción	Referencia	Precio (€)
1 entrada	TRE301	71,40
2 entradas	TRE302	81,60
• Baterías: 2x CR2430 3V		

TRE301

Mandos a distancia

Descripción	Referencia	Precio (€)
2 entradas	TU402	47,33
4 entradas	TU404	62,73
6 entradas	TU406	78,54
18 entradas	TU418	101,24
• Baterías: 2x CR2430 3V		

TU402

Detectores de movimiento IR

Descripción	Referencia	Precio (€)
Baterías, blanco	TRE520	142,80
Baterías, antracita	TRE521	149,94
Solar, blanco	TRE530	171,36
Solar, antracita	TRE531	179,93

TRE521

Kit detector IR blanco + 1 salida	TRE720	228,13
--	--------	--------

Detectores

Descripción	Referencia	Precio (€)
Detector de apertura	TRC301B	71,40
Detector de luminosidad	TRC321B	81,60

TRC301B

Foco LED con detector

Descripción	Referencia	Precio (€)
Blanco	TRE600	283,34

TRE600

Módulos de salida y entrada/salida

Descripción	Referencia	Precio (€)
ON/OFF, empotrar	TRB201	94,45
ON/OFF, 2 hilos	TRM690G	77,18
• 2 entradas para contactos libres de potencial y 1 salida 200W 230V sin neutro Dimensiones: 40 x 40 x 18 mm		
ON/OFF, 3 hilos	TRM693G	66,12
• 2 entradas para contactos libres de potencial y 1 salida 3A 230V con neutro Dimensiones: 40 x 40 x 20 mm		
Toma comandada ON/OFF	TRC270D	115,46
ON/OFF, IP55	TRE201	116,44
ON/OFF, IP55, con entradas	TRE400	123,73
ON/OFF, IP55, 2 salidas	TRE202	145,55
Regulación, 2 hilos	TRM691E	91,06
• 2 entradas para contactos libre de potencial y 1 salida regulación 200W sin neutro Dimensiones: 40 x 40 x 18 mm		
Persiana	TRM692G	71,97
• 2 entradas para contactos libre de potencial, 1 salida 3A 230V Las entradas están preprogramadas como subida y bajada Dimensiones: 40 x 40 x 20 mm		
Persiana, IP55	TRE221	131,00
Micromódulo multifunción	TRM694G	82,71
• 2 entradas para contactos libre de potencial, 1 salida 4A libre potencial Dimensiones: 40 x 40 x 20 mm		
Micromódulo para telerruptor o temporización	TRM600	84,47
• Genera un contacto impulsional de 200 ms Dimensiones: 40 x 40 x 18 mm		

Válvulas RF

Descripción	Referencia	Precio (€)
Actuador		
Actuador válvulas RF	EK760	113,96
Accesorios		
COMAP M28x 1,5	EK771	17,10
Oventrop M30x1,0	EK772	17,10
Vaillant M28x1,5	EK773	17,10
Herz M28x1,5	EK774	17,10
Giacomini	EK775	19,37

Baterías

Descripción	Referencia	Precio (€)
CR2430 3V	TG401	4,95
1/2AA 3V	TG402	6,63
1/3N 3V	TG403	7,65

TG401

Modo de configuración easy e

Fácil de instalar y de configurar la gama tebis easy le ofrece una alternativa competitiva a la instalación tradicional. Los beneficios que aporta a sus clientes en términos de

confort y de economía de energía hacen que sea una solución que le permitirá desarrollar rápidamente su actividad.



Ventajas:

- Acceso a un nivel de confort sin igual
 - Gestión remota de la instalación
 - Evolución de la configuración
-

Características técnicas:

- Productos KNX
 - Programación easy a través del servidor y la app
-

Más ventajas

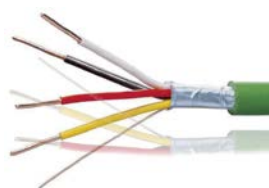

01

easy se basa en el estándar KNX que ofrece:

- evolutividad
- perennidad
- interoperabilidad

02

Configuración simple. Realizada con una herramienta específica intuitiva. Puede realizarse directamente en la obra.

03

Con el bus, el cableado de sus instalaciones se simplifica y evoluciona al ritmo de las decisiones de sus clientes.

04

Funciones de valor añadido para el cliente:

- centralización de comandos
- creación de escenarios
- mando de grupo



05

Integración de domovea. Valóricese su saber hacer proponiendo a sus clientes un interfaz de diseño de visualización acorde con los tiempos actuales.

La manera easy de usar tu hogar inteligente

easy visualización

Una vez todo instalado y configurado sus clientes seguramente querrán escenificar la arquitectura de sus casas o crear diferentes ambientes de luz con simplemente pulsar un botón. Seguramente también querrán controlar de manera segura su propio hogar cuando se encuentren fuera de casa. Pero lo más importante, también desearán ejercer un control adecuado sobre los costes que les permita ahorrar y optimizar su eficiencia y rentabilidad. **domovea permite un control total, una usabilidad óptima y un interfaz atractivo.**

easy gestión

Los nuevos sensores KNX de berker, en sus conocidas líneas de diseño, son el compañero perfecto para los actuadores easy, pero ante todo son su nuevo corazón y cerebro los elementos a destacar. Aquí sus clientes encontrarán siempre la solución adecuada a cada una de sus necesidades -desde interruptores a precios competitivos hasta controladores de estancia o sensores táctiles. **Ajustable y regulable, easy ofrece unos acabados familiares, un control inteligente y una operativa excepcional.**



easy productos

Con los nuevos actuadores easy se pueden utilizar canales binarios multifuncionales además de otros dedicados al control de persianas. En combinación con la nueva estación meteorológica con GPS podrá diseñar múltiples escenarios de confort diferentes. De esta manera aumentaremos el confort disminuyendo al mismo tiempo los costes por iluminación y calefacción.



easy instalación

Los nuevos actuadores easy poseen todas las funciones necesarias para el control íntegro automatizado de su vivienda. Ya sea el simple encendido y apagado de lámparas, la regulación de su intensidad de luz, el accionamiento de persianas, la creación de determinados ambientes luminosos o la adaptación de sus elementos en función del viento y el clima. Todas estas funciones de confort y seguridad están incorporadas en nuestro sistema easy que ofrece **diferentes opciones de instalación, una gama clara de productos y costes reducidos comparado con los actuadores convencionales ETS.**

easy configuración

easy de Hager facilita la configuración intuitiva de sistemas KNX. Usted podrá conectarse sin cables desde su tablet con la herramienta de asistencia easy. A partir de aquí todo funciona de manera automática. Genialmente sencillo.

7 etapas para conseguir

Con el nuevo configurador TXA100, configure de forma simple y fácil sus instalaciones domóticas siguiendo las 7 etapas descritas aquí abajo.

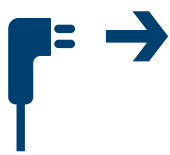

01 Conectar

- Conectar KNX y ethernet (wifi y cable)



02 Encender

- Abrir la aplicación (Easy Tool)
- Crear una instalación nueva o cargue una existente



03 Aprender

- Arrancar el scan de los productos de la instalación
- Personalizar la arquitectura de la instalación



04 Identificar

- Localizar e identificar los productos
- Enumerar, ordenar en los lugares y parametrizar los productos



su configuración

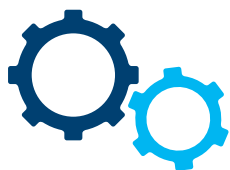

05 Parametrizar

- Crear los enlaces
- Ajustar las regulaciones
- Verificar el buen funcionamiento



06 Guardar

- Exportar el proyecto en una llave USB o en un PC



07 Domovea

- Exportar hacia domovea en local vía una llave USB o directamente en el servidor domovea (si está en la misma red)

Herramienta de configuración easy TXA100

TXA100 le permite parametrizar y testear con toda simplicidad su instalación easy sea cual sea su tipología (bus cable - radio - mixta bus cable y radio). Instale en su tablet, smartphone o PC la aplicación « easy tool » (compatible IOS, Android o Windows). Después, conéctese a la red Wi-Fi integrada al TXA100.

Gracias a esta conectividad, configure y testee la instalación estancia por estancia evitando las pesadas idas y venidas hasta el cuadro eléctrico. TXA100 le permitirá avanzar de manera estructurada en sus proyectos y le hará ganar tiempo en las fases de creación y de ajuste de las funciones.



Ventajas:

- Herramienta de configuración para el profesional
- Móvil, simple de instalar y de utilizar
- Adaptado a las instalaciones por cable y RF
- Generación automática de la visualización domovea para el cliente

Características técnicas:

- Alimentación: 230 V ~ 50 Hz
- Dimensiones: 400 x 330 x 10 mm
- Red Wi-Fi IEEE 802.11 n/g/b
- Bus Ethernet 100/1000 base
- Bus KNX por cable

Kit configurador easy



TXA100

Descripción	Referencia	Precio (€)
Kit configurador easy 1 x conexión bus 1 x conexión RJ45 1 x configurador TJA665 1 x alimentación TXA114 1 x cable ethernet 1 x punto de acceso Wi-Fi	TXA100	599,00

No incluido:
Acoplador de medios TR131



Aplicación "Easy Tool"



TJA665

Servidor KNX easy	TJA665	499,00
--------------------------	--------	---------------

Instalación sencilla

Módulos

TXA

Los módulos easy comparten las mismas características físicas que nuestros actuadores KNX ETS. La diferencia está en cuanto a las funcionalidades.

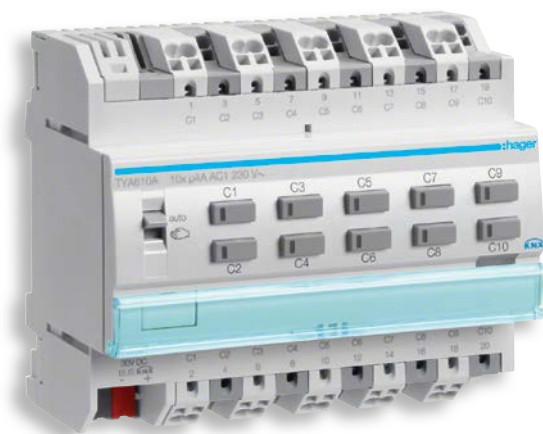

Ventajas:

- Cableado simple
- Visualización directa del estado de las salidas
- Programación easy y ETS
- Amplia gama de funciones

Características técnicas:

- Tecnología **quickconnect**
- Gestión manual frontal
- Un pulsador de mando manual por canal
- Un LED de estado por canal
- Pulsador de programación con LED integrado
- Conmutador automático / manual

Eficacia máxima

Módulos

TXM

Los módulos TXM ofrecen un gran número de salidas en un dispositivo muy compacto, de modo que asegura un

ahorro de espacio en el armario. Su débil consumo, no sobrecargará su instalación KNX.











Ventajas:





- Módulo compacto
- Programación easy y ETS
- Amplia gama de funciones





Características técnicas:

- Mando manual frontal
- Pulsador de programación con LED integrado
- Terminales con tornillo
- Terminales de tornillo PZ1
- Pulsadores para mando local



Funciones generales	Prioridad: Priorización de circuitos > Forzado > Función de base	Programación
Escena	Permite reagrupar un conjunto de salidas pudiendo ser puestas en un estado predefinido programable. Cada salida puede integrarse en 64 escenas diferentes.	 ETS
Forzado	Forzar una salida en un estado definido.	 ETS
Indicación del estado	La función indicación de estado gestiona el estado de cada contacto de salida en el bus KNX.	 ETS
Modo manual	Permite aislar el producto bus. En este modo, es posible forzar localmente cada una de las salidas.	 ETS
Automatismo	Comandar una salida en paralelo, con la función ON/OFF para la iluminación o la función subida/bajada/inclinación/paro de las lamas para las persianas/toldos.	 ETS

 Iluminación	Prioridad: Modo manual > Priorización de los estados > Forzado > Función de base	
ON/OFF	Encender o apagar un circuito de iluminación.	 ETS
Minutero	Encender o apagar un circuito de iluminación con una duración parametrizable Un preaviso de extinción parametrizable señala el fin de la temporización por una inversión del estado de la salida durante 1s.	 ETS
Priorización de los estados	Para el forzado de una salida en OFF.	 ETS

 Regulación	Prioridad: Modo manual > Priorización de los estados > Forzado > Función de base	
ON/OFF	Encender o apagar un circuito de iluminación.	 ETS
Variación relativa o absoluta	Aumentar o disminuir progresivamente el nivel de iluminación en función de un valor de iluminación.	 ETS
Minutero	Encender o apagar un circuito de iluminación con una duración parametrizable.	 ETS
Priorización de los estados	Para el forzado de una salida en OFF.	 ETS

 Persianas	Prioridad: Modo manual > Priorización de los estados > Forzado > Función de base	
Subida/bajada	Permite subir y bajar una persiana, un estor de lamas inclinables, un toldo, un estor veneciano, etc...	 ETS
Stop	Permite parar el curso de una persiana o toldo.	 ETS
Inclinación de las lamas/ Stop	Permite inclinar las lamas de una persiana o de parar su movimiento en curso. Esta función permite modificar la ocultación o redirigir los rayos luminosos que provienen del exterior.	 ETS
Alarma	Poner una persiana o toldo en un estado predefinido parametrizable. Es posible parametrizar hasta 3 alarmas.	 ETS



Módulos de salida easy

	Descripción	Referencia	Precio (€)
	1 salida empotrar, 10A, easy	TXB601B	62,00
	2 salidas empotrar, 6A, easy	TXB602F	80,00
TXA604D	4 salidas, 16A cargas capacitivas, easy	TXA604D	245,70
	6 salidas, 10A, easy	TXA606B	228,90
	6 salidas, 16A, easy	TXA606D	270,90
	8 salidas, 10A, easy	TXA608B	277,20
TXA604D	8 salidas, 16A cargas capacitivas, easy	TXA608D	311,85
	10 salidas, 10A, easy	TXA610B	333,90
	10 salidas, 16A cargas capacitivas, easy	TXA610D	375,90
	16 salidas, easy	TXM616D	535,00
TXM616D	<ul style="list-style-type: none"> Módulo mixto ON/OFF, persianas 8 Módulos 		
	20 salidas, easy	TXM620D	600,00
	<ul style="list-style-type: none"> Módulo mixto ON/OFF, persianas 10 Módulos 		

Módulos de regulación easy

	Descripción	Referencia	Precio (€)
	1 canal 300W, easy	TXA661A	139,65
	1 canal 600W, easy	TXA661B	187,95
	2 canales 300W, easy	TXA662AN	260,00
	3 canales 300W, easy	TXA663A	346,50
TXA661A	4 canales 300 W, easy	TXA664AN	420,00

Módulos de persiana easy

	Descripción	Referencia	Precio (€)
	2 entradas + 1 salida persianas, easy	TXB692F	92,61
	4 estores / persianas 230 V, easy	TXA624C	208,95
TXB692F	4 estores / persianas 24 V, easy	TXA624D	243,60
	8 estores / persianas 230 V, easy	TXA628C	370,65
	12 persianas, easy	TXM632C	535,00
	<ul style="list-style-type: none"> 10 Módulos 		

Estación meteorológica easy

	Descripción	Referencia	Precio (€)
NUEVO	Estación meteorológica KNX easy	TXE531	649,00



TXE531

Accesorios

Puentes de unión

	Descripción	Referencia	Precio (€)
	6 mm ² , 8 contactos	TGM616D	11,26
	<ul style="list-style-type: none"> Diseñado para ref. TXM616D Incluye 2 piezas y 4 topes In: 16A 		

	6 mm ² , 10 contactos	TGM620D	15,16
	<ul style="list-style-type: none"> Diseñado para ref. TXM620D Incluye 2 piezas y 4 topes In: 16A 		

TGM620D

	Tops para puentes de unión TGM6XXX	TGM600E	8,23
	<ul style="list-style-type: none"> Diseñado para ref. TGM616D y TGM620D Incluye 10 pares 		

TGM600E

Nota: para completar la instalación easy, ver páginas de la 237 a la 241 Referencias marcadas con el símbolo 

Modo de configuración ETS

Los actuadores modulares KNX de Hager han (con)vencido durante los últimos años: el hardware nos ha conquistado gracias a un diseño compacto y atractivo, con una

ergonomía adecuada a una manipulación precisa. Uso más cómodo, más facilidad a la hora de trabajar.



Ventajas:

- Nuevas aplicaciones ETS repletas de novedosas funcionalidades
- Tiempo de descarga reducido debido a la instalación de complementos
- Diseño moderno y compacto
- Conexiones rápidas mediante bornes sin tornillos
- Control manual de las salidas en el producto
- Dispositivo de señalización de estado para cada canal
- Porta-etiquetas para identificar los productos/canales

Características técnicas:

- Actuadores binarios con 4, 6, 8 y 10 canales de 4 A, 10 A, 16 A y 16 A para cargas capacitivas
- Actuador binario con 6 canales de 16 A para cargas capacitivas con medición de corriente
- Regulador universal con 300 W, 600 W o 3 x 300 W, para control de bombillas fluorescentes compactas y LED regulables
- Actuadores de estores/persianas con 4 y 8 canales para motores 230 V o 24 V CC
- Actuadores binarios para empotrar con 1 y 2 canales
- Actuador de estores para empotrar de 1 canal para motores 230V

Más ventajas



01

Estándar internacional
La oferta Hager se basa en el estándar KNX que ofrece:
- evolutividad
- perennidad
- interoperabilidad

03

Más allá de su forma primaria, cada producto de la gama KNX participa en la optimización de la eficiencia y eficacia global de la instalación.



02

Configuración simple.
Realizada con una herramienta específica (ETS) desde un PC.

04

Las aplicaciones ETS de los productos tebis han sido rediseñados para permitirles ganar tiempo en la configuración.

Módulos TYA

Los módulos TYA comparten las mismas características técnicas que los módulos TXA, mientras que a nivel de funciones son mucho más potentes.

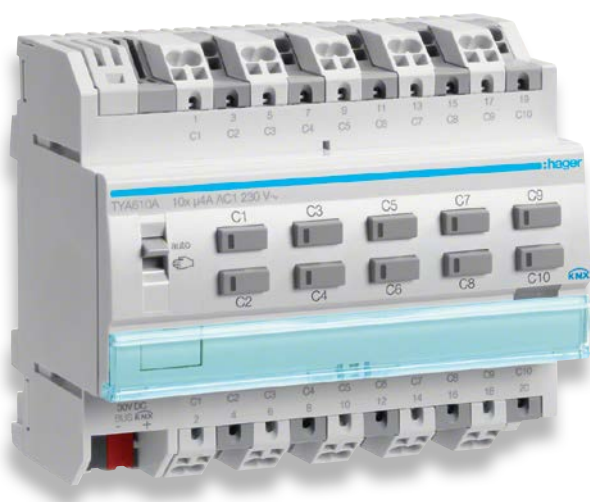

Ventajas:

- Cableado simple
- Visualización directa del estado de las salidas
- Programación ETS
- Amplia gama de funciones

Características técnicas:

- Tecnología quickconnect 
- Mando manual frontal
- Un pulsador por canal
- Un LED de estado por canal
- Pulsador de programación con LED integrado
- Conmutador automático / manual

Funciones generales	Prioridad: Priorización de circuitos > Forzado > Función de base	Programación
Escena	Permite reagrupar un conjunto de salidas pudiendo ser puestas en un estado predefinido programable. Cada salida puede integrarse en 64 escenas diferentes.	ETS
Preset	Poner un conjunto de salidas en un estado predefinido parametrizable.	ETS
Forzado	Forzar una salida en un estado definido.	ETS
Indicación de estado avanzado	El comportamiento de la indicación del estado para cada salida para puede ser parametrizada por el conjunto del producto.	ETS
Modo manual	Permite aislar el producto bus. En este modo, es posible forzar localmente cada una de las salidas.	ETS
Bloque lógico	El mando de una salida según el resultado de una operación lógica.	ETS
Diagnóstico producto	Señalar el estado de funcionamiento de la apartamenta vía bus KNX. Esta información se emite periódicamente y/o sobre el cambio de estado.	ETS
Bloqueo	La función bloqueo permite bloquear una salida en un estado predefinido.	ETS
Desactivación LED	Los LEDs de los módulos pueden desactivarse	

Iluminación
Prioridad: Modo manual > Priorización de los estados > Forzado > Función de base

ON/OFF	Encender o apagar un circuito de iluminación.	
Minutero	Encender o apagar un circuito de iluminación para una duración parametrizable Un preaviso de extinción parametrizable señala el fin de la temporización por una inversión del estado de la salida durante 1s.	ETS
Telerruptor temporizado	La función telerruptor minutero permite realizar un telerruptor con una temporización de extinción parametrizable (anti-olvido).	ETS
Minutero/telerruptor	La función minutero/ telerruptor permite la commutación entre un modo telerruptor y un modo minutero sobre un mismo objeto de mando.	ETS
Contador de horas	Contabilizar la duración acumulada en ON o OFF de una salida	

Regulación
Prioridad: Bloqueo integral > modo manual > Alarma > Forzado > Bloqueo > Función de base
Mismas funciones que la iluminación y además:

Variación relativa o absoluta	Aumentar o disminuir progresivamente el nivel de iluminación en función de un valor de iluminación	ETS
Modo experto, elección del modo de variación	El modo de variación para cada salida puede ser regulada en modo expert , sea localmente en el frontal del producto, sea a través del parámetro modo de variación en ETS.	

Persianas
Prioridad: Modo manual > Priorización de los estados > Forzado > Función de base

Subida/bajada	Permite subir y bajar una persiana, un estor de lamas inclinables, un toldo, un estor veneciano, etc...	ETS
Stop	Permite parar el curso de una persiana o toldo.	ETS
Inclinación de las lamas/ Stop	Permite inclinar las lamas de una persiana o de parar su movimiento en curso. Esta función permite modificar la ocultación o redirigir los rayos luminosos que provienen del exterior.	ETS
Alarma	Poner una persiana o toldo en un estado predefinido parametrizable. Es posible de parametrizar hasta 3 alarmas. Prioridad: Alarma > Forzado > Función de base	ETS
Bloqueo integral	Esta función permite definir el estado de todas las salidas del aparato con la prioridad más elevada. Todos los otros modos, incluido el modo manual, no se tienen en cuenta.	ETS
Seguimiento solar	Generar la luminosidad de una habitación en función de la luminosidad exterior (TG053A)	ETS
Indicación de estado avanzado	Indicación posición en %: indica la posición de la persiana o del toldo. Indic. posición lamas en %: indica la inclinación del toldo. Posición alcance alto o bajo: indica la llegada a la posición alta o baja.	ETS

Fuentes de alimentación sistema



TXA114

Descripción	Referencia	Precio (€)
320 mA	TXA111	263,16
640 mA	TXA112	326,60
30V DC, 320 mA + 24V DC, 640mA	TXA114	340,22
2x30V DC, 320mA	TXA116	414,65

Cable EIB-Y (ST) Y x 2 x 2 x 0,8 mm



TG018

Descripción	Referencia	Precio (€)
100 m	TG018	101,90
500 m	TG019	489,83
Sin halógenos, 100 m	TG060	269,99
Sin halógenos, 500 m	TG061	1.349,97

- Aislado 4kV

Fuentes de alimentación auxiliares



TP110

Descripción	Referencia	Precio (€)
24V, DC, empotrar	TP110	107,30
<ul style="list-style-type: none"> • Para estación meteorológica 		
24V, DC	TGA200	183,70
<ul style="list-style-type: none"> • Para servidor domovea 		
24V AC	ST312	consultar
<ul style="list-style-type: none"> • Para router IP, entradas analógicas,... • Familia 40 • Tarifa 915 o posteriores 		

Bornes de conexión bus



TG008

Descripción	Referencia	Precio (€)
Rojo/negro	TG008	1,19
Amarillo/blanco	TG025	1,19

- Embalaje: 50

Puentes de conexión



TG200A

Descripción	Referencia	Precio (€)
Negro	TG200A	28,76
Gris	TG200B	28,76
Marrón	TG200C	28,76

Componentes del sistema



TR131A

Descripción	Referencia	Precio (€)
Acoplador de línea	TYF130	371,48
Interface modular USB/KNX	TH101	241,13
Cable USB para TH101	TH103	20,64
Acoplador de medios, blanco	TR131A	219,10
Acoplador de medios, plata	TR131B	225,72
Repetidor radio, blanco	TR140A	213,28
Repetidor radio, plata	TR140B	219,61
Concentrador de entradas	TR351A	174,93
Limitador de sobretensión	TG029	64,77
Router IP KNX	TH210	606,80
• Alimentación externa 24V AC		
Pasarela IP KNX	TYF120	250,00
Pasarela EnOcean/KNX	TYC120	459,00

Módulos de entrada empotrar



TXB302

Descripción	Referencia	Precio (€)
2 entradas libres de potencial	TXB302	57,94
4 entradas libres de potencial	TXB304	105,57
2 entradas de empotrar + 2 salidas LED	TXB322	59,67
4 entradas de empotrar + 4 salidas LED	TXB344	108,73
Kit de 4 LED rojos	TG308	8,77
8 entradas libres de potencial	TYB708D	123,00

Módulos de entrada carril DIN



TXA304

Descripción	Referencia	Precio (€)
4 entradas, 230V	TXA304	180,44
6 entradas universales: libre potencial, 24/230V AC/DC	TXA306	317,12
10 entradas, 230V	TXA310	431,77

Módulos de entradas analógicas



TYF784

Descripción	Referencia	Precio (€)
4 entradas	TYF784	275,40
Extensión 4 entradas	TYF784E(*)	224,40

(*) necesita de un TYF784
• Alimentación externa 24V AC

Módulos de salida

1 salida, empotrar



TYB601B

Descripción	Referencia	Precio (€)
Empotrar 10A 230V AC1	TYB601B	91,71

2 salidas, empotrar



TYB602F

Descripción	Referencia	Precio (€)
Empotrar 6A 230V AC1	TYB602F	108,12

4 salidas



TYA604D

Descripción	Referencia	Precio (€)
4A AC1	TYA604A	231,72
10A AC1	TYA604B	278,09
16A AC1	TYA604C	370,71
16A AC1 cargas capacitivas	TYA604D	383,55

6 salidas



TYA606E

Descripción	Referencia	Precio (€)
4A AC1	TYA606A	322,00
10A AC1	TYA606B	362,25
16A AC1	TYA606C	396,80
16A AC1 cargas capacitivas	TYA606D	409,84
16A monotorización intensidad	TYA606E	437,66

8 salidas



TYA608A

Descripción	Referencia	Precio (€)
4A AC1	TYA608A	395,88
10A AC1	TYA608B	433,48
16A AC1	TYA608C	475,00
16A AC1 cargas capacitivas	TYA608D	498,29

10 salidas



TYA610A

Descripción	Referencia	Precio (€)
4A AC1	TYA610A	478,22
10A AC1	TYA610B	514,70
16A AC1	TYA610C	569,32
16A AC1 cargas capacitivas	TYA610D	588,57

- Recomendación: evitar el uso con 5 persianas

Módulos de regulación



1 canal

Descripción	Referencia	Precio (€)
20 a 300 W/VA	TYA661AN	217,86
20 a 600W/VA	TYA661BN	294,59

TYA661AN

NUEVO

2 canales



Descripción	Referencia	Precio (€)
300 W	TYA662AN	390,00

TYA662AN

3 canales



Descripción	Referencia	Precio (€)
300 W/VA	TYA663AN	538,34

TYA663AN

- 3 posiciones: 3 salidas de 300 W / 1 salida de 300 W y otra de 600 W / 1 salida de 900W

NUEVO

4 canales



Descripción	Referencia	Precio (€)
4 x 300 W/VA	TYA664AN	575,50
4 x 600 W/VA	TYA664BN	690,60

TYA664AN

Módulos de regulación 1/10 V



Descripción	Referencia	Precio (€)
3 canales	TX211A	307,12

TX211A

Módulos RGB LED



Descripción	Referencia	Precio (€)
Controlador LED, 3 canales. Controlado por tensión	TYB673A	251,20

TYB673A

Descripción	Referencia	Precio (€)
Controlador LED, 3 canales. Controlado por intensidad	TYB673B	266,30

- Alimentación externa 12-24V D.C.

Pasarela DALI



Descripción	Referencia	Precio (€)
Pasarela DALI	TYA670D	570,00

Módulos de persianas



Persianas

Descripción	Referencia	Precio (€)
1 salida, empotrar	TYB692F	119,53

TYB692F

Persianas enrollables



Descripción	Referencia	Precio (€)
4 motores 230V AC 6A	TYA624A	271,05
4 motores 24V, DC, 6A	TYA624B	279,41

TYA624A

Descripción	Referencia	Precio (€)
8 motores 230V	TYA628A	478,22



Persianas de lamass

Descripción	Referencia	Precio (€)
4 motores 230V AC 6A	TYA624C	342,79
4 motores 24V, DC, 6A	TYA624D	359,61

TYA624C

Descripción	Referencia	Precio (€)
8 motores 230V	TYA628C	594,48

Módulos de salidas analógicas



Descripción	Referencia	Precio (€)
4 salidas	TYF684	397,80
Extensión 4 salidas	TYF684E(*)	346,80

TYF684

(*) necesita de un TYF684

Actuador estancia



Descripción	Referencia	Precio (€)
4/2 salidas + 2 para válvulas electrotérmicas	TYF646M	385,00

TYF684

Módulos de calefacción



TX320

Termostato de ambiente

Descripción	Referencia	Precio (€)
Blanco	TX320	181,46



TX501

Actuadores de válvula

Descripción	Referencia	Precio (€)
Continua	TX501	230,21
Continua con temperatura	TX502	329,05



TYB641A

Salida de calefacción

Descripción	Referencia	Precio (€)
Válvulas térmicas (x6)	TX206H	481,03
6 salidas, triac, 230V	TYF656T	255,00
Fancoil, 2 canales	TYF642F	326,40

Interruptor horario



TXA022

Interruptor horario

Descripción	Referencia	Precio (€)
Semanal: 7 días, 2 canales	TXA022	214,81
Annual	TYA720	410,00
Antena DCF para TYA720	EG001	130,00



EG004

Llaves

Descripción	Referencia	Precio (€)
De bloqueo	EG004	consultar
De programación	EG005	consultar

• familia 40



EG003U

Interface de programación

Descripción	Referencia	Precio (€)
Para llaves	EG003U	consultar

• familia 40

Estación meteorológica



TG053A

KNX GPS

Descripción	Referencia	Precio (€)
KNX GPS	TG053A	997,25



TG353

Accesorios

Descripción	Referencia	Precio (€)
Brazo articulado grande	TG353	73,04
Brazo articulado pequeño	TG354	37,92

Interruptor crepuscular



TXA025

Interruptor crepuscular

Descripción	Referencia	Precio (€)
Interruptor crepuscular	TXA025	208,39



EEN002

Célula

Descripción	Referencia	Precio (€)
Empotrar	EEN002	consultar
Superficie	EEN003	consultar

• familia 40

Detectores de presencia



TXC511

Detectores de presencia 360°

Descripción	Referencia	Precio (€)
2 canales	TX510	234,80
1 canal regulación	TXC511	271,22



EE813

Caja de superficie

Descripción	Referencia	Precio (€)
Caja de superficie	EE813	consultar

• Familia 40



TCC510S

Detectores de presencia 360° monobloc

Descripción	Referencia	Precio (€)
Con relé integrado	TCC520E	213,18
DALI	TCC521E	256,94
Básico	TCC510S	163,20
Multicanal	TCC530E	214,20



EE807

Mandos a distancia

Descripción	Referencia	Precio (€)
Instalador	EE807	51,98
Usuario	EE808	41,80

Detectores vía radio



TG510A

Humo

Descripción	Referencia	Precio (€)
6V DC	TG510A	102,31
230V AC	TG511A	125,26



TG540A

Térmico

Descripción	Referencia	Precio (€)
6V DC	TG540A	110,26
230V AC	TG541A	131,38

Contadores de energía



TE331

Monofásico

Descripción	Referencia	Precio (€)
Indicador consumo (no incluye TI)	TE331	140,00
Indicador consumo (incluye TI - 3 x EK028)	TE332	195,00

Sonda de temperatura exterior	EK088(*)	46,31
Sonda de temperatura interior	EK089(*)	35,00

Transformador de intensidad 1850-1A	EK028	20,00
--	-------	--------------

(*) para TE33x



TE360

Trifásico

Descripción	Referencia	Precio (€)
100 A	TE360	417,38
6.000 A	TE370*	406,57

(*) Conexión mediante TI con 5A en el secundario

Pasarela de pulsos

NUEVO



TXE771

Descripción	Referencia	Precio (€)
1 canal	TXE771	102,56
3 canales	TXE773	170,94

domovea

domovea tebis es el software de gestión y visualización diseñado por Hager para las instalaciones KNX tebis. Permite acceder al conjunto de funcionalidades domóticas de la instalación desde los interfaces de cliente conectados en red: PC, pantallas táctiles, smartphones, iPhone... Se trata de una de las soluciones de visualización más sencillas de configurar, desarrollada en colaboración con

Microsoft. domovea es totalmente compatible con Windows®, por lo que el sistema domótico puede gestionarse desde cualquier interfaz compatible.

Disponible también la aplicación para iOS y Android que permite la gestión de la instalación tanto en local como en remoto desde el terminal.



Ventajas:

- Solución de visualización fácil de configurar
 - Compatible easy y ETS
-

Características técnicas:

- Arquitectura mono o multi-puesto
 - Producto modular y evolutivo
 - Acceso a distancia seguro con el portal www.domovea.com
 - Gestión de funciones lógicas a través de secuencias
-

Más ventajas



01

Un interfaz ergonómico. domovea propone un interfaz de mando permitiendo navegar en la instalación domótica fácilmente.

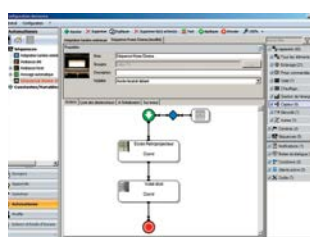

02

La función super escenario acciona funcionalidades: - secuenciándolas en el tiempo o en función de bloques lógicos parametrizables.



03

Cámaras IP. domovea le permite gestionar una lista de cámaras IP y de hacerlas interactuar con la instalación.



04

El portal seguro www.domovea.com le permite acceder a su instalación vía internet.



05

Domovea permite visualizar el consumo eléctrico global, los subconsumos, la producción de electricidad en forma de histograma o de tacómetro. El consumo se indica en kW / h y en €.



06

App para iOS y Android
La aplicación permite realizar la gestión local y remota, mostrar cámaras y realizar capturas, gestionar secuencias o modificar el homestatus.

domovea



TJA451

Descripción	Referencia	Precio (€)
Kit servidor domovea + fuente + acceso remoto	TJA451	1.275,00



TJA450

Descripción	Referencia	Precio (€)
Servidor domovea con acceso remoto incluido	TJA450	1.150,00



domovea App.

Controlador IoT

NUEVO



TJA560

Descripción	Referencia	Precio (€)
Controlador IoT	TJA560	704,00

- Alimentación externa 24V vía: TGA200 o TXA114
- Consultar disponibilidad



Hager IoT App

Pantallas táctiles

Las nuevas pantallas táctiles están disponibles en 2 versiones: Android y Windows. Estos productos son los interfaces gráficos entre la instalación KNX y el servidor domovea.

Instalando estos dos tipos de pantalla en sus cajas de empotrar adecuadas, ofrecen una solución perfectamente integrada.

Características

- WDI070: 16:9, procesador ARM 1 GHz 8 GB de memoria

- WDI100: 16:9, procesador ARM 1 GHz 8 GB de memoria

- WDI101: 16:9, procesador AMD doble núcleo 2 x 1 GHz, radeon HD6320, 2 GB DDR3 64 GB SSD

- WDI161: 16:9, procesador AMD doble núcleo 2 x 1 GHz, radeon HD6320, 2 GB DDR3 32 GB SSD

Pantalla táctil

- Tecnología capacitiva
- Micro y altavoz
- Alimentación 24 V DC (TGA 200)



Touch panel Android

WDI070

Descripción	Referencia	Precio (€)
7" - 800 x 480	WDI070	1.260,00
10" - 1280 x 800	WDI100	1.690,00

- Sin acceso a Play Store



Touch panel Windows

WDI100

Descripción	Referencia	Precio (€)
10" - 1280 x 800	WDI101	3.455,00
16" - 1366 x 768	WDI161	3.750,00

Caja para pantalla táctil



WDW070

Cajas de empotrar (sobresale)

Descripción	Referencia	Precio (€)
Para WDI070	WDW070	80,00
Para WDI10X	WDW100	95,00
Para WDI161	WDW160	110,00

Cajas de empotrar alineada

Descripción	Referencia	Precio (€)
Para WDI070	WDW071	160,00
Para WDI10X	WDW101	190,00
Para WDI161	WDW161	250,00

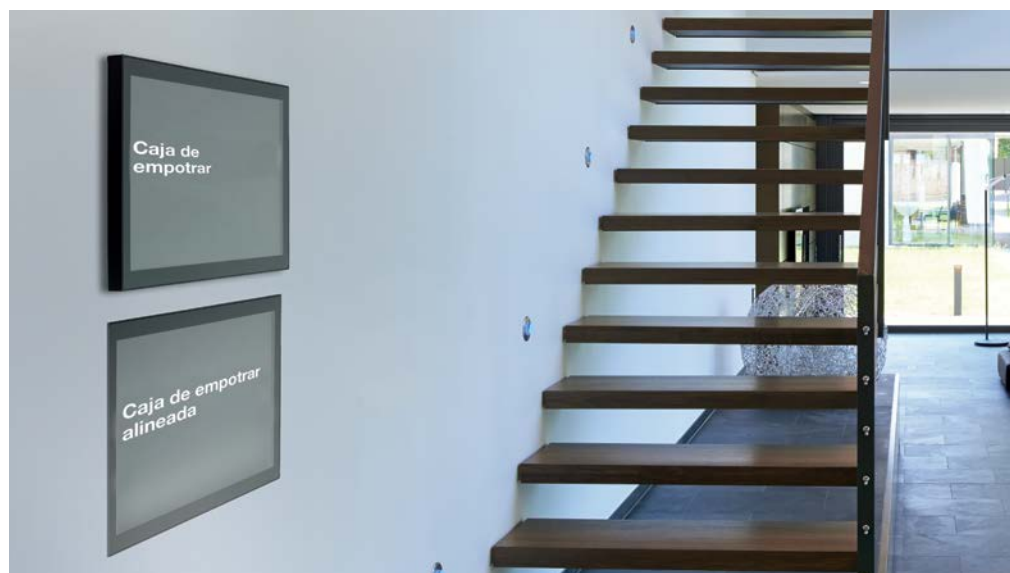

En la fotografía de la izquierda se puede apreciar la diferencia entre la pantalla con la caja de empotrar y la caja de empotrar alineada.

Guía técnica

Guía técnica

pág.

instrucciones de limpieza y cuidado	248
lumina 2	250
estancas IP44	252
medidas series berker	253
cubyko IP55	260
configuración de productos tebis.quicklink	264
actuadores KNX	266
certificados de productos y símbolos	281
materiales y colores RAL	282

Instrucciones de limpieza y cuidado

Para la limpieza de las superficies utilizar un paño húmedo, suave, sin hilos.

En caso de mucha suciedad recomendamos el uso de un agente limpiador doméstico diluido que contenga jabón. Las superficies de cristal y aluminio pueden limpiarse con limpiadores comunes de cristal.

Si hay mucha suciedad en superficies de acero, es preferible utilizar limpiadores específicos. Por favor, tenga en cuenta las instrucciones de uso ya que pueden ser productos no aptos para las partes plásticas.

Los detergentes abrasivos y abrillantadores con base ácida y los detergentes que contienen cloro dañan normalmente todas las superficies. Las superficies pintadas/lacadas no deben ponerse en contacto con detergentes que contengan alcohol.



Interrupor
WL001X

Conmutador
WL002X

Cruzamiento
WL003X

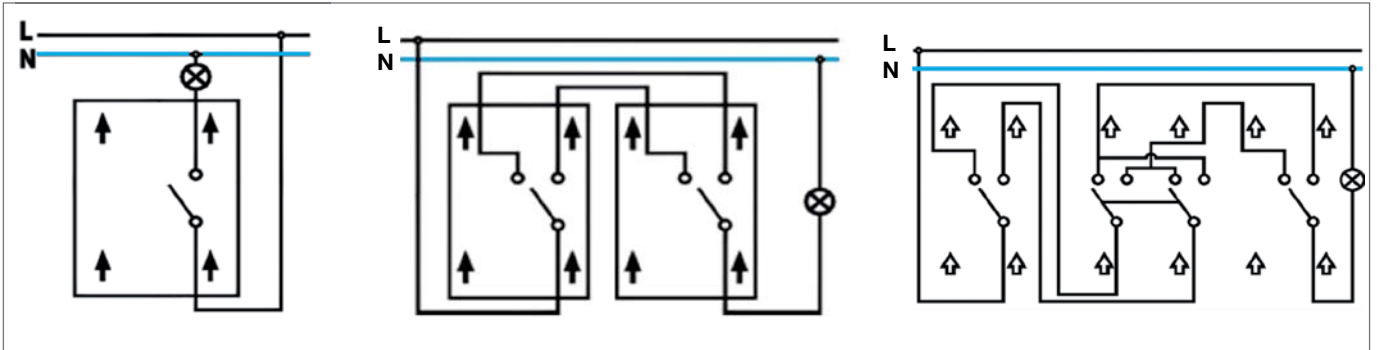

Interrupor doble
WL004X

Conmutador doble
WL005X

Interrupor bipolar
WL006X

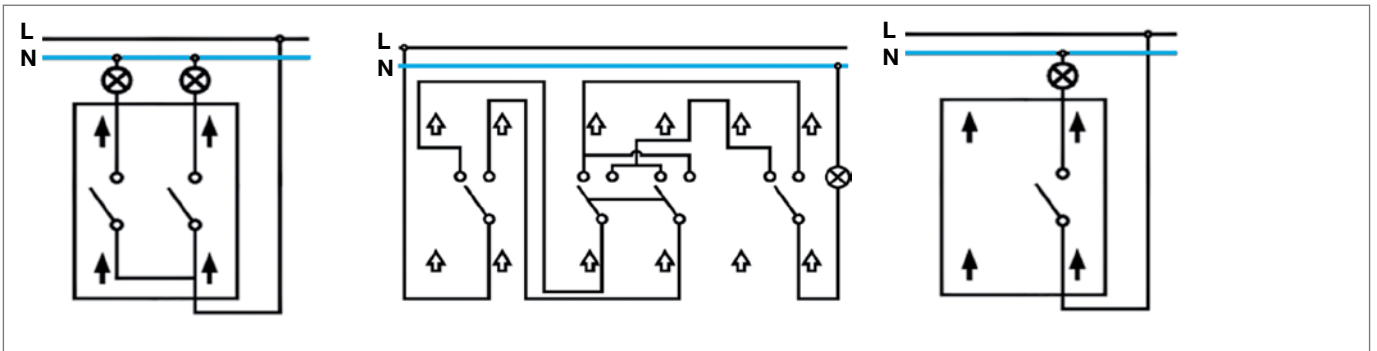

Interrupor triple
WL007X

Pulsador
WL011X

Interrupor con indicador luminoso
WL021X

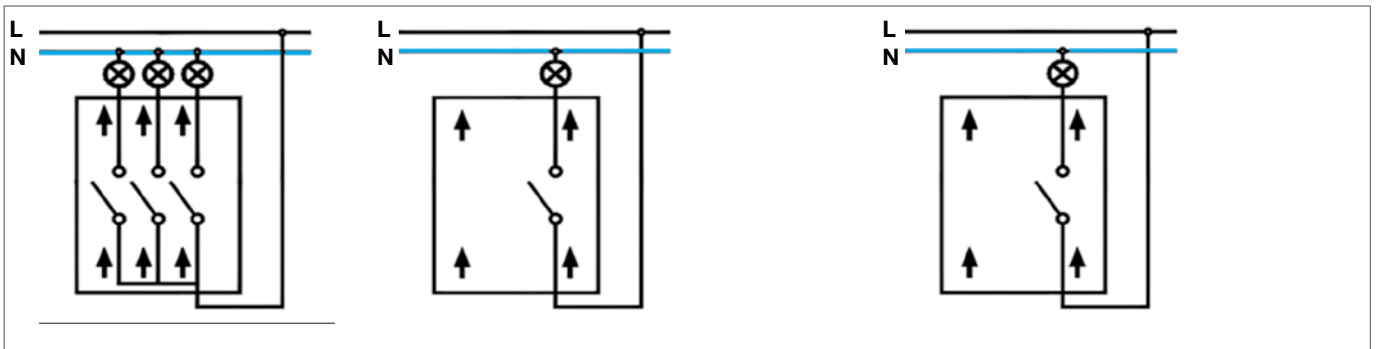

Conmutador con
indicador luminoso
WL022x

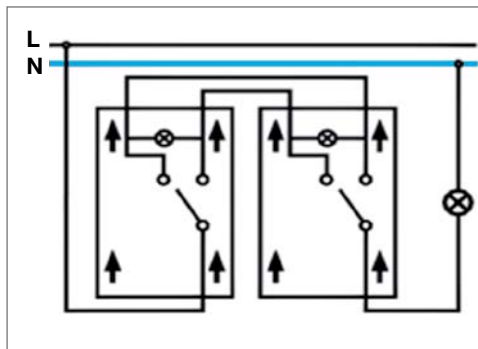

Interruptor doble
con indicador luminoso
WL024X

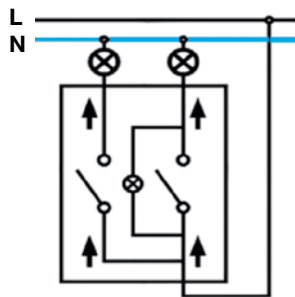

Interruptor para persiana
WL031X

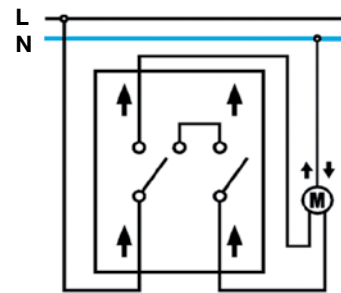

Pulsador
para persiana
WL032X

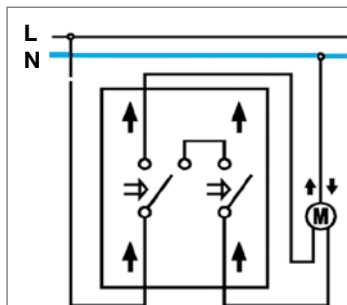

Regulador rotativo
WL401X /403X

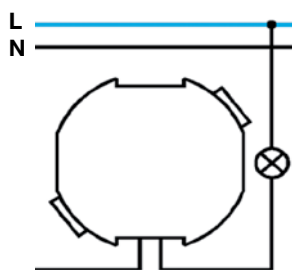

Dimensiones

Marco: 80 x 80 mm

Colores

Blanco Polar: RAL 9016

Blanco: RAL 9001

berker Q.1/ Q.3 / K.1/ K.5 IP44

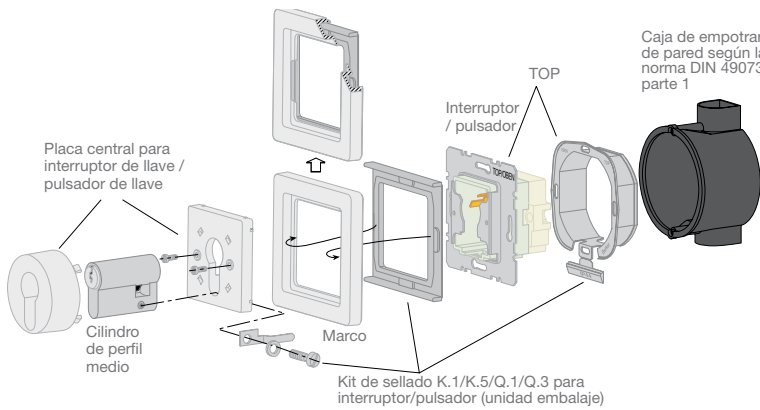
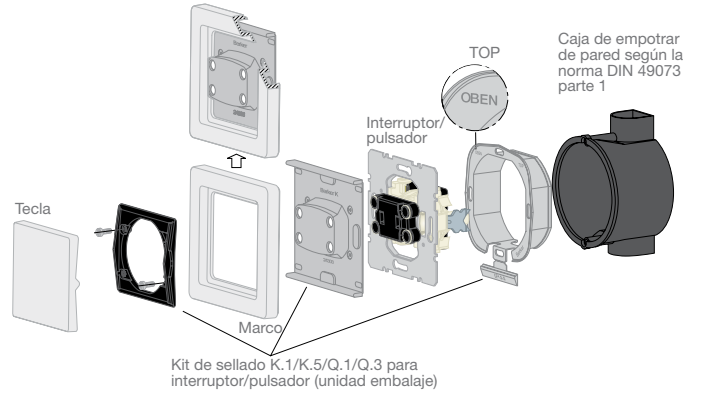
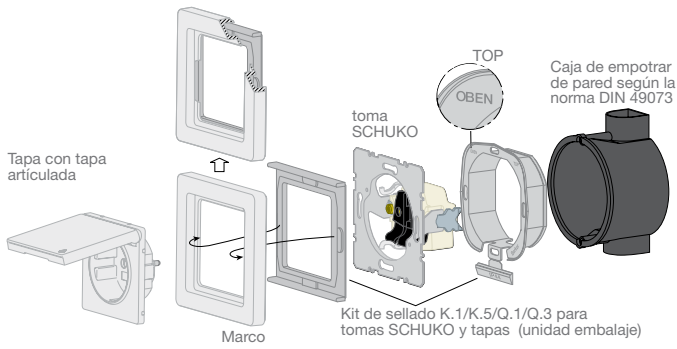

La protección IP44 es también compatible con los productos marcados con un  en este catálogo. En esta página les mostramos a que gamas pertenecen. La protección IP44 sólo puede asegurarse en estas gamas usando el kit de sellado pertinente.

berker Q.1 / Q.3

berker Q.1/Q.3
pág. 88 a 94



berker K.1 / K.5

berker K.1 / K.5
pág. 102 a 105



berker R.1 / R.3

berker R.1 / R.3
pág. 126 a 131



berker R.1 / R.3 IP44

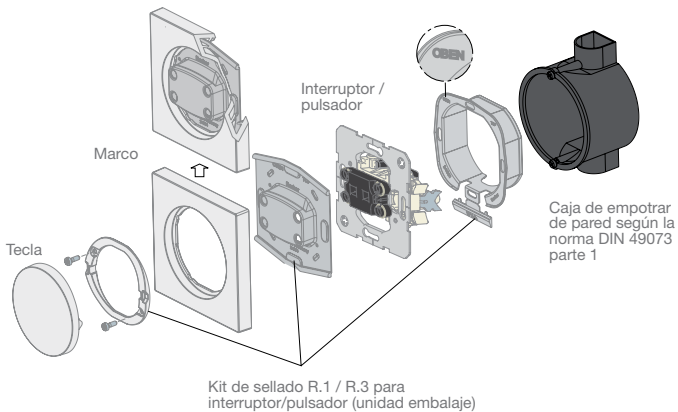
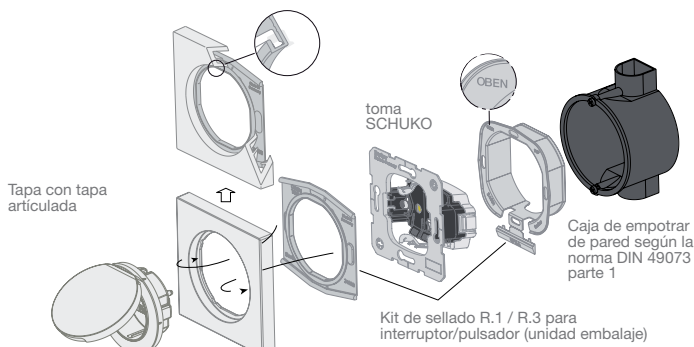

berker S.1

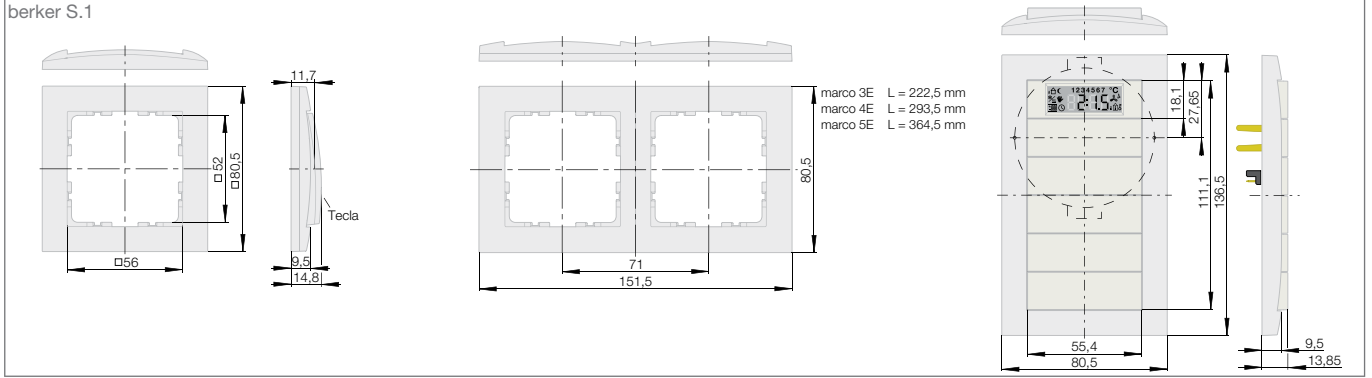

berker B.3

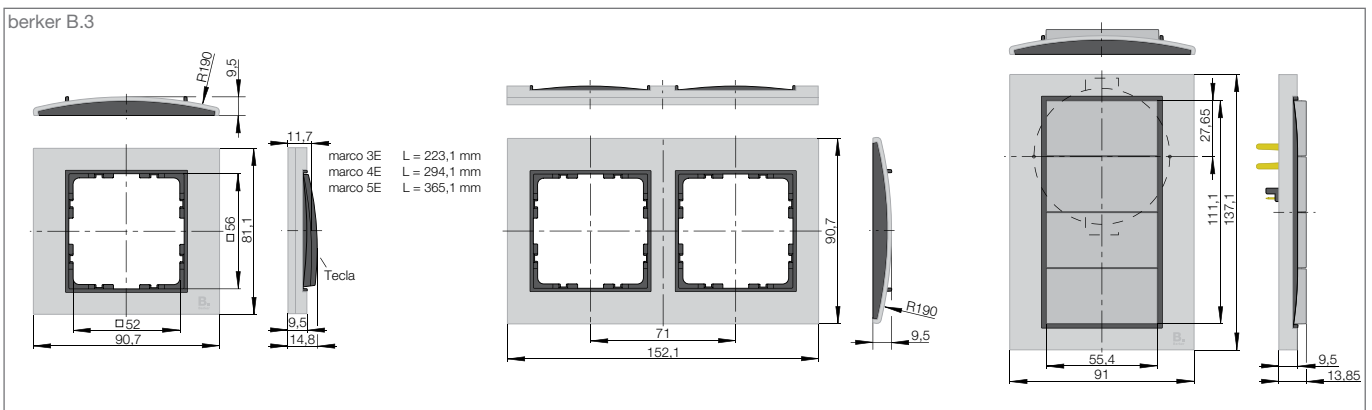

berker B.7 Glas

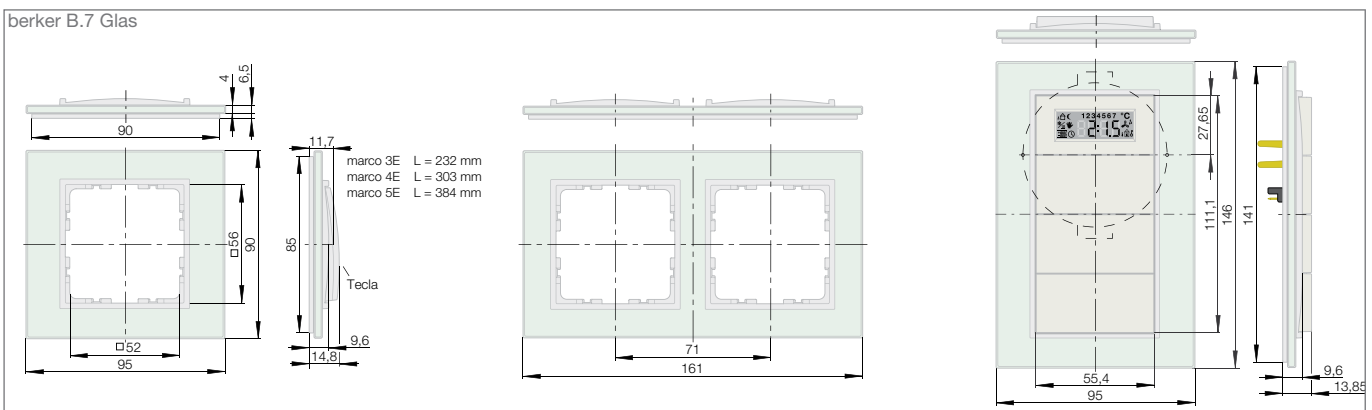

berker Q.1

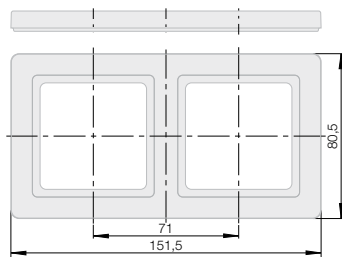
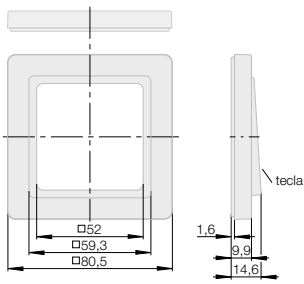

marco 3E L = 222,5 mm
marco 4E L = 293,5 mm
marco 5E L = 364,5 mm

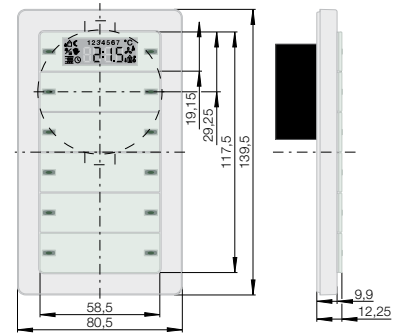

berker Q.3

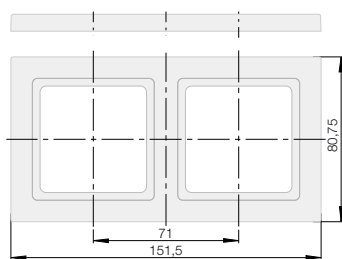
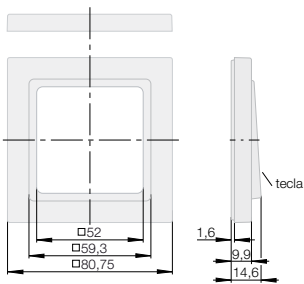

marco 3E L = 222,5 mm
marco 4E L = 293,5 mm
marco 5E L = 364,5 mm

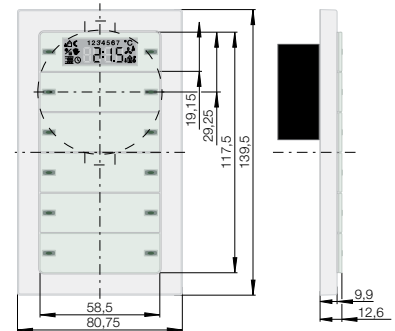

berker K.1 / K.5

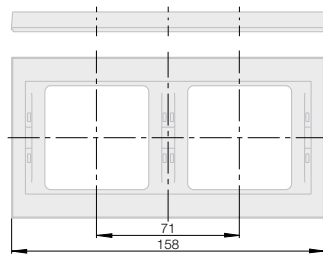
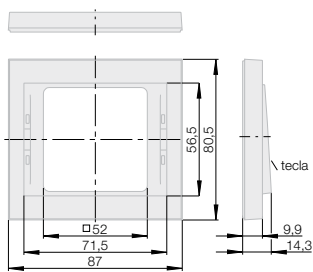

marco 3E L = 229 mm
marco 4E L = 300 mm
marco 5E L = 371 mm

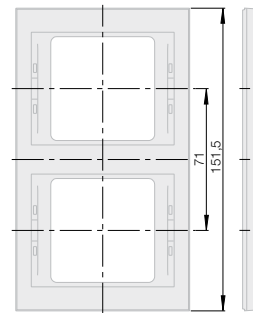

marco 3E L = 222,5 mm
marco 4E L = 293,5 mm
marco 5E L = 364,5 mm

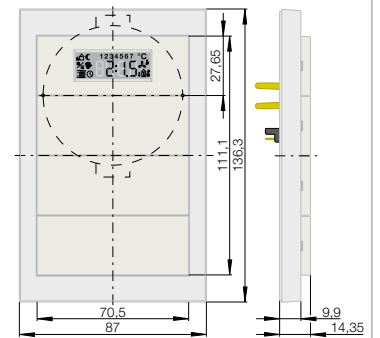

berker Arslys

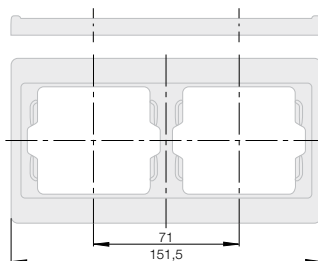
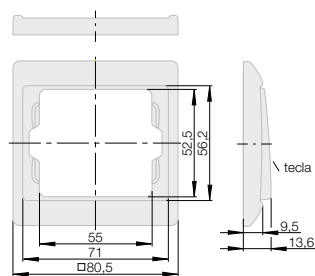

marco 3E L = 222,5 mm
marco 4E L = 293,5 mm
marco 5E L = 364,5 mm

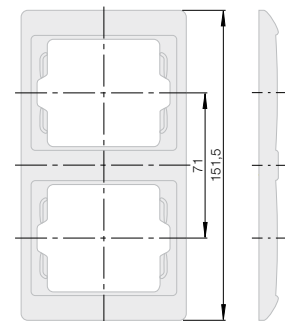

berker R.1

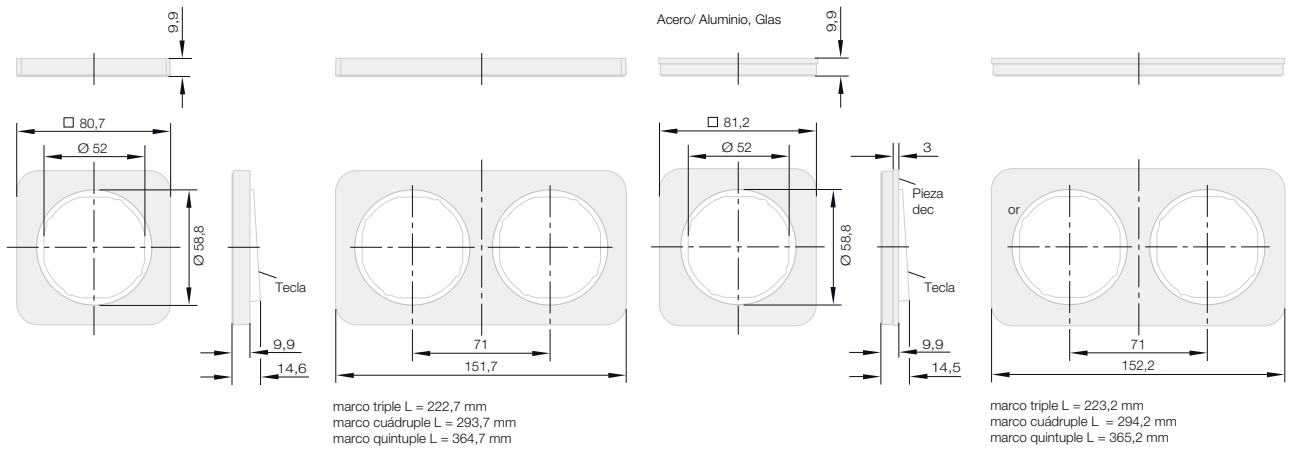

berker R.1 - Touch Sensor

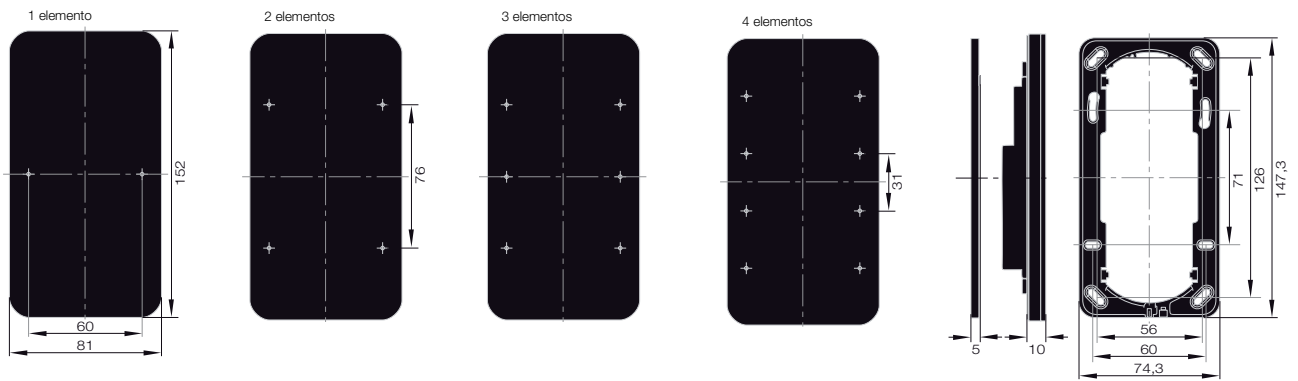

berker R.1 - Touch Sensor con termostato

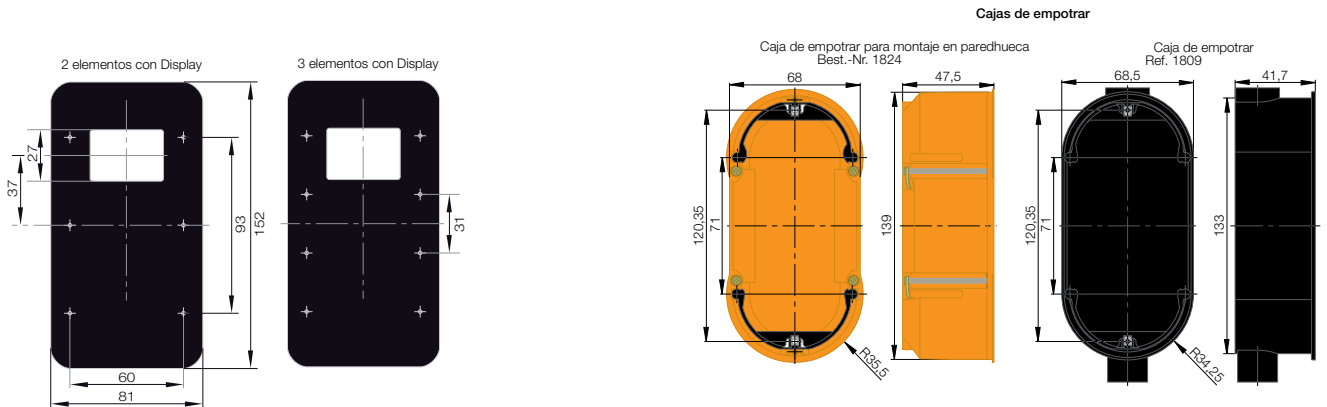

berker R.3

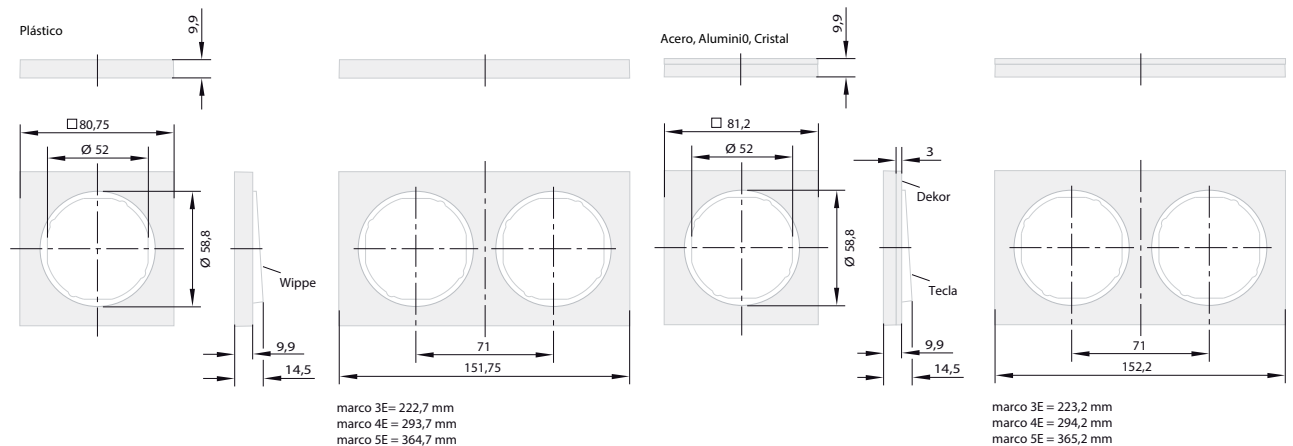

berker R.3 - Touch Sensor

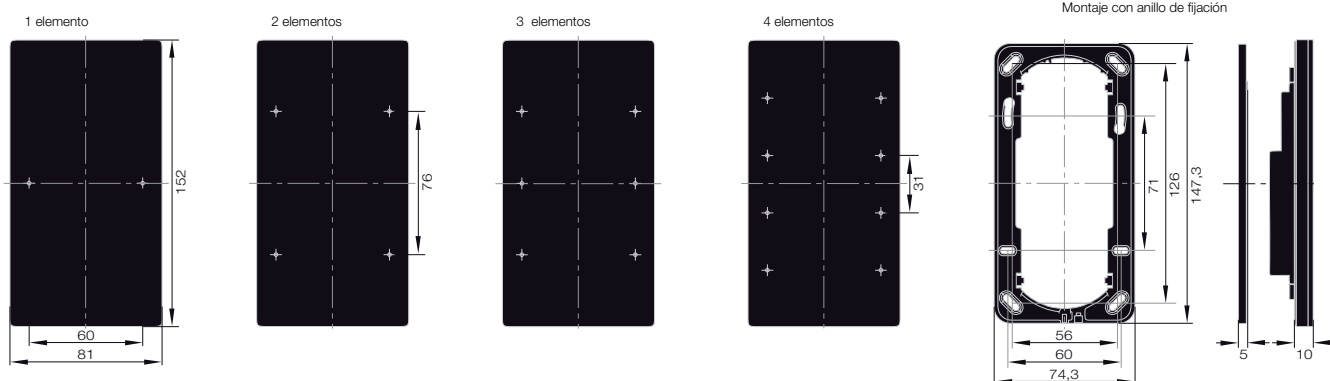

berker R.3 - Touch Sensor con regulador de temperatura

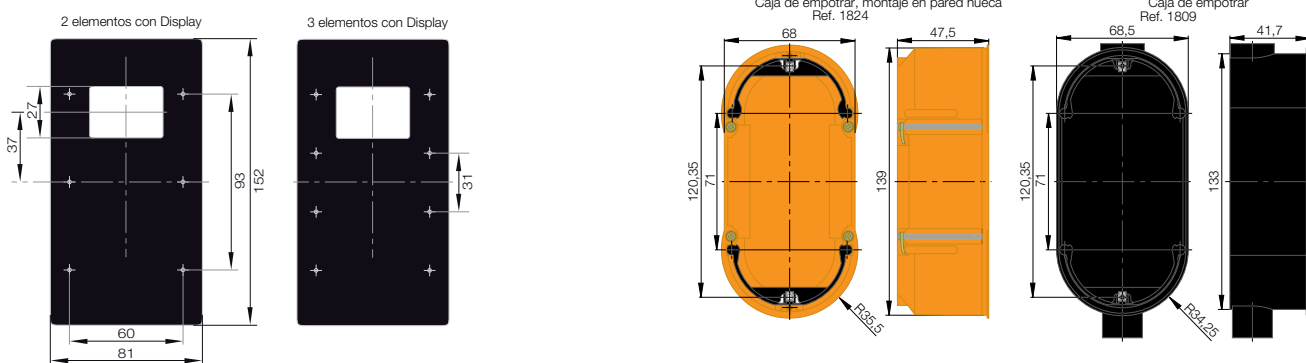

berker TS

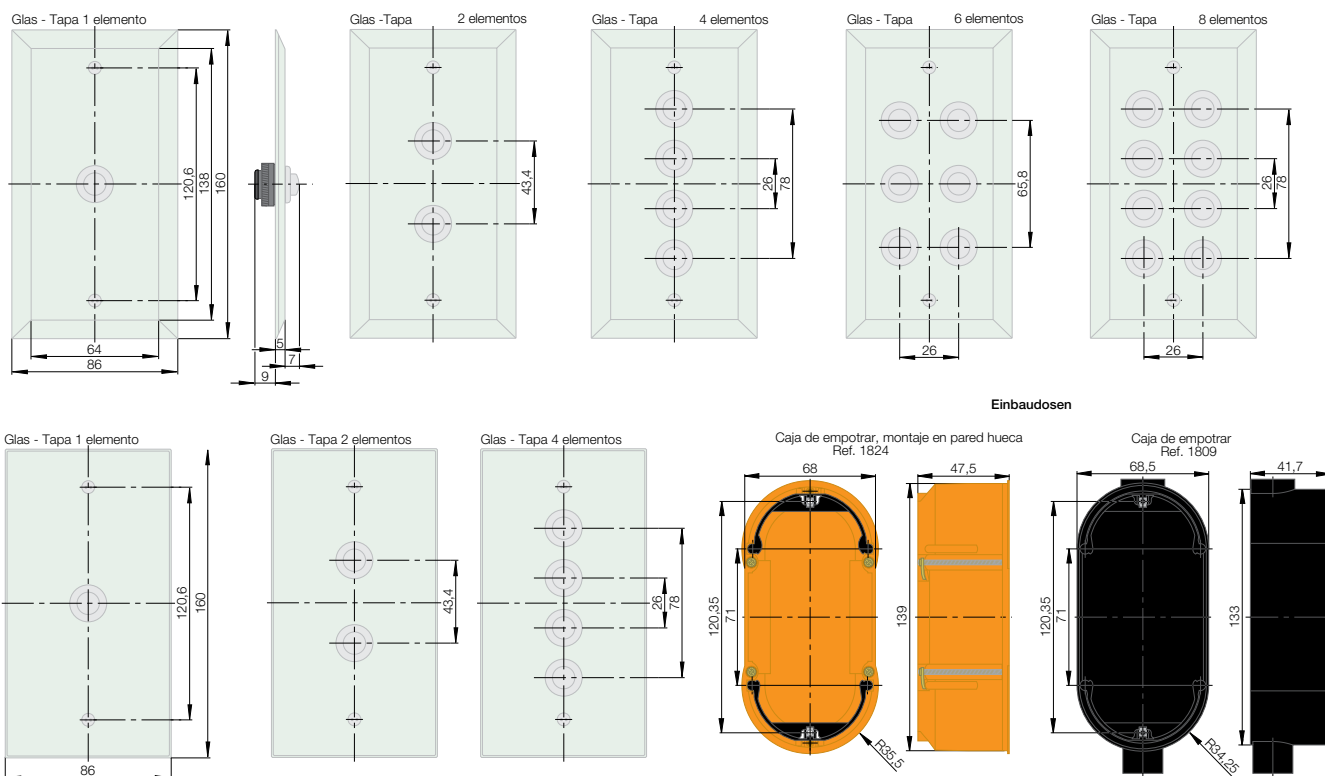

berker TS Sensor

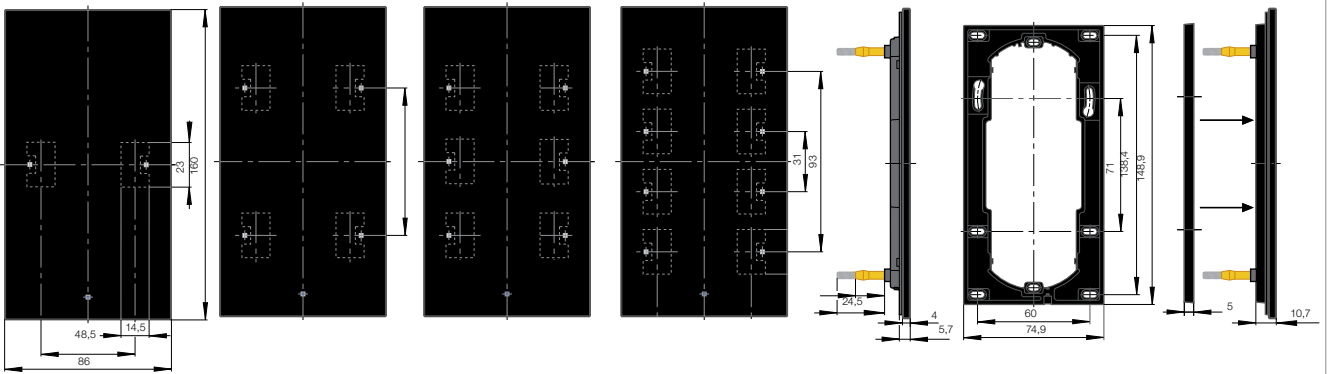

Glas-Sensor con termostato

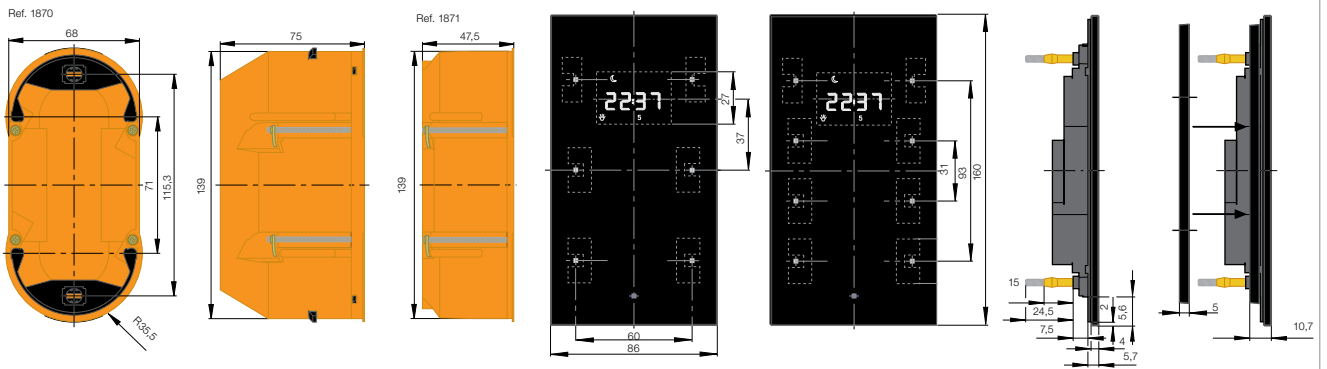

berker B.IQ

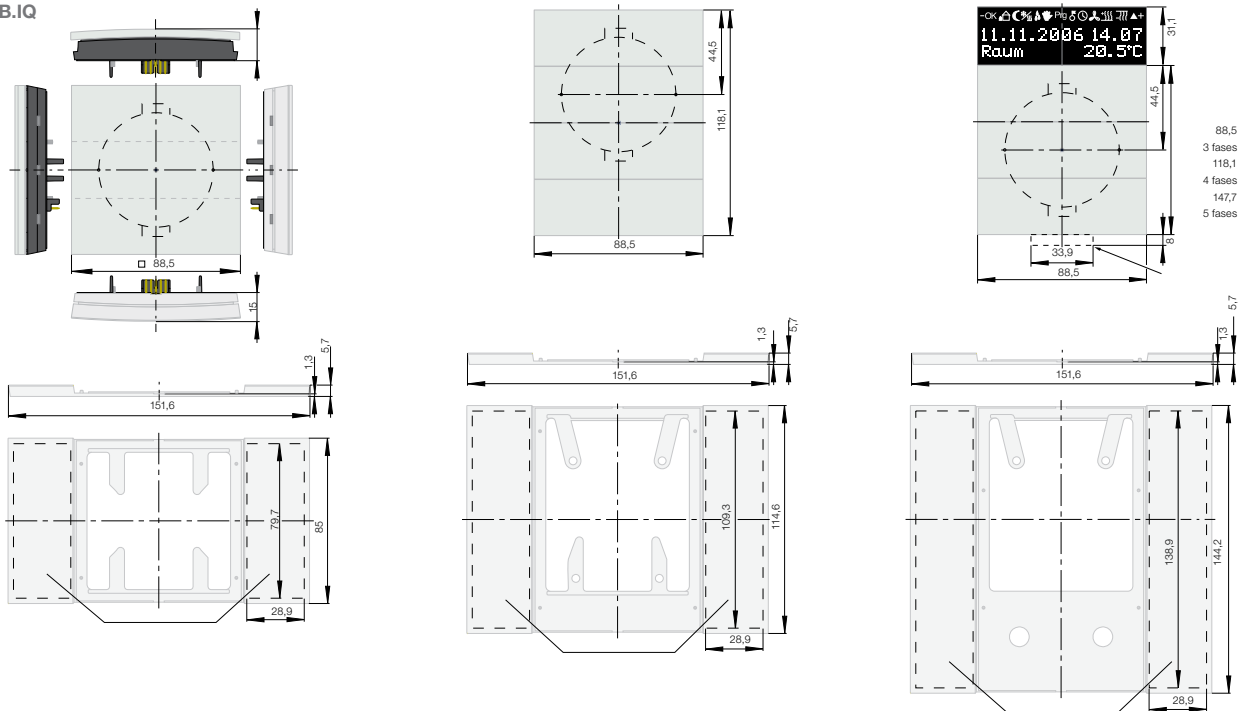

berker 1930 Porzellan Made By ROSENTHAL / Serie 1930

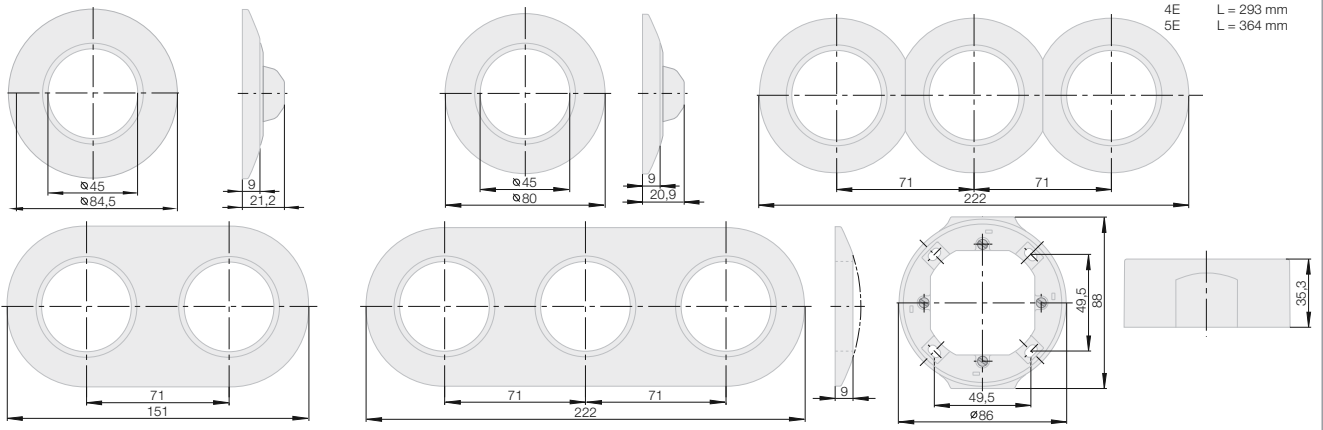

Marco 1 elemento para tapas centrales Ø 58 mm

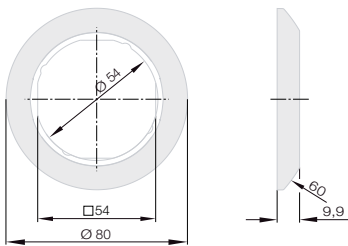

Serie Glas

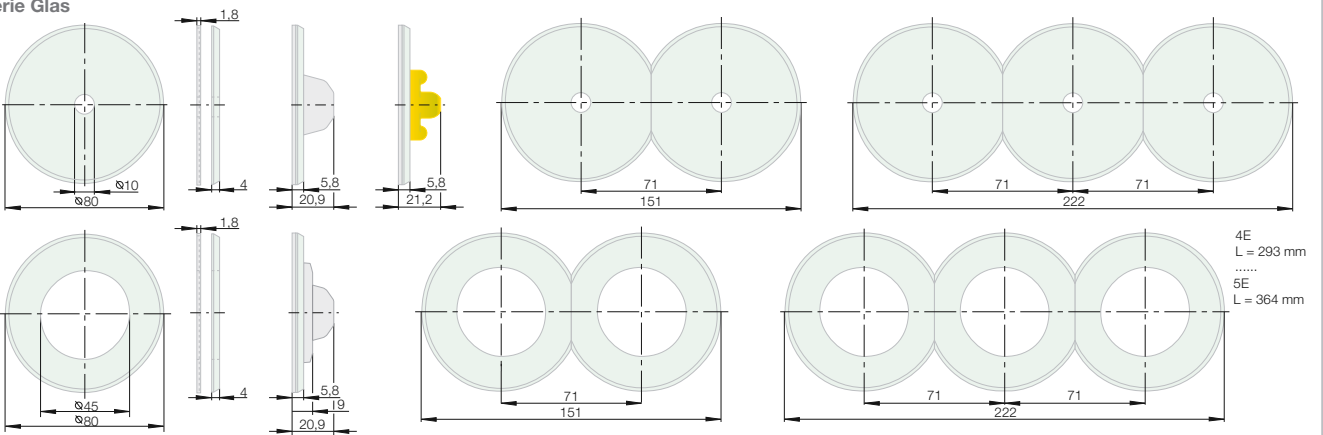

Serie R.classic

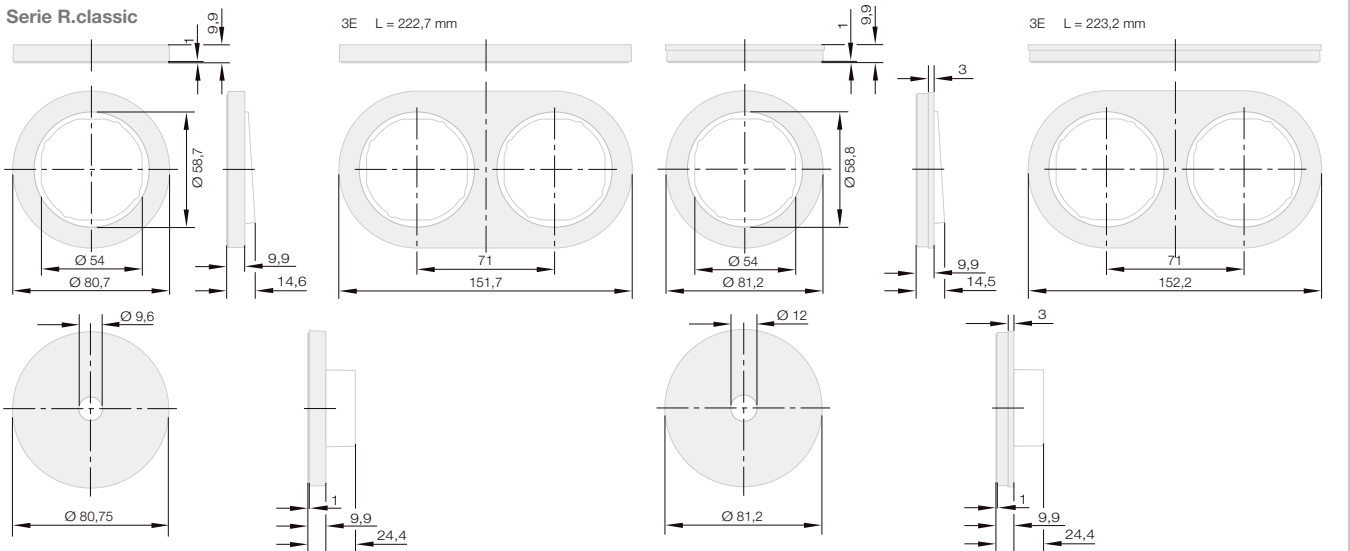

berker Integro

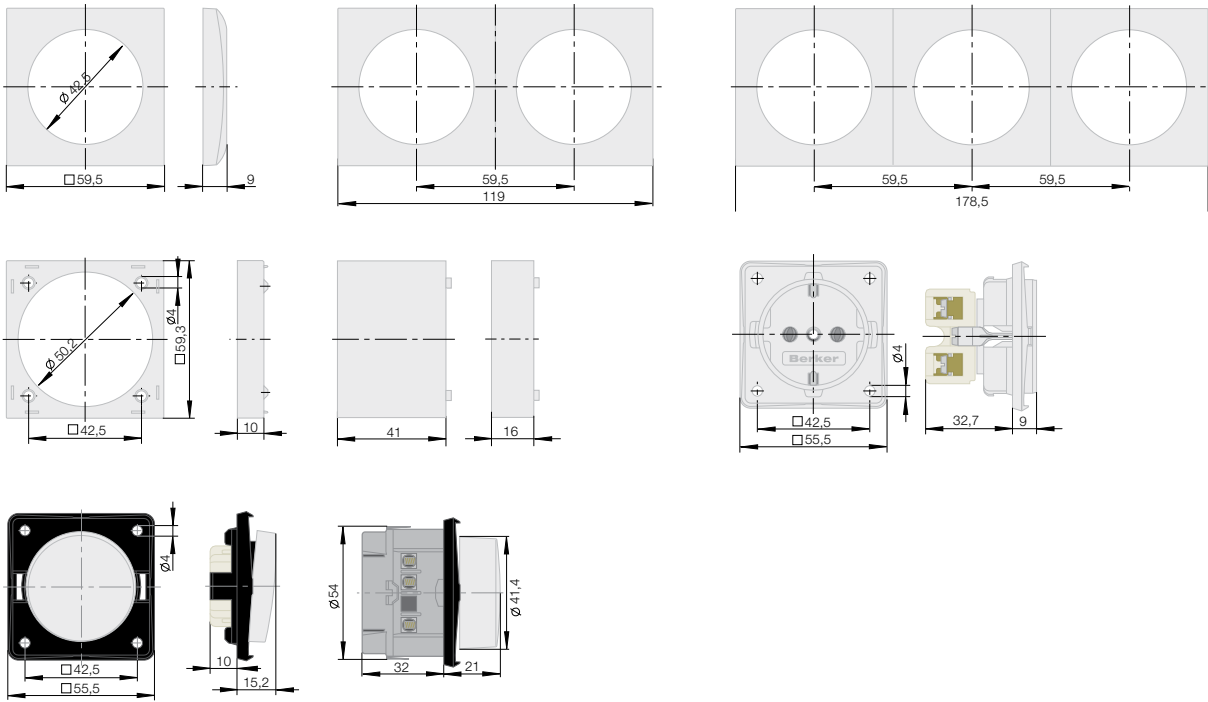

berker Integro

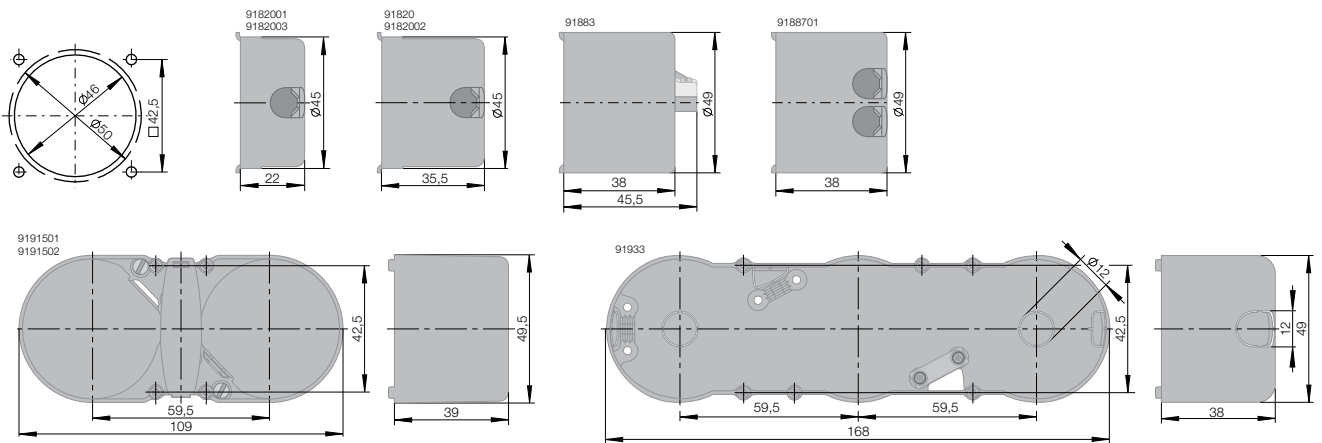

Conexión de lámparas

WNA002, WNA002B, WNA006, WNA006B, WNA021, WNA021B,
WNA023, WNA023B, WNA025, WNA025B, WNC002, WNC021,
WNC023, WNE023, WNE023B

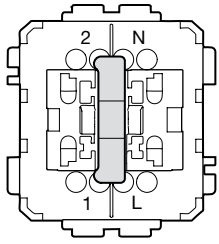

WNA003, WNA003B, WNC003

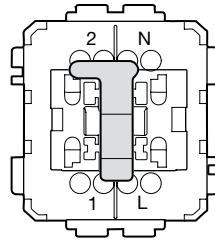

Conexión

WNA002, WNA002B, WNA006, WNA006B,

Conmutador luminoso

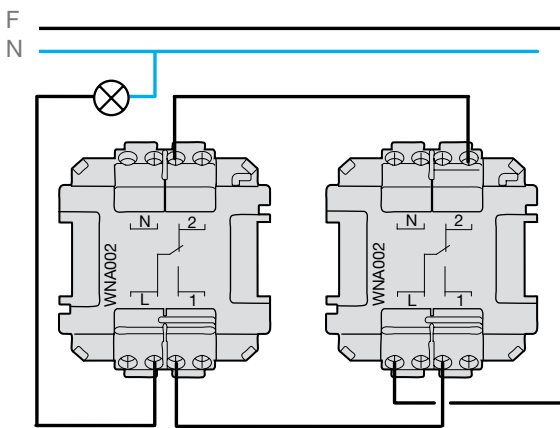

WNA003, WNA003B, WNC003

Conmutador testigo con neutro

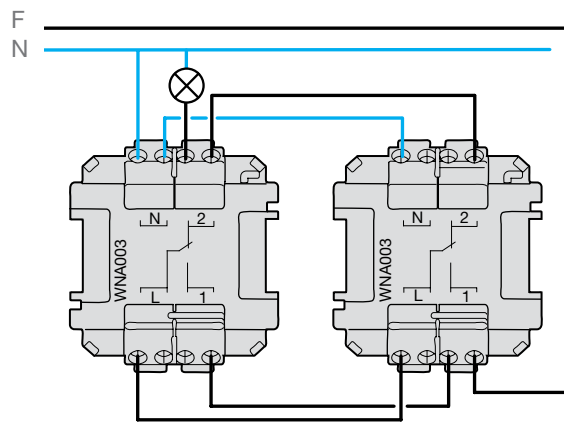

WNA001, WNA002

Conmutador testigo, cableado existente
un único punto de gestión testigo

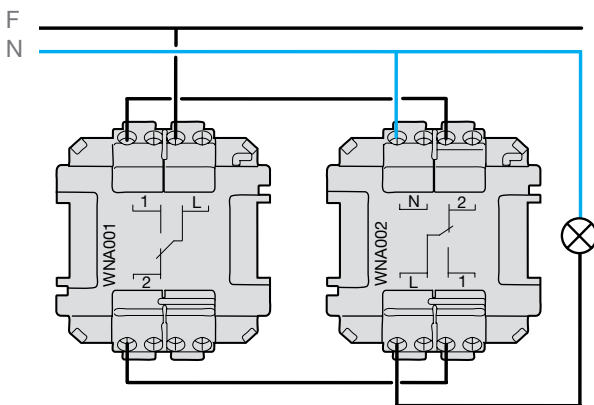

Invertir el sentido de montaje de la lámpara al conectarla entre L y N

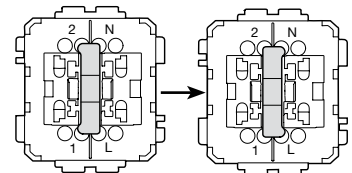

WNA695 - WNA696 - WNA697 - WNA698 - WNA699

Función señalización

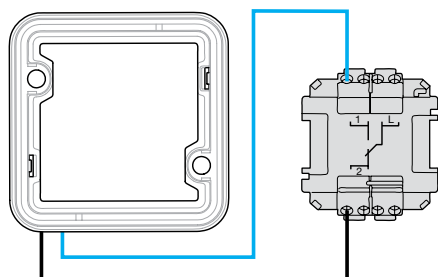

Función testigo

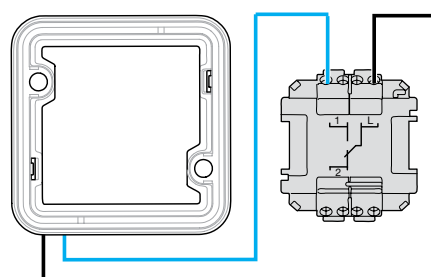

Conexionado

WNA002, WNA010

(Conexionado cruzamiento (función luminosa sólo sobre WNA002

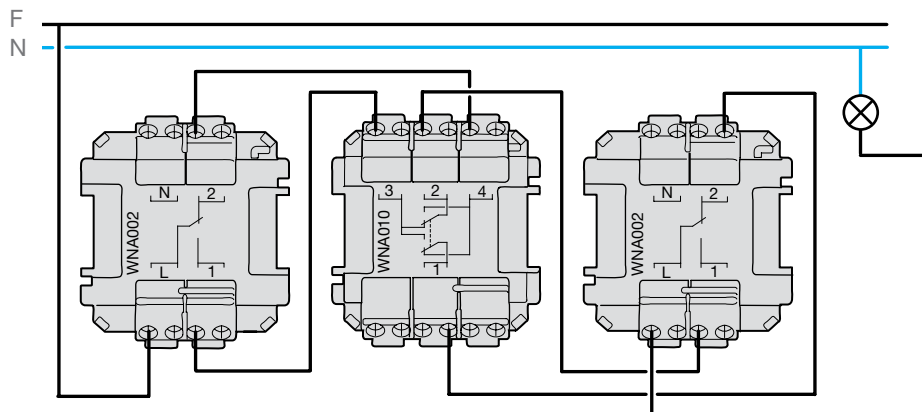

WNA023

Pulsador testigo

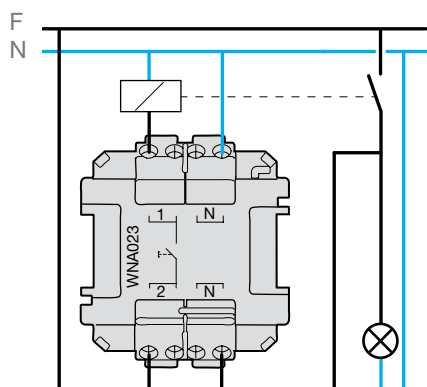

Lámpara conectada entre N/N

WNA023

Pulsador luminoso

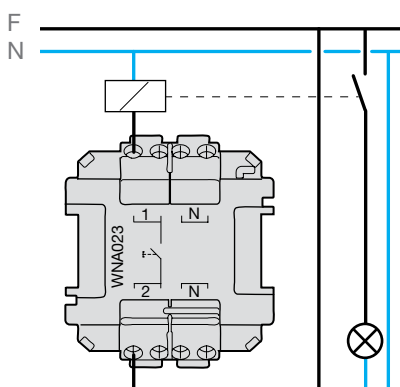

Lámpara a conectar entre 1 / 2

Especificaciones técnicas

		Función señalización			Función testigo		
		lámpara 250V	lámpara 24V	conexión	lámpara 250V	24V lámpara	conexión
Conmutadores							
conmutador luminoso con neutro	WNA002x WNA006x	WUZ690 azul WUZ695 rojo WUZ698 blanco	WUZ692 azul WUZ697 rojo	1 / 2	WUZ691 rojo WUZ696 azul WUZ699 blanco	-	N / 2
conmutador testigo con neutro	WNA003x WNC003	WUZ690 azul WUZ695 rojo WUZ698 blanco	WUZ692 azul WUZ697 rojo	1 / 2	WUZ691 rojo WUZ696 azul WUZ699 blanco	-	N / 2
Pulsadores							
inversor luminoso con neutro	WNA021x WNC021	WUZ690 azul WUZ695 rojo WUZ698 blanco	WUZ692 azul WUZ697 rojo	1 / 2	-	-	-
portaetiquetas luminoso	WNA025x WNC025 WNC025x	WUZ690 azul WUZ695 rojo WUZ698 blanco	WUZ692 azul WUZ697 rojo	1 / 2	-	-	-
testigo	WNA023x WNC023 WNE023x	WUZ690 azul WUZ695 rojo WUZ698 blanco	WUZ692 azul WUZ697 rojo	1 / 2	WUZ690 azul WUZ695 rojo WUZ698 blanco	WUZ692 azul WUZ697 rojo	N / N

Referencias en negrita: incluyen lámpara

Caja de superficie

Precorte de condensación

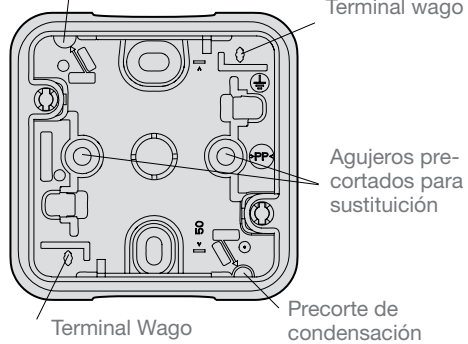

Romper el precorte con un destornillador. El agujero permite la evacuación de la condensación. El IP pasa de IP55 a IP44.

Fijación

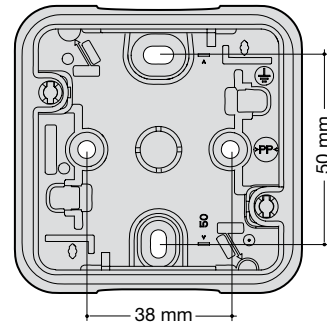

Dimensiones

Superficie

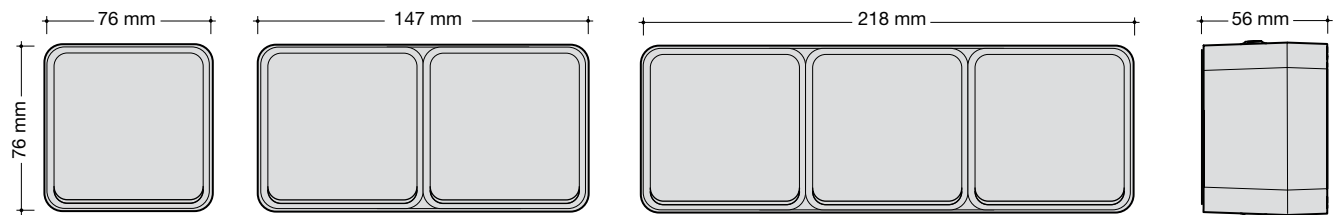

Empotrar

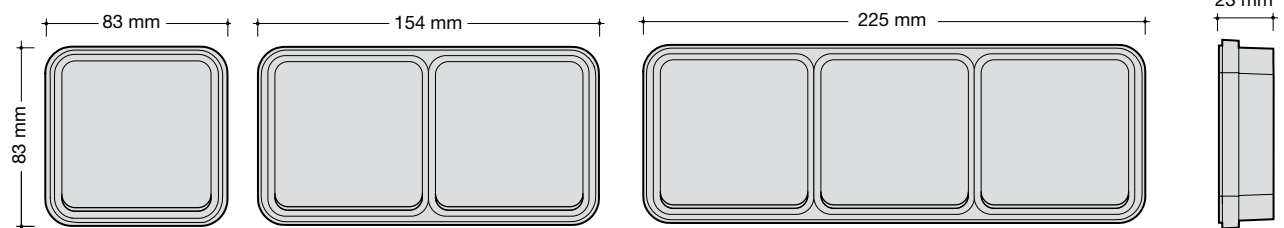

Fijación en pladur

Empotrar

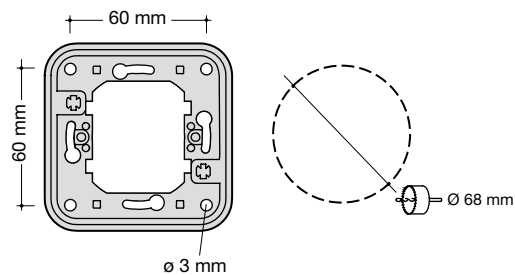

Especificaciones técnicas

Índice de protección	IP55 e IK07
Resistencia al frío y al calor (almacenaje)	de -40 °C a +60 °C
Resistencia al frío y al calor (funcionamiento)	de -40 °C a +60 °C
Resistencia a los rayos ultravioleta	500 horas a 550 W/m ²
Resistencia a niebla salina	7 días (168 h)
Resistencia a hilo incandescente	850°C, de conformidad a NF EN 60 695-2
Mantenimiento	Limpiar con un paño húmedo y agua con jabón No utilizar tricloroetileno Para cualquier otro producto, realizar una prueba previa
RAL: versión gris	Cajas soportes y cubiertas: RAL 7011 - Collarín RAL 7035
RAL: versión blanca	RAL 9010
Materiales	Polipropileno

Resistencia a agentes químicos a 20 °C

Acetato de amilo	+
Acetato de amonio	+
Acetato de sodio	+
Acetato de etilo	+
Acetona	+
Ácido acético al 10%	+
Ácido acético al 50%	+
Ácido benzoico	+
Ácido bórico	+
Ácido bórico (solución acuosa saturada)	+
Ácido clorhídrico al 10%	+
Ácido clorhídrico al 36%	+
Ácido cítrico	+
Ácido de la batería	+
Ácido fluorhídrico al 40%	+
Ácido fórmico	+
Ácido láctico	+
Ácido nítrico al 25%	+
Ácido nítrico al 50%	-
Ácido oleico	+
Ácido oxálico	+
Ácido fosfórico	+
Ácido esteárico	+
Ácido sulfúrico al 10%	+
Ácido sulfúrico al 85%	+
Ácido tánico	+
Alcohol amílico	+
Alcohol bencílico	+
Alcohol etílico	+
Alcohol isopropílico	+
Alcohol metílico (metanol)	+
Aluminio	+
Amoniaco	+
Anhidrido acético	+
Anilina	+
Anticongelante	+
Bario	+
Benceno	-
Butiro	+
Cerveza	+
Bromuro	+
Butano	+
Cacao	+
Café	+
Carbonato de amonio	+

Carbonato de calcio	+
Cloro	-
Cloroformo	+
Cloruro de amonio	+
Cloruro de cal	+
Cera de abejas	+
Mermelada	+
Nata	+
Dentífrico	+
Detergente	+
Agua	+
Agua de cloro (líquido gaseoso)	-
Agua marina	+
Harina	+
Queso	+
Fructosa	+
Gelatina	+
Ginebra	+
Glucosa	+
Glicerina	+
Glicol	+
Alquitrán	+
Aceite alimentario	+
Aceite de motor	+
Aceite de palma	+
Aceite de oliva	+
Aceite mineral	+
Hidrógeno	+
Hipoclorito de sodio al 13%	-
Zumo de fruta	+
Keroseno	-
Leche	+
Legumbres	+
Líquido de frenos	+
Lavavajillas	+
Margarina	+
Mayonesa	+
Mercurio	+
Miel	+
Mostaza	+
Nitrato de amonio	+
Nitrato de sodio	+
Ozono	+
Parafina	+
Perfume	+
Petróleo, éter de petróleo	-

Fenol	+
Fosfato de amonio	+
Fósforo	+
Potasio	+
Propano	+
Ron	+
Jabón	+
Sal	+
Sal de aluminio	+
Sal de plata	+
Sal de carbonato	+
Sal de cloruro	+
Sal de cobre	+
Sal de magnesio	+
Sal de sulfito	+
Sal de cinc	+
Champú	+
Soda	+
Sodio	+
- Acetato de sodio	+
- Carbonato de sodio	+
- Cloruro de sodio (sal)	+
- Fosfato de sodio	+
- Sulfato de sodio	+
Azúfre	+
Azúcar	+
Sulfato de amonio	+
Trementina	-
Té	+
Tricloroetileno	-
Orina	+
Vaselina	+
Vino	+
Vinagre	+
Whisky	+
Aguarrás	+

+ : Buena resistencia

- : Inestable

Configuración de los productos tebis.quicklink

Las configuraciones complicadas son cosas del pasado. Ahora, puede definir las funcionalidades de sus dispositivos rápidamente vía quicklink. tebis.quicklink es un método sencillo de programación, basado en el estándar KNX radio y soportado por los productos de las series berker. La característica más importante es lo sencillo que resulta su uso. En pocas pulsaciones, el dispositivo asume la funcionalidad que deseamos. Así, es posible utilizar un pulsador radio o mando a distancia para gestionar iluminación, persianas, detectores de movimiento o puertas de garaje. Todas las soluciones son compatibles entre sí. Pueden enlazarse hasta 20 dispositivos. Del mismo modo, aplicaciones mucho más complejas como temporizaciones o escenas también pueden configurarse vía tebis.quicklink.

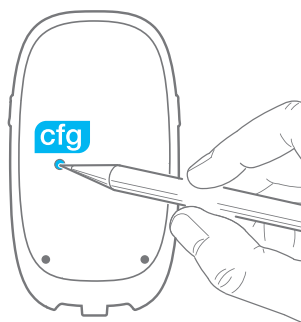

1

Modo configuración

Presionar pulsador cfg del transmisor brevemente. El LED cfg del transmisor y de todos los receptores se ilumina.

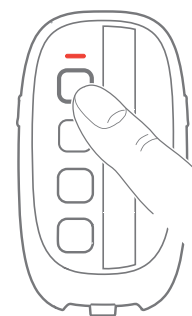

2

Selección entrada

En el transmisor, pulsación breve en el pulsador que queremos configurar. El LED cfg del transmisor parpadea durante un segundo. El transmisor y receptor están ahora en modo configuración.

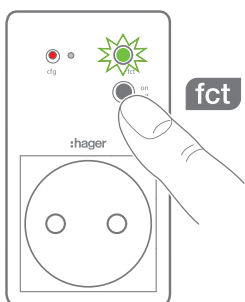

3

Selección función

Mantener pulsado el pulsador fct del receptor hasta que el LED fct muestre la función deseada.

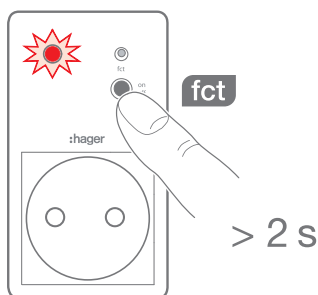

4

Confirmar función

Para confirmar la función seleccionada, mantener pulsado el pulsador fct del receptor no más de 2 segundos, hasta que el LED cfg parpadee. Para configurar controles de grupo, repetir los pasos 3 y 4 en los demás receptores del grupo.



5

Fin configuración

Pulsar pulsador cfg del transmisor brevemente. Los LED cfg del transmisor y de los receptores se apagan.

	On-Off	Variador	Persianas-Toldos
LED fct	Función	Función	Función
	on/off ON/OFF (Telerruptor)	ON/OFF variador +/-	
	on ON	+ ON, variación +	Subida, interrupción
	off OFF	- OFF, variación -	Bajada, interrupción
	1 Escenario 1	1 Escenario 1	1 Escenario 1
	2 Escenario 2	2 Escenario 2	2 Escenario 2
	Temporizador	Temporizador	
	ON/OFF (interruptor)	ON/OFF (interruptor)	Mando persianas (interruptor)
	on Forzado ON		Forzado subida
	off Forzado OFF		Forzado bajada
	Borrado	Borrado	Borrado

Actuadores binarios de 4 a 10 canales

Fácil de instalar, seguro y completo. Estas características de Hager se aplican a todos los actuadores binarios equipados con las nuevas aplicaciones ETS. Estos dispositivos hacen que la instalación sea más segura y fácil de utilizar.

Tanto sus características físicas como las de software responden a necesidades actuales y futuras de los usuarios más exigentes, lo que les da un valor añadido.

Además, estos dispositivos son extremadamente flexibles. Por ejemplo, las salidas se pueden configurar para controlar circuitos de iluminación On/Off o persianas, según lo que se necesite. Así, es posible convertir un actuador de 4 salidas On/Off en un actuador de 2 salidas para estores/persianas o en un actuador con 2 canales On/Off y 1 salida para estores.

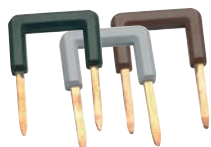

Práctico: puentes de conexión para facilitar las conexiones, disponibles en distintos colores

TG200A ...B ...C

Conexiones rápidas y seguras, con la tecnología QuickConnect

Versión de 8 canales con funcionamiento manual, aunque no haya conexión de bus KNX

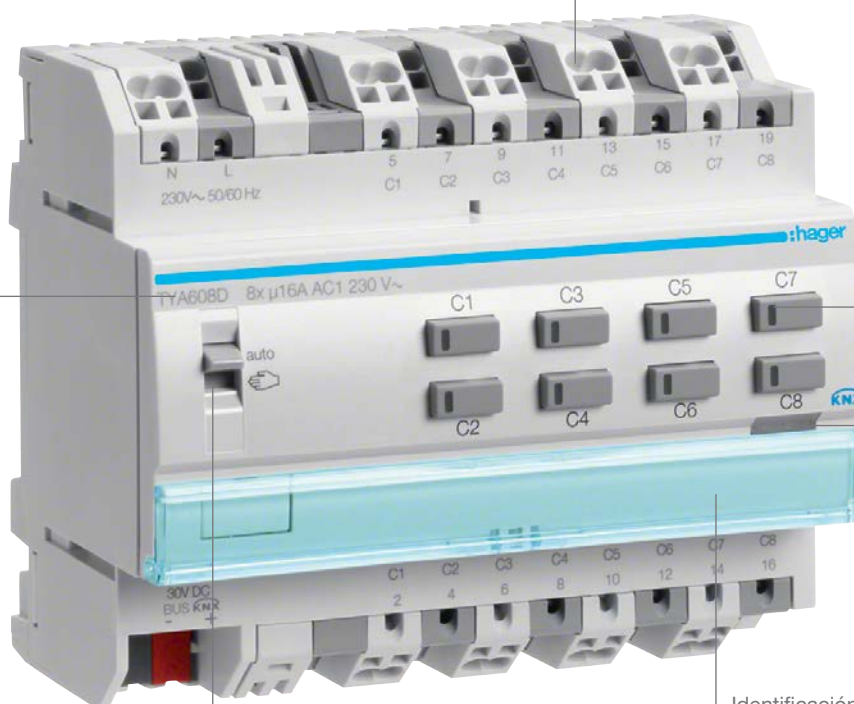

Con botón de control manual y dispositivo de señalización de estado integrado

Programación más fácil: botón de direccionamiento físico disponible en la cara frontal del producto

Libertad de elección: conmutador para funcionamiento automático o manual

Identificación precisa: porta etiquetas para identificar el producto

Ventajas:

- Ocupación reducida de espacio debido a su diseño compacto
- Tecnología QuickConnect
- Conexiones transversales
- Con portaetiquetas
- El control manual se puede bloquear (mediante el bus KNX)
- Los dispositivos de señalización se pueden desactivar

Características técnicas:

- Canales: 4, 6, 8 y 10.
- 4 A, 10 A, 16 A y 16 A cargas capacitivas
- Ancho:
 - 4 y 6 canales - 4 módulos
 - 8 y 10 canales - 6 módulos
 - 6 canales con detección de corriente - 6 módulos
- Conexiones: conexiones rápidas 0,75 a 2,5 mm², cable flexible o rígido sin puntera
- Alimentación: por la parte inferior o superior de producto
- Control manual: botón de control con dispositivo de señalización
- Aplicaciones: On / Off y/o estores

Características técnicas

	TYA604A TYA606A TYA608A TYA610A	TYA604B TYA606B TYA608B TYA610B	TYA604C TYA606C TYA608C TYA610C	TYA604D TYA606D TYA608D TYA610D	TYA606E	TYB601A TYB602A
Tipo de producto (instalación)	Modular, para carril DIN					Empotrar
Corriente nominal In (A)	4 A	10 A	16 A	16 A cargas capacitivas	16 A cargas capacitivas	4 A
Tensión nominal Vn (V)	250/440 V CA					250 V CA
Número de canales	4 / 6 / 8 / 10				6	1 / 2
Ancho (en módulos)	4 / 4 / 6 / 6				6	53 x 29 mm
Control manual con alimentación KNX	sí				sí	
Control manual sin alimentación KNX	no / no / sí/ no					
LED de señalización de estado	sí					
Porta etiquetas	sí					no
Medición de corriente	no				sí	no
Alimentación KNX	30 V DC MBT (opcional, 230 V CA para TYA608A/B/C/D 230V AC)					
Disipación máxima	1/1/2/3 W	3/5/6/7 W	8/12/12/15 W		6 W	225 mW
Consumo típico del bus KNX	4 / 4,3 / 15,2 / 15,9 mA				6,2 mA	5,3/5,9 mA
Consumo en reposo del bus KNX	3,3 / 3,3 / 8,6 / 7,5 mA				5,1 mA	4,7 mA
Número máximo de conmutaciones en plena carga	6 ciclos/minuto					
Corriente máxima por producto (suma)	16/24/32/40 A	30/45/60/75 A	45/60/80/100 A		68 A	
Gama de medición de corriente	no				0,02 - 16 A	no
Precisión de la gama de medición de corriente	no				< 2% +/- 10 mA	no
Intervalos mínimos de medición de corriente	no				50 mA	no
Contacto AC1 (cos = 0,8) DIN EN 60947-4-1	4 A	10 A	16 A			4 A
Capacidad de conmutación de cargas capacitivas	no			16 A (200 µF)	16 A (200 µF)	no
Bombillas incandescentes 230 V AC	800 W	1200 W	2300 W	2300 W	2300 W	600 W
Bombillas fluorescentes T5/T8:						
- no compensadas	800 W	1000 W	1200 W	1200 W	800 W	600 W
- con transformador (mono o doble)	12 x 36 W	15 x 36 W	20 x 36 W	20 x 36 W	25 x 18 W	6 x 58 W
- balastros convencionales, paralelo	no			1500 W (200 µF)	1000 W (130 µF)	no
Bombillas halógenas BT:						
- transformador ferromagnético	800 W	1200 W	1600 W			600 W
- transformador electrónico	800 W	1000 W	1200 W		1380 W	600 W
Bombillas halógenas 230 V	800 W	1200 W	2300 W			600 W
Bombillas de bajo consumo 230 V (CFL)	6 x 23 W	12 x 23 W	18 x 23 W	18 x 23 W	25 x 18 W	6 x 18 W
Bombillas LED:	72 W	144 W	200 W			
- Número máximo de bombillas LED / CFL	6	12	18	18	18	
Tipo de conexiones	QuickConnect					Bornes con tornillo
Conexiones: cable flexible o rígido	0,75 - 2,5 mm ²					

Características técnicas

	TYA604A TYA606A TYA608A TYA610A	TYA604B TYA606B TYA608B TYA610B	TYA604C TYA606C TYA608C TYA610C	TYA604D TYA606D TYA608D TYA610D	TYA606E	TYB601A TYB602A
Actuadores						
- Retraso al conectar y desconectar	sí					
- Temporizaciones (se pueden interrumpir/reiniciar)	sí					
- Aviso previo de extinción	sí					
- El objeto "Duración" se puede modificar	sí					
- Parpadeo	sí					
- Tipo de contacto configurable; NA o NC	sí					
- Valores predefinidos (con 1 o 2 objetos)	sí					
- Bloqueo (con 1 o 2 objetos)	sí					
- Forzado (2 bits)	sí					
- El control manual se puede configurar (activo/inactivo/estado)	sí					
- Indicación de estado con retraso en el envío	sí					
Detección de corriente						
- Valor actual para confirmación de funcionamiento	no				sí	-
- Definición de valor máximo y/o mínimo (1 o 2)	no				sí	-
- Mensaje de falta de corriente (después de x horas)	no				sí	-
- Contador de maniobras	no				sí	-
- Transmisión del valor medido	no				sí	-
- Alarma: medición de corriente con contacto abierto	no				sí	-
Funciones de escenas						
- Máx. 64 escenas por salida	sí					
- Memorización de escenarios mediante pulsación larga	sí					
- Funciones de escenario ON / OFF / Parpadeo	sí					
Funciones lógicas						
- 2 bloques lógicos por canal	sí					
- Máx. 4 entradas por bloque lógico	sí					
- Función E	sí					
- Función OU	sí					
Funciones especiales						
- Objeto "Restablecimiento por parámetro ETS"	sí					
- Desconectar dispositivos de señalización de estado	sí					
- Acción en ausencia/retorno del bus KNX	sí					
- Acción después de descargar ETS	sí					

Salida con detección de corriente

Con detección de corriente: actuador binario de 6 canales TYA606E

Este actuador de 6 canales cuenta con un poder de corte de 16 A por canal y está especialmente adaptado al control de cargas capacitivas. De esta forma, es posible controlar prácticamente cualquier tipo de carga: bombillas incandescentes o halógenas de 230 V, de halógeno mediante transformador ferromagnético o electrónico, bombillas

fluorescentes, bombillas de bajo consumo fluorescentes compactas de hasta 25 x 18 W y bombillas LED 230 V de hasta 216 W.

Funciones de supervisión

La función más relevante de este producto es su capacidad para detectar y supervisar la corriente consumida en cada uno de sus canales. Esta función permite distintas funcionalidades innovadoras, como por ejemplo la medición

del valor de la corriente, la indicación de existencia de corriente en un software de visualización KNX, la definición de valores mínimos y máximos de corriente para activar las alarmas, el registro del valor máximo de corriente alcanzado, etc.

Estos datos se pueden enviar periódicamente o como respuesta a determinados eventos ocurridos en el bus KNX. El TYA606E es un producto único, ya que une las funciones de un actuador binario de

6 canales de 16 A a las funciones de una “central de alarmas técnicas”.

Funciones estándar

Este actuador dispone también de diversas funciones avanzadas por canal, como controles temporizados al conectar y/o desconectar, fases de forzado, funciones lógicas, funciones de bloqueo y recuento de horas de funcionamiento y conmutaciones.

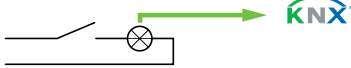
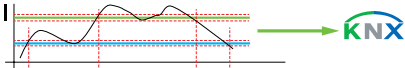
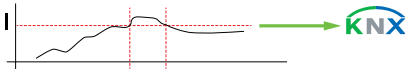
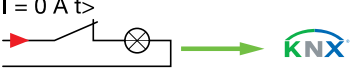
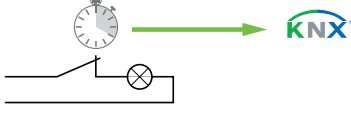
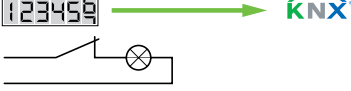
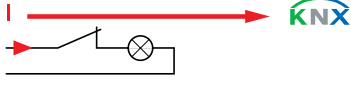
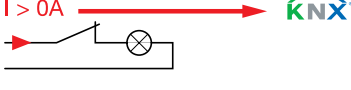
Función	Representación	Aplicación
Indicador de estado de salida con: - nivel de corriente medida - retraso en la medición regulable, para medir la potencia tras la conmutación		Supervisión del flujo y la carga en funcionamiento
Definición de valores límite máximo y/o mínimo de corriente (1 o 2)		¿Presenta la corriente los valores esperados?
Potencia máxima alcanzada (supera el límite)		Corriente máxima alcanzada, por ejemplo, en una toma
Alarma de ausencia de corriente detectada		Por ejemplo, alarma si el frigorífico no consume energía desde hace más de 6 horas
Contador de horas de funcionamiento (Contacto abierto o cerrado)		Después de x horas de funcionamiento, es necesario sustituir las bombillas
Contador de maniobras		Por ejemplo, “¿Cuántas veces se encendió o se apagó una bombilla?”
Medición del valor actual de la potencia		Visualización del valor actual de la potencia medida
Medición de corriente con el contacto abierto		Detección de contacto “pegado”

Reguladores

Los reguladores universales con detección automática de carga pueden controlar todo tipo de cargas regulables, incluidas las fluocompactas de bajo consumo o tipo LED.

La gama incluye productos con capacidad de control de cargas de hasta 300, 600 o 900 W. Destaca el TYA663A, que permite la distribución de 900 W en distintos canales.

Son posibles las variantes 3 x 300 W, 1 x 600 W + 1 x 300 W, así como 1 x 900 W. El mismo producto puede controlar uno, dos o tres canales.

Al ser productos universales, estos actuadores pueden controlar cargas de tipo resistivo, inductivo o capacitivo.



- Fluocompactas
- Cargas capacitivas (CFL)
- Cargas inductivas
- LED
- Aprendizaje de la carga (CFL + LED)
- Regulaciones de fábrica (modo automático)

El color del dispositivo de señalización indica el modo de funcionamiento que se está utilizando

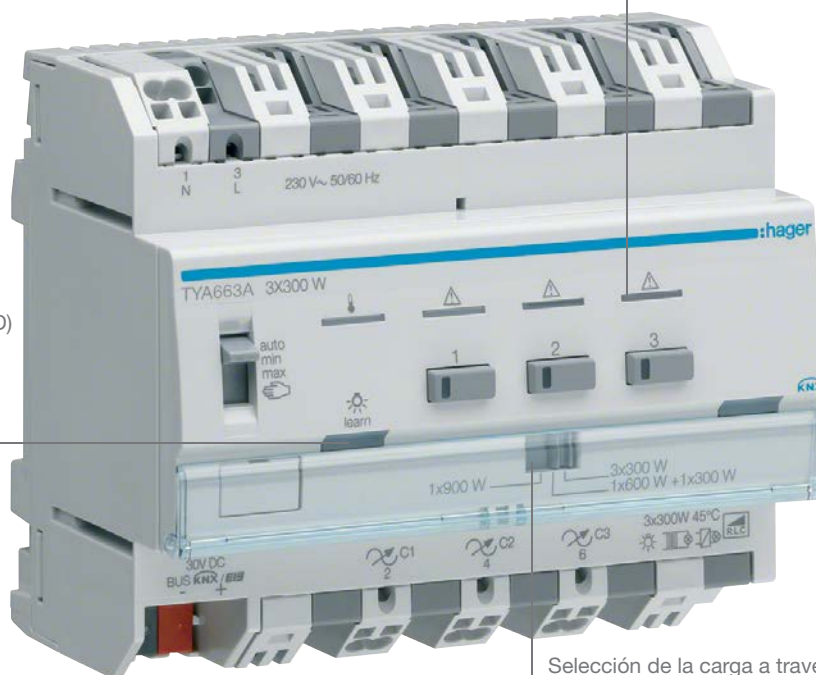

Con protección contra sobrecargas y cortocircuitos:

- parpadeo: cortocircuito
- fijo: sobrecarga (la carga se reduce automáticamente)

Selección de la carga a través del conmutador:
1 x 900 W o
1 x 600 W + 1 x 300 W o 3 x 300 W

Ventajas:

- Regulador universal patentado, con detección automática de carga
- Adaptado al control de bombillas (CFL) y LED
- Tras sustituir las bombillas, se ejecuta una nueva detección automática del tipo de carga
- Control manual (auto, mín., máx., manual)
- Dispositivo de señalización de estado y control manual posible sin el bus KNX
- Bornes de conexión rápida
- Programa de aplicación ETS muy completo

Características técnicas:

- Salidas: de 300 W (TYA661A) hasta 900 W (TYA663A)
- Dispositivos de señalización: cortocircuito, sobrecarga, sobrecalentamiento y estado
- Ancho:
 - 300 W y 600 W: 4 módulos
 - 900 W: 6 módulos
- Conexiones rápidas de 0,75 hasta 2,5 mm², conductor rígido o flexible sin puntera
- Control manual: auto/mín./ máx./manual, botón con dispositivo de señalización
- Aplicación: Iluminación regulable

Características técnicas

	TYA661A (1 x 300 W)	TYA661B (1 x 600 W)	TYA663A (3 x 300 W)		
Tipo de producto (instalación)	Modular, para carril DIN				
Tensión nominal Vn (V)	250 V CA				
Número de canales	1	1	3		
Ancho (en módulos)	4	4	6		
Control manual con alimentación KNX	sí				
Control manual sin alimentación KNX	sí				
LED de señalización de estado	sí				
Porta etiquetas	sí				
Alimentación KNX	30 V DC MBT				
Disipación máxima	4 W	7,5 W	8,9 W		
Consumo típico del bus KNX	2,3 mA				
Consumo en reposo del bus KNX	350 mW	350 mW	600 mW		
Bombillas incandescentes 230 V CA	300 W	600 W	1 x 900 W	1 x 600 W 1 x 300 W	3 x 300 W
Bombillas halógenas 230 V	300 W	300 W	1 x 900 W	1 x 600 W 1 x 300 W	3 x 300 W
Bombillas halógenas BT, con transformador ferromagnético	300 W	300 W	1 x 900 W	1 x 600 W 1 x 300 W	3 x 300 W
Con transformador electrónico	300 W	300 W	1 x 900 W	1 x 600 W 1 x 300 W	3 x 300 W
Bombillas de bajo consumo variables 230 V	60 W	120 W	1 x 210 W	1 x 120 W 1 x 60 W	3 x 60 W
Bombillas LED - Variables 230 V	60 W	120 W	1 x 210 W	1 x 120 W 1 x 60 W	3 x 60 W
- Número máximo de bombillas LED	8	10	15	15 8	3 x 8
Conexiones	QuickConnect				
Capacidad de conexión (rígida y flexible)	0,75 a 2,5 mm ²				
Funciones de variación					
- Variación relativa	sí				
- Variación absoluta	sí				
- Nivel de variación al conectar	sí				
- Tiempo para conectar y desconectar	sí				
- Temporizador (valor en %, parpadeo)	sí				
- Temporizaciones (se pueden interrumpir o reiniciar)	sí				
- Aviso previo de extinción	sí				
- El objeto "Duración" se puede modificar	sí				
- Valores predefinidos (con 1 o 2 objetos)	sí				
- Bloqueo (con 1 o 2 objetos)	sí				
- Forzado (2 bits)	sí				
- Control manual configurable (activo/inactivo/estatus)	sí				
- Indicación de estado con retraso de transmisión tras el retorno del bus	sí				
Funciones de escenas					
- Máx. 64 escenarios por salida	sí				
- Memorización de escenarios mediante presión larga	sí				
- Función de escenario Conectar/Desconectar/Parpadeo/Valor en %	sí				
Funciones lógicas					
- 2 bloques lógicos por canal	sí				
- Máx. 4 entradas por bloque lógico	sí				
- Función E	sí				
- Función OU	sí				
Objetos especiales					
- Modo de variación (inductivo, capacitivo, LED,...)	sí				
- Sobrecarga	sí				
- Cortocircuito	sí				
- Sobrecarga	sí				
- Defecto de carga (sin flujo de corriente)	sí				
Funciones especiales					
- Objeto "Restablecimiento por parámetro ETS"	sí				
- Objeto "Diagnóstico del producto"	sí				
- Desconectar dispositivos de señalización de estado	sí				
- Valor de variación en ausencia / retorno del bus KNX	sí				
- Acción después de descargar ETS	sí				
- Contador de horas de funcionamiento	sí				

Actuadores de estores y persianas

Actualmente, un sistema de control de motores para estores o persianas motorizadas tiene que ofrecer mucho más que los habituales controles para subir, bajar, parar u orientar las lamas. Por ejemplo, las funciones de protección solar están muy demandadas, ya que permiten la apertura y el cierre automáticos según la exposición solar. Estas novedosas funciones permiten más comodidad y seguridad.

Estos productos son especialmente versátiles. Además, a la hora de desarrollar los productos no solo se tiene en cuenta al usuario final, sino también al instalador eléctrico. Por ello, se ofrecen productos completos, fáciles de utilizar y, al mismo tiempo, con una instalación sencilla y rápida.

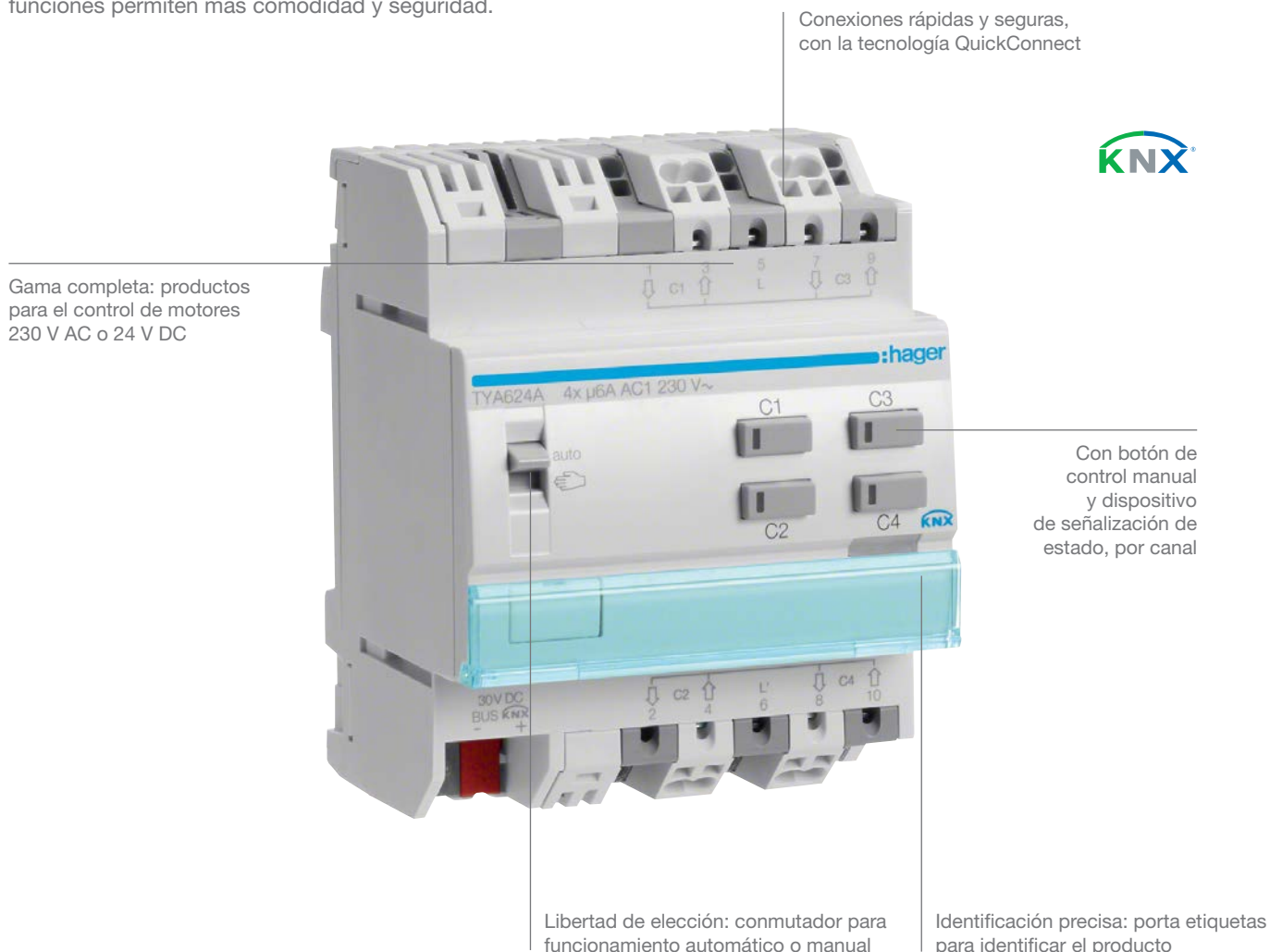

Ventajas:

- Dispositivos para control de motores 230 V y 24 V DC
- Diseño compacto
- Con tecnología QuickConnect
- Porta etiquetas
- Posibilidad de control manual
- Con indicación de estado por salida
- Control manual con opción a bloqueo (puede ser temporal)

Características técnicas:

- Tipo de salida: TYA624A/C y TYA628A/C para motores 230 V AC TYA624B/D para motores 24 V DC
- Poder de corte: 6 A por canal
- Ancho: 4 o 6 módulos
- Conexiones rápidas de 0,75 hasta 2,5 mm², conductor rígido o flexible sin puntera
- Control manual: por botón con dispositivo de señalización.
- Aplicación: persianas y estores

Características técnicas

	TYA624A (persianas) TYA624C (estores/persianas) TYA628A (persianas) TYA628C (estores/persianas)	TYA624B (persianas) TYA624D (estores/persianas)	TYB621C (estores/persianas)
Tipo de producto (instalación)	Modular, para carril DIN	Modular, para carril DIN	Empotrar
Tensión nominal Vn (V)	250/440 V AC	24 V DC	250 V AC
Corriente nominal In (A)	6 A AC1	6 A	4 A AC1
Número de canales	4 / 4 / 8 / 8	4 / 4	1
Ancho (en módulos)	4 / 4 / 6 / 6	4 / 4	53 x 29 mm
Control manual con alimentación KNX	sí		
Control manual sin alimentación KNX	sí		
LED de señalización de estado	sí		
Porta etiquetas	sí	sí	no
Alimentación KNX	30 V DC MBT	30 V DC MBT	30 V DC MBT
Disipación máxima	2 W	2 W	225 mW
Consumo típico del bus KNX	5,2 / 5,2 / 15,8 / 15,8 mA	5,2 / 5,2 mA	5,9 mA
Consumo en reposo del bus KNX	4,5 / 4,5 / 8,8 / 8,8 mA	4,5 / 4,5 mA	4,7 mA
Cadencia de conmutación máxima en carga plena	20 ciclos de conmutación / minuto		
Funciones			
- Subir/Bajar, Orientar lamas/Parar (estores)	no / sí / no / sí	no / sí	sí
- Subir/Bajar, Parar (persianas)	sí / sí / sí / sí	sí / sí	sí
- Posicionar en %	sí	sí	sí
- Posicionar lamas (0 - 100%)	no / sí / no / sí	no / sí	sí
- Tiempos de subida y bajada regulables	sí		
- Valores predefinidos (con 1 o 2 objetos)	sí		
- Bloqueo (con 1 o 2 objetos)	sí		
- Forzado (2 bits)	sí		
- Control manual configurable (activo/inactivo/estatus)	sí		
- Protección solar permanente/temporal	sí		
Funciones de seguridad			
- Máximo de 3 alarmas con prioridades definidas por el usuario	sí		
- Comportamiento durante/después de la alarma	sí		
- Tiempo de supervisión regulable	sí		
- Seguridad (movimiento, cuando se presiona)	sí		
Indicación de estado			
- Posición en %	sí		
- Posición de las lamas en %	no / sí / no / sí	no / sí	sí
- Posición del extremo superior alcanzado	sí		
- Posición del extremo inferior alcanzado	sí		
- Bloqueo	sí		
- Forzado	sí		
- Alarma	sí		
- Protección solar	sí		
- Función de seguridad	sí		
Funciones de escenas			
- Máx. 64 escenas por salida	sí		
- Memorización de escenarios mediante presión larga	sí		
- Función de escenario Subir/Bajar/Posición específica/Protección solar	sí		
Funciones lógicas			
- 2 bloques lógicos por canal	sí		
- Máx. 4 entradas por bloque lógico	sí		
- Función E	sí		
- Función OU	sí		
Funciones especiales			
- Objeto "Restablecimiento por parámetro ETS"	sí		
- Desconectar dispositivos de señalización de estado	sí		
- Objeto "Diagnóstico del producto"	sí		
- Respuesta ante ausencia / retorno del bus KNX	sí		
- Acción después de descargar ETS	sí		







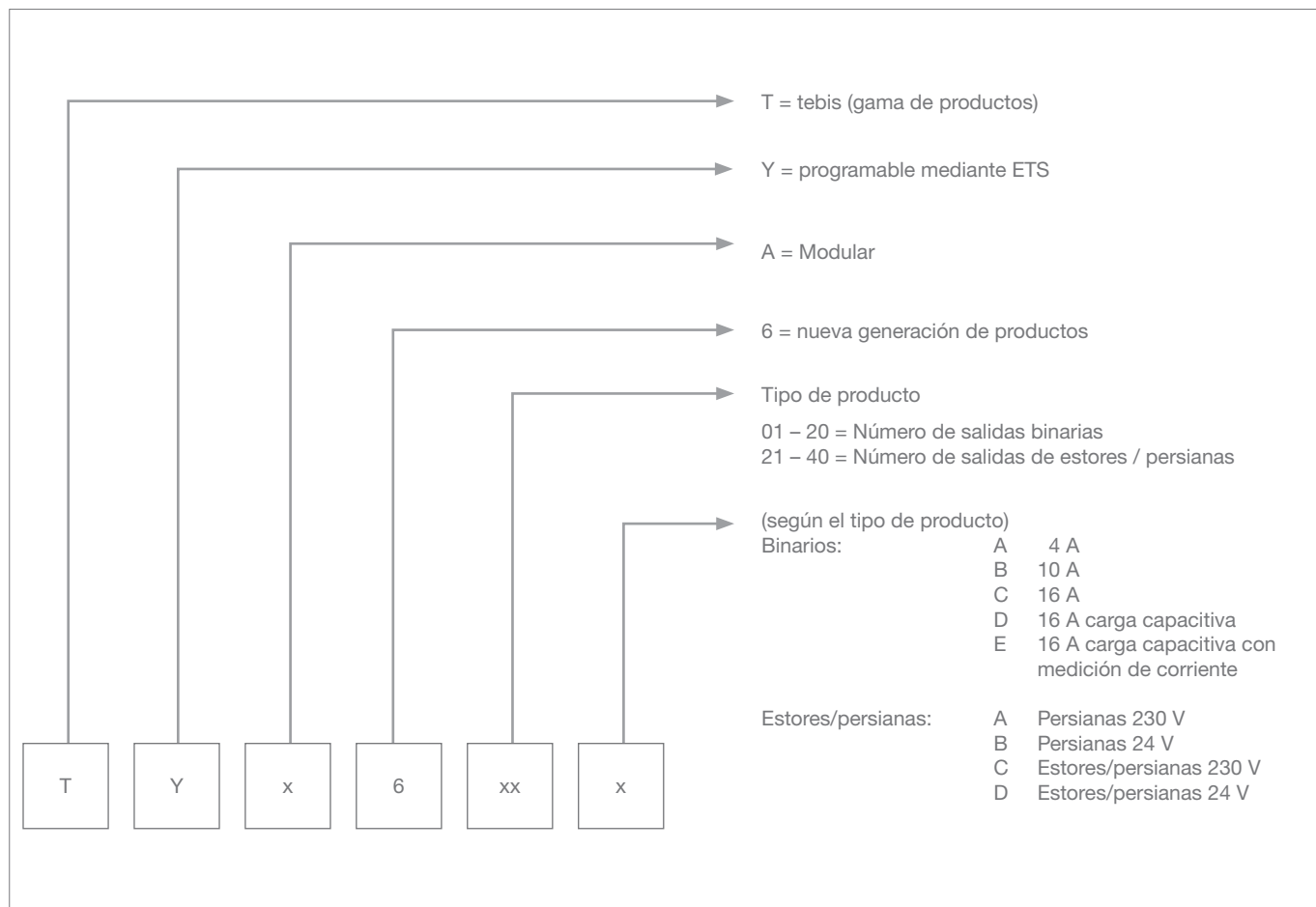











Identificación completa del producto en base a su referencia

El nuevo sistema de nomenclatura de productos KNX permite identificar los módulos rápidamente y de forma muy clara.

Sistema:



Actuadores binarios

	4 A	10 A	16 A	16 A cargas capacitivas	16 A cargas capacitivas con medición de corriente
10 canales	 TYA610A	 TYA610B	 TYA610C	 TYA610D	
8 canales	 TYA608A	 TYA608B	 TYA608C	 TYA608D	
6 canales	 TYA606A	 TYA606B	 TYA606C	 TYA606D	 TYA606E
4 canales	 TYA604A	 TYA604B	 TYA604C	 TYA604D	
2 canales	 TYB602A				
1 canal	 TYB601A				

Actuadores regulación

1 x 300 W	1 x 600 W	3 x 300 W
 TYA661A	 TYA661B	 TYA663A

Actuadores para estores / persianas

	Persianas 230 V	Estores / Persianas 230 V	Persianas 24 V DC	Estores / Persianas 24 V DC
8 canales	 TYA628A	 TYA628C		
4 canales	 TYA624A	 TYA624C	 TYA624B	 TYA624D
1 canal		 TYB621C		

Módulo multicanal de persianas

Para el control inteligente de persianas y celosías dispone ahora de 12 salidas en un dispositivo. Las 12 salidas se alimentan con 230 V y sirven para controlar los respectivos motores de las persianas y celosías. La aplicación ETS adaptada cubre todas las aplicaciones estándar incluyendo

amplias notificaciones de estado y tratamiento de alarmas por niveles. Durante el desarrollo se tuvo en cuenta la demanda de conexiones roscadas y se montaron bornes de caja con tornillos PZ1.

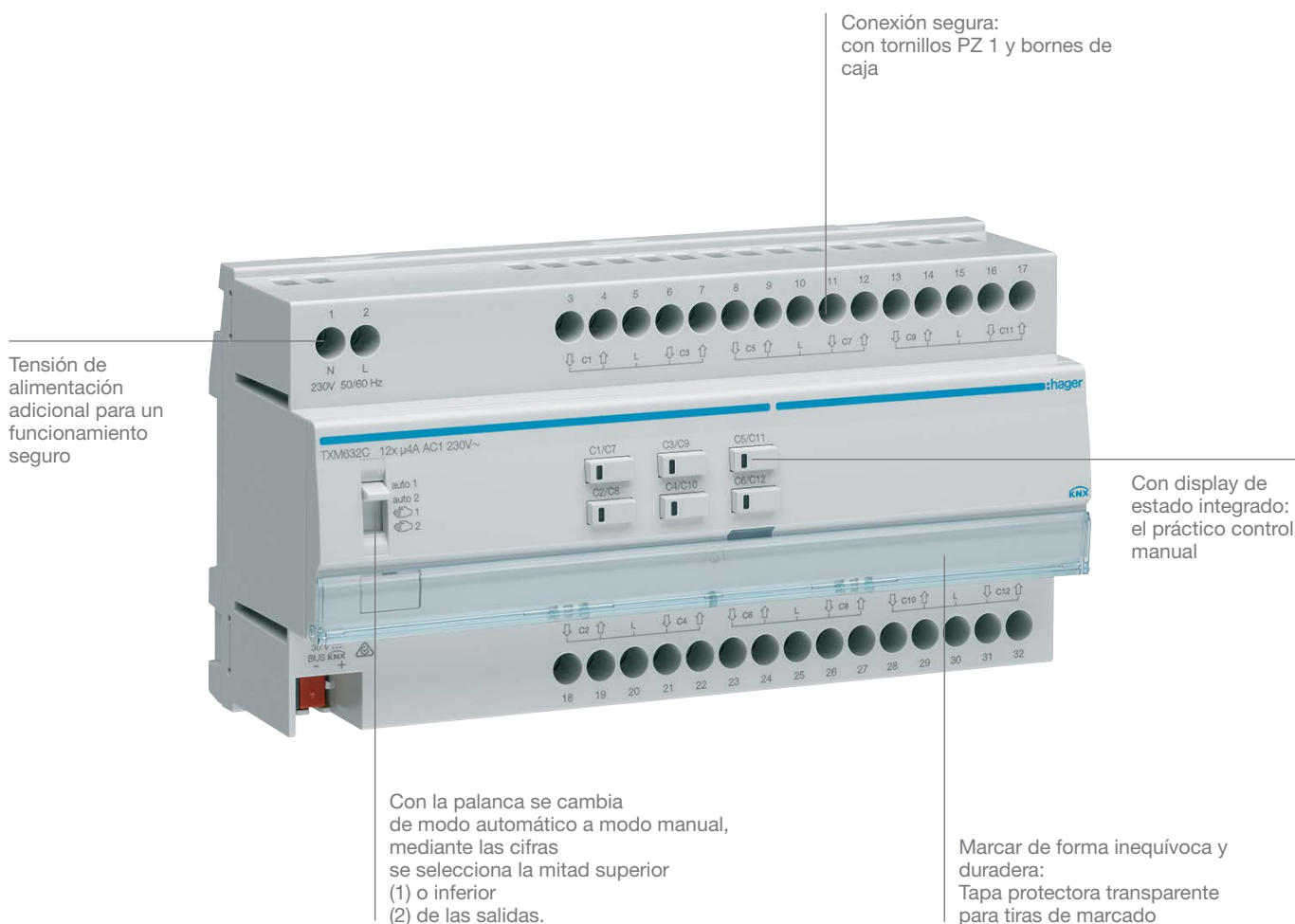

Ventajas:

- Actuador multicanal para 12 persianas o celosías
- Dispositivos para motores de 230V
- Ocupa poco espacio por su construcción compacta
- Funcionalidad idéntica de todos los canales
- Amplio campo para el marcado
- Control manual con display de estado integrado
- Programación easy + ETS

Características técnicas:

- | | |
|------------------------------|---|
| - Salidas: | 12 para motores 230-V
- siempre 2 salidas con fase propia
- posibilidad de conexión varias fases DC |
| - Intensidades de corriente: | - 4 A cada uno |
| - Espacio necesario: | - 10 PLE |
| - Conexión: | - Borne de caja estándar |
| - Control manual: | - Pulsador con display de estado |
| - Aplicación: | - Persianas y celosías |

Diferencia aplicación ETS TXM632C con los productos actuales TYA624C/TYA628C

	TXM632C	TYA624C / TYA628C
Modo de instalación	REG	REG
En tensión nominal (V)	250 / 440 V AC	250 / 440 V AC
En corriente nominal (A)	4 A AC1	6 A AC1
Número de salidas	12	4 / 8
Ancho de módulo (PLE)	10	4 / 6
Control manual con KNX tensión de Bus	sí	sí
Control manual sin KNX tensión de Bus	sí	sí
Display de estado LED	sí	sí
Ventana de marcado	sí	sí
Tensión de alimentación KNX	30 V DC SELV	30 V DC SELV
Disipación	3 W	2 W
Consumo propio típico en el KNX	7 mA	5,2 / 15,8 mA
Consumo propio en reposo en el KNX	5 mA	4,5 / 8,8 mA
Número de impulsos de cambio máximo con carga completa	6 ciclos/minuto	20 ciclos/minuto
Funciones		
- Arriba/abajo, paso de láminas/parada (función de celosía)	sí	sí
- Arriba/abajo, parada (función de persiana)	sí	sí
- Posición en %	sí	sí
- Giro de las lamas (0 - 100 %)	sí	sí
- tiempo de carrera ajustable hasta la posición final superior e inferior	sí	sí
- Preajustes (con 1 ó 2 objetos)	no	sí
- Función de bloqueo (con 1 ó 2 objetos)	no	sí
- Control forzado (2 Bit)	sí	sí
- Modo manual configurable (bloquear/desbloquear/estado)	no	sí
- Protección contra el sol permanente/con bloqueo temporal	no	sí
Funciones de seguridad		
- Como máximo 3 alarmas con prioridades definibles	no	sí
- Como máximo 3 alarmas con prioridades fijas	sí	no
- Comportamiento con/después de alarma	sí / estado teórico sin alarma	sí
- Tiempo de vigilancia ajustable	fijo, 30 minutos	sí
- Bloqueo de seguridad	no	sí
- Bajada de seguridad (recorrido mientras está pulsado)	no	sí
Aviso de estado		
- Posición en %	sí	sí
- Posición de lamas en %	sí	sí
- Tope superior alcanzado	sí	sí
- Tope inferior alcanzado	sí	sí
- Bloqueo	no	sí
- Control forzado (2 Bit)	sí	sí
- Alarma	sí	sí
- Protección contra el sol	no	sí
- Bloqueo de seguridad	no	sí
Función escena		
- Máx. 64 escenas por salida seleccionables	sí	sí
- Las escenas se pueden guardar pulsando la tecla más tiempo	sí	sí
- Acción ajustable con grabación de escenas	no	sí
- Funciones de escena arriba/abajo/posición específica	sí	sí
Función lógica		
- 2 bloques de lógica por dispositivo	no	sí
- Máximo 4 entradas por bloque de lógica	no	sí
- Conexión Y	no	sí
- Conexión O	no	sí
Funciones especiales		
- Objeto "Reiniciar a parámetros ETS"	no	sí
- Apagar display de los LEDs de los dispositivos	no	sí
- Objeto "diagnóstico de dispositivos"	no	sí
- Acción cuando fallo/vuelta tensión bus	no (mantener estado, fijo)	sí

Salidas binarias 16 y 20

Con 20 salidas en 10 módulos (16 A carga C) los dispositivos compactos ofrecen óptima funcionalidad en poco espacio.

Los dispositivos son adecuados para gestionar circuitos de iluminación o controlar persianas.

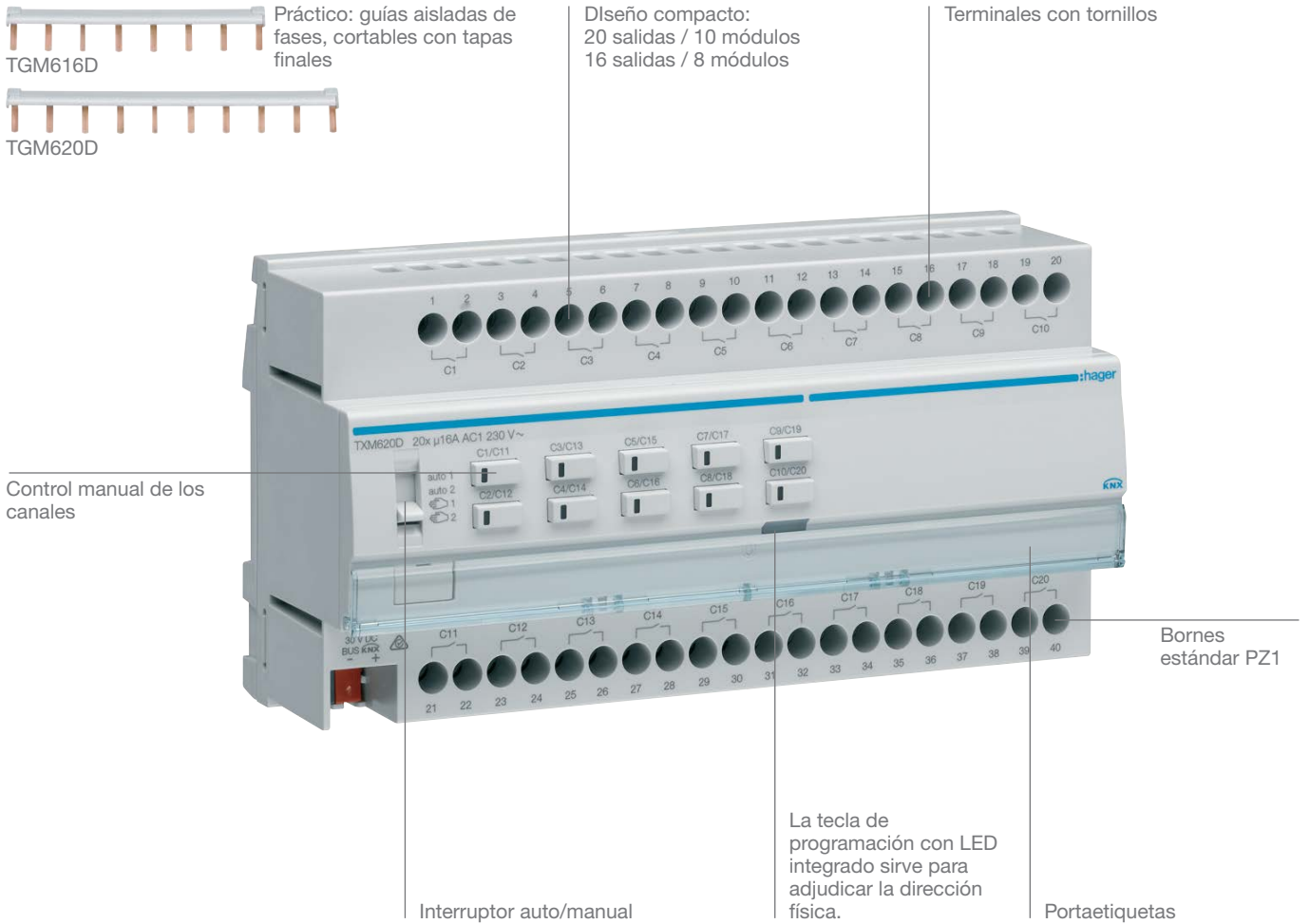

Ventajas:

- Salidas ON / OFF y persianas
- Ocupa poco espacio por su construcción compacta
- Control manual con LED de estado integrado
- Amplio campo para el marcado

Características técnicas:

- Salidas binarias: - 16 y 20 16A carga C
- Espacio necesario: - 16, 8 módulos, 20 salidas, 10 módulos
- Conexión mediante bornes de caja probadas
- Fijación de tornillo PZ1
- Alimentación de tensión solo mediante KNX Bus
- Conexión multifase
- Aplicación: Iluminación y/o persiana/celesía

Especificaciones técnicas salidas binarias

	TXM616D	TXM620D
Modo de instalación	REG	REG
En corriente nominal (A)	16 A Carga C	16 A Carga C
En tensión nominal (V)	250 V / 440 V AC	250 V / 440 V AC
Número de salidas	16	20
Ancho de módulo (PLE)	8	10
Control manual con KNX Bus	sí	sí
Display de estado LED	sí	sí
Ventana de marcado	sí	sí
Medición de corriente	no	no
Tensión de alimentación	30 V DC SELV	30 V DC SELV
Disipación por minuto	20 W	25 W
Consumo propio típico en el KNX	5 mA	5 mA
Consumo propio en reposo KNX	3 mA	3 mA
Número de impulso máximo con carga plena	6	6
Intensidad máxima de corriente por dispositivo (suma)	176 A	200 A
Función AC1	16 A	16 A
Capacidad de cambio carga C	1500W (200 µF)	1500W (200 µF)
Carga de bombillas con 230 V AC	2300 W	2300 W
Fluorescentes T5/T8:		
- sin compensar	1000 W	1000 W
- con EVG	20 x 36 W	20 x 36 W
- balasto eléctrico convencional	1000 W (130µF)	1000 W (130µF)
Lámparas halógenas de bajo voltaje:		
- transformador inductivo	1500 VA	1500 VA
- transformador electrónico	1500 W	1500 W
Lámpara halógena 230 V	2300 W	2300 W
Lámpara de ahorro eléctrico 230 V	25 x 18 W	25 x 18 W
LED:		
- LED	183 W	183 W
- cantidad máxima lámparas LED/ESL	25	25
Tipo de conexión	PZ1 Borne de caja	PZ1 Borne de caja
Sección de conexión:		
- rígida	0,5 mm ² ... 6 mm ²	0,5 mm ² ... 6 mm ²
- flexible	0,5 mm ² ... 4 mm ²	0,5 mm ² ... 4 mm ²

Diferencia de aplicación ETS de los nuevos actuadores multicanal TXM616D/TXM620D con los productos actuales TYA6xxx

	TXM616D TXM620D	TYA6xxx
Funciones de cambio		
- Función encendido/apagado	sí	sí
- Retardo de encendido/apagado	no	sí
- Apagado de seguridad	no	sí
- Temporizador (interrumpible/relanzable)	sí	sí
- Preaviso de apagado	sí	sí
- Parpadeo	no	sí
- Cierre/abertura ajustables	no (cierre, fijo)	sí
- Preajustes (con 1 ó 2 objetos)	no	sí
- Función de bloqueo (con 1 ó 2 objetos)	no	sí
- Control forzado (2 Bit)	sí	sí
- Modo manual configurable (bloquear/desbloquear/estado)	no	sí
- Display de estado con retardo de envío	no	sí
Función de celosía		
- (véase salidas de persianas/celosías)	sí	sí
Función escena		
- Máx. 64 escenas por salida seleccionables	sí	sí
- Las escenas se pueden guardar pulsando la tecla más tiempo	sí	sí
- Acción ajustable con grabación de escenas	no	sí
- Funciones de escenas Encendido/apagado/parpadeo	sí sin parpadeo en	sí
Funciones especiales		
- Objeto "Reiniciar a parámetros ETS"	no	sí
- Display de los LEDs de los dispositivos bloqueable	no	sí
- Acción cuando fallo/vuelta tensión bus	no (mantener estado, fijo)	sí
- Acción durante/después de download ETS	no (mantener estado, fijo)	sí

* solo TYA606E



Módulos de salidas

Denominación	Ref.
Módulo de salidas, 16/8, 16 A, carga C	TXM616D

TXM616D



Denominación	Ref.
Módulo de salidas, 20/10, 16 A carga C	TXM620D

TXM620D



Módulo de persianas

Denominación	Ref.
Módulo de persianas, 12, 230 V	TXM632C

TXM632C

Conexión:
TXM616D

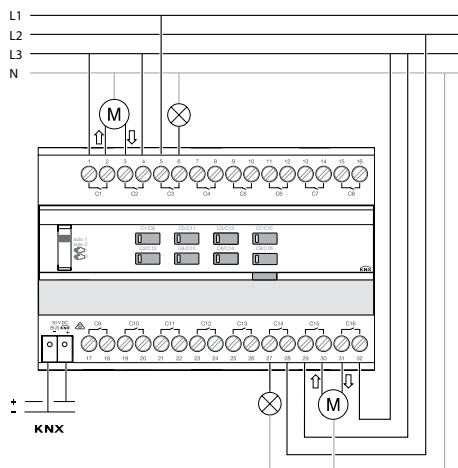

Conexión:
TXM632C

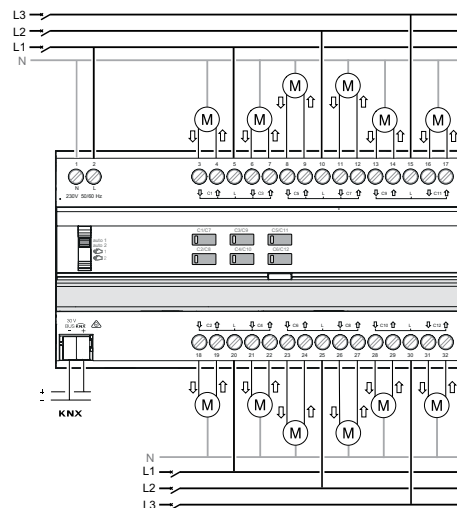

	VDE certificado, todos los artículos de la serie Berker para la cual este certificado es posible, llevan esta marca.	RAL	Determinación de graduaciones de color del Deutsches Institut für Gütesicherung und Kennzeichnung e.V. (Instituto Alemán para la Certificación y Seguridad de la Calidad)	Designaciones / símbolos de aplicación		Lámpara incandescente	
	Países bajos	EDV	Procesamiento electrónico de datos, designado para circuitos especiales por placa central roja Warenzeichen/Marken		Lámpara fluorescente		Lámpara halógena de 12 V
	Austria		Marca registrada de SCHUKO -Warenzeichenverband (Asociación de marca registrada SCHUKO) e.V.; designa tomas de corriente de acuerdo a DIN VDE 0620-1 y DIN 49440. Los terminales también sirven como conectores.		Lámpara halógena de 230 V		Transformador electrónico
	Noruega		Marca registrada de Warenzeichenverband EDELSTAHL ROSTFREI (Asociación de marcas registradas de acero inoxidable).		Transformador convencional		Caja de pared hueca
	Francia		Marca registrada de la Asociación KNX cvba, Bruselas		Designación para -25°C a 40°C de rango de temperatura.	AX	X= lámpara fluorescente – corriente nominal
	Dinamarca		Marca registrada de PERILEX-Gemeinschaft e.V.		Ver pág. 62		Controlador de empotrar, altura de la instalación 1,1 m.
	Italia		Tipos / Clases de protección		Controlador de empotrar, altura de la instalación 2,5 m.		UP-Wächter Montagehöhe 2,2 m.
	Suecia		Sello de supresión de radio VDE		Relé con microcontacto Diámetro de apertura		Elemento de circuito semiconductor
	Canadá		Aislamiento protección clase 2		Tierra		Características del material
	Bélgica	IP	(protección internacional) Designado según DIN40050, IEC60529, la clase de protección de un dispositivo para prevenir el ingreso de objetos extraños y humedad				Los productos series berker no contienen ningún material hecho de PVC o halógeno, con la excepción de la membrana de sellado y el deslizador en la gama de superficie protegida de salpicaduras, así como las cajas de pared del sistema integrado.
	USA	IP44	Protección contra el contacto entre partes y cables energizados o similares de más de 1 mm de diámetro y salpicaduras de agua desde todas direcciones (protegido de contacto desde 1 mm, protegido de salpicaduras).				Deslizador sin halógeno bajo petición
	Polonia	IP55	Protección contra depósitos de polvo dañinos y contra chorros de agua desde una boquilla dirigida hacia la vivienda desde todas las direcciones (protegidos contra el polvo y chorros de agua).				
	Finlandia	IP66	Protección contra depósitos de polvo y chorros de agua fuertes procedentes de todas direcciones (resistente al polvo, resistente al agua).				
	Suiza		Protección Clase III				Las especificaciones técnicas que se dan aquí no son vinculantes. El manual de instrucciones suministrado con los productos se debe consultar en todos los casos.
	ENEC significa Certificación Eléctrica de Normas Europeas. El número que sigue a la marca representa la entidad certificadora. Por ejemplo, VDE:10		Protección de explosiones, zona 11				Las ilustraciones, en especial en lo que respecta al color, tamaño, equipamiento, características de rendimiento de los productos, así como esquemas de conexiones / circuitos, no son vinculantes. Nos reservamos el derecho de realizar modificaciones técnicas y formales en nuestros productos, en virtud del avance técnico.
	Verificación de una mayor tensión con capacidad de soporte para la conexión de dispositivos a la norma DIN 49400 y 49441, equipos de instalación hechos con material a prueba de golpes para un mayor condicionamiento de tensión mecánica		IP44 – compatible, clase de protección IP44 sólo se puede obtener si se usa el kit de sellado adecuado.				
SV	Fuente de alimentación de seguridad (unidad diesel VDE 0107:1994-10), designada por la placa central verde						
ZSV	Fuente de alimentación adicional de seguridad (batería apoyado VDE 0170:1994-10), designada por la placa verde central						
	Muebles construcción / instalación. Los dispositivos pueden montarse en superficies con propiedades inflamables desconocidas..						
	Resistente a las llamas según VDE 0606 T1: 1984-1911, cumple con los requisitos de la VdS (Asociación de Aseguradores de la Propiedad) para el montaje en madera.						
CE	Todos los artículos de este catálogo que estén bajo las regulaciones de la CE llevan la marca CE en la etiqueta de embalaje y en el propio producto.						

Interruptores series berker

Acabado mate

Blanco polar	RAL 9010
Antracita	RAL 7021
Antracita (B.7)	RAL 9005
Negro	RAL 9005
Rojo	RAL 3003
Marrón	RAL 8017

Acabado brillo

Blanco	RAL 1013
Blanco polar	RAL 9010
Rojo	RAL 3003
Negro	RAL 9005
Negro (1930, Glas, Palazzo, R.Classic)	RAL 8022
Marrón	RAL 8011
Gris	RAL 7038

Acabado lacado

Blanco polar, mate	RAL 9010
Antracita, mate	RAL 7021
Aluminio, mate (B.7)	RAL 9006
Cromo, mate (Integro)	RAL 9006
Acero (Integro)	RAL 9022

- Acabado de las tapas

Cristal pulido, reverso impreso

Blanco polar (B.7, B.IQ, TS, TS Crystal, TS Sensor)	RAL 9010
Negro (B.7, B.IQ, TS Sensor)	RAL 9005
Aluminio (B.7, TS Sensor)	RAL 9006

Porcelana, brillo

Blanco polar (Serie 1930 Porzellan made by Rosenthal)	RAL 9010
Negro (Serie 1930 Porzellan made by Rosenthal)	RAL 8022

Acabados aluminio anodizado

Negro (B.3)
Marrón (B.3)
Rojo (B.3)
Dorado (B.3)

Cristal

Blanco polar (R.1/R.3/R. Classic)	RAL 9010
Negro (R.1/R.3/R.Classic)	RAL 9005
Cristal claro (Serie Glas)	
Espejo de cristal (TS Crystal Ball)	
SWAROVSKI® ELEMENTS (TS Crystal Ball)	

Plástico Duro-Horn®, brillo

Blanco, mármol (Palazzo)
Negro, mármol (Palazzo)
Madera, mármol (Palazzo)
Plástico metalizado, oro de 24 kilates (Palazzo)

Metales*

Aluminio anodizado E6EV1 (K.5)
Aluminio anodizado natural (R.1/R.3)
Aluminio ligero acabado en bronce (berker Arsys)
Aluminio dorado (Arsys)
Cobre, aleación de metal (Arsys Cooper Med)
Acero inoxidable (metal cepillado)
Acero inoxidable, níquel cepillado (TS Sensor)
Metal refinado (Palazzo)
Latón barnizado (Palazzo)
Latón cromado (Palazzo)
Latón metal galvanizado, cromo (pulsador TS, TS Crystal)
Latón metal galvanizado, Oro (24k) brillo (pulsador TS, TS Crystal)
Latón metal galvanizado, Oro (24k) brillo (pulsador TS, TS Crystal)

Nota:

Los colores son aproximados a los RAL indicados en esta página.

- Los elementos individuales que por razones técnicas no pueden ser cubiertos, se lacan.

Soluciones exclusivas: **Manufaktur**

berker Manufaktur es el servicio de Hager que nos ofrece la posibilidad de personalizar al máximo nuestro mecanismo hasta convertirlo en una pieza única.

Más información en:
hager.es/berker



:hager

Servicios

Servicios

pág.

berker Manufaktur	286
-------------------	-----

índice de referencias	288
-----------------------	-----

condiciones de venta	303
----------------------	-----

mapa delegaciones y direcciones	305
---------------------------------	-----

berker Manufaktur interruptores exclusivos

En Berker Manufaktur, todos nuestros productos pueden imprimirse o fabricarse en materiales de alta gama. Y les aplicamos numerosos tratamientos únicos y específicos. El objetivo último es llegar a una solución exclusiva.



berker B.IQ,
con símbolos serigrafiados en láser



berker TS,
latón marrón



berker TS,
cristal negro, con toma
de corriente



berker R.classic,
crystal Polarwit

berker Manufaktur teclados personalizados

Diferentes textos y símbolos predefinidos permiten la personalización de algunos teclados como berker TS Sensor confiriendo a sus pantallas táctiles una estética exclusiva y funcionalidades claras.



berker TS Sensor con indicación gráfica de la temperatura, fondo en gris oscuro, textos en gris claro.
berker TS Sensor Manufaktur realizado en colaboración con los arquitectos Sauerbruch Hutton para el proyecto Cologne Oval Offices.

Visita nuestro configurador online:
<http://configurador.hager.es>

Tabla de correspondencia

Referencia - Precio - Página tarifa



Referencia	Precio €	Pág. tarifa	Referencia	Precio €	Pág. tarifa	Referencia	Precio €	Pág. tarifa
1001 01	24,38	144	1011 23 54	27,43	126	1012 21 89	4,01	126
1001 09	24,38	144	1011 23 59	27,43	126	1012 22 04	79,45	128
1001 20 04	55,00	143	1011 23 64	27,43	126	1012 22 09	52,97	128
1001 20 14	55,00	143	1011 23 69	27,43	126	1012 22 14	79,45	128
1001 20 45	16,54	143	1011 23 74	54,78	126	1012 22 16	52,97	128
1001 20 55	33,85	143	1011 23 79	54,78	126	1012 22 25	10,70	128
1001 20 74	45,00	143	1011 23 84	44,93	126	1012 22 35	10,70	128
1001 20 83	33,85	143	1011 23 89	45,78	126	1012 22 45	6,56	128
1001 20 84	45,00	143	1011 30 01	16,32	71	1012 22 69	9,78	128
1001 20 89	16,54	143	1011 30 04	11,37	71	1012 22 74	70,62	128
1004 90 04	12,65	118	1011 30 05	16,32	71	1012 22 79	9,78	128
1004 90 11	12,65	118	1011 30 12	16,32	71	1012 22 84	70,62	128
1005 00 01	8,98	118	1011 30 16	16,32	71	1012 22 89	4,01	128
1005 00 02	6,02	118	1011 30 21	16,32	71	1012 23 34	48,43	127
1005 00 69	6,02	118	1011 30 22	16,32	71	1012 23 39	48,43	127
1005 70 03	10,51	107	1011 30 25	16,32	71	1012 23 44	48,43	127
1005 70 04	10,51	107	1011 30 46	16,32	71	1012 23 49	48,43	127
1005 70 06	7,45	107	1011 36 06	45,00	72	1012 23 54	48,43	126
1005 70 09	6,31	107	1011 36 09	45,00	72	1012 23 59	48,43	126
1009 20	27,95	147	1011 39 04	11,37	71	1012 23 64	48,43	126
1009 21	27,95	147	1011 60 12	4,83	88	1012 23 69	48,43	126
1009 14 04	14,20	75	1011 60 14	10,67	88	1012 23 74	98,48	126
1009 14 14	17,54	75	1011 60 16	10,67	88	1012 23 79	98,48	126
1009 16 06	11,10	75	1011 60 19	4,83	88	1012 23 84	73,56	126
1009 16 16	14,48	75	1011 60 20	30,00	90	1012 23 89	73,11	126
1009 19 09	8,57	75	1011 60 30	30,00	90	1012 30 01	26,52	71
1009 19 19	11,53	75	1011 60 62	1,73	88	1012 30 04	18,48	71
1009 20 35	17,55	143	1011 60 74	30,00	90	1012 30 05	26,52	71
1009 20 45	8,78	130	1011 60 76	23,00	90	1012 30 12	26,52	71
1009 20 79	17,55	143	1011 60 79	23,00	90	1012 30 16	26,52	71
1009 20 89	8,24	130	1011 60 82	1,63	88	1012 30 21	26,52	71
1009 60 72	12,14	93	1011 60 83	30,00	90	1012 30 22	26,52	71
1009 60 74	14,21	93	1011 60 84	4,72	88	1012 30 25	26,52	71
1009 60 76	14,21	93	1011 60 86	4,72	88	1012 30 46	26,52	71
1009 60 79	12,14	93	1011 60 89	1,63	88	1012 36 06	79,45	72
1009 60 82	9,89	93	1011 60 89C	4,72	88	1012 36 09	79,45	72
1009 60 84	19,35	93	1011 60 92	2,46	89	1012 39 04	18,48	71
1009 60 86	19,35	93	1011 60 94	4,72	89	1012 60 12	27,63	88
1009 60 89	9,89	93	1011 60 96	4,72	89	1012 60 14	31,40	88
1009 89 12	10,40	75	1011 60 99	2,46	89	1012 60 16	31,40	88
1009 89 19	10,40	75	1011 61 82	3,00	90	1012 60 19	27,63	88
1009 89 82	8,26	75	1011 61 84	4,00	90	1012 60 20	52,97	90
1009 89 89	8,26	75	1011 61 86	4,00	90	1012 60 30	52,97	90
1010 00	10,75	117	1011 61 89	3,00	90	1012 60 62	3,37	88
1010 70 00	16,10	91, 102	1011 64 14	23,77	72	1012 60 74	52,97	90
1010 71 00	11,11	91, 102	1011 64 24	4,72	72	1012 60 76	40,61	90
1010 72 00	6,75	91, 102	1011 66 16	23,77	72	1012 60 79	40,61	90
1010 76 00	6,44	128	1011 66 26	5,55	72	1012 60 82	3,06	88
1010 77 00	10,14	128	1011 69 04	40,00	72	1012 60 83	52,97	90
1010 78 00	10,00	128	1011 69 09	23,77	72	1012 60 84	6,85	88
1011 20 04	45,00	142	1011 69 14	40,00	72	1012 60 86	6,85	88
1011 20 09	30,00	142	1011 69 19	3,82	72	1012 60 89	3,06	88
1011 20 14	45,00	142	1011 89 12	5,20	70	1012 60 89C	6,85	88
1011 20 16	30,00	142	1011 89 19	5,20	70	1012 60 92	3,06	89
1011 20 45	5,45	142	1011 89 62	5,51	70	1012 60 94	6,85	89
1011 20 74	35,00	142	1011 89 82	1,02	70	1012 60 96	6,85	89
1011 20 84	35,00	142	1011 89 89	1,02	70	1012 60 99	3,06	89
1011 20 89	5,45	142	1011 99 09	1,12	70	1012 61 82	4,37	90
1011 21 04	45,00	126	1011 99 19	5,61	70	1012 61 84	6,25	90
1011 21 09	30,00	126	1011 99 39	1,95	70	1012 61 86	6,25	90
1011 21 14	45,00	126	1011 99 49	4,60	70	1012 61 89	4,37	90
1011 21 16	30,00	126	1011 99 59	14,95	70	1012 64 14	44,37	72
1011 21 35	7,43	127	1011 99 69	23,46	70	1012 64 24	7,41	72
1011 21 45	4,55	126	1012 20 04	109,51	142	1012 66 16	44,37	72
1011 21 74	40,00	126	1012 20 09	59,40	142	1012 66 26	8,49	72
1011 21 79	6,52	127	1012 20 14	109,51	142	1012 69 04	70,62	72
1011 21 84	40,00	126	1012 20 16	59,40	142	1012 69 09	44,37	72
1011 21 89	2,43	126	1012 20 45	15,42	142	1012 69 14	70,62	72
1011 22 04	45,00	128	1012 20 74	59,40	142	1012 69 19	5,57	72
1011 22 09	30,00	128	1012 20 84	59,40	142	1012 89 12	9,49	70
1011 22 14	45,00	128	1012 20 89	15,42	142	1012 89 19	9,49	70
1011 22 16	30,00	128	1012 21 04	79,45	126	1012 89 62	9,79	70
1011 22 35	7,43	128	1012 21 09	52,97	126	1012 89 82	1,63	70
1011 22 45	4,55	128	1012 21 14	79,45	126	1012 89 89	1,63	70
1011 22 74	40,00	128	1012 21 16	52,97	126	1012 99 09	1,73	70
1011 22 79	6,52	128	1012 21 25	10,70	127	1012 99 19	9,69	70
1011 22 84	40,00	128	1012 21 35	10,70	127	1012 99 39	3,02	70
1011 22 89	2,43	128	1012 21 45	6,56	126	1012 99 49	7,11	70
1011 23 34	27,43	127	1012 21 69	9,49	127	1012 99 59	24,85	70
1011 23 39	27,43	127	1012 21 74	70,62	126	1012 99 69	40,52	70
1011 23 44	27,43	127	1012 21 79	9,78	127	1013 20 04	158,85	142
1011 23 49	27,43	127	1012 21 84	70,62	126	1013 20 09	86,17	142

Referencia	Precio €	Pág. tarifa	Referencia	Precio €	Pág. tarifa	Referencia	Precio €	Pág. tarifa
1013 20 14	158,85	142	1013 69 04	78,42	72	1014 89 82	5,81	70
1013 20 16	86,17	142	1013 69 09	71,99	72	1014 89 89	5,81	70
1013 20 45	23,60	142	1013 69 14	80,89	72	1014 99 09	6,22	70
1013 20 74	86,17	142	1013 69 19	9,59	72	1014 99 39	9,85	70
1013 20 84	86,17	142	1013 89 12	14,89	70	1014 99 49	25,51	70
1013 20 89	23,60	142	1013 89 19	14,89	70	1015 21 04	247,66	126
1013 21 04	132,85	126	1013 89 62	14,08	70	1015 21 09	130,01	126
1013 21 09	69,74	126	1013 89 82	3,16	70	1015 21 14	247,66	126
1013 21 14	132,85	126	1013 89 89	3,16	70	1015 21 16	128,32	126
1013 21 16	68,84	126	1013 99 09	3,26	70	1015 21 45	23,92	126
1013 21 25	17,23	127	1013 99 19	16,12	70	1015 21 74	149,99	126
1013 21 35	17,23	127	1013 99 39	6,09	70	1015 21 84	143,70	126
1013 21 45	10,56	126	1013 99 49	13,38	70	1015 21 89	16,20	126
1013 21 69	10,63	127	1013 99 59	40,12	70	1015 22 04	247,66	128
1013 21 74	80,46	126	1013 99 69	67,39	70	1015 22 09	130,01	128
1013 21 79	10,63	127	1014 21 04	181,71	126	1015 22 14	247,66	128
1013 21 84	77,09	126	1014 21 09	95,39	126	1015 22 16	128,32	128
1013 21 89	7,08	126	1014 21 14	181,71	126	1015 22 45	23,92	128
1013 22 04	132,85	128	1014 21 16	94,16	126	1015 22 74	149,99	128
1013 22 09	69,74	128	1014 21 45	17,12	126	1015 22 84	143,70	128
1013 22 14	132,85	128	1014 21 74	110,05	126	1015 22 89	16,20	128
1013 22 16	68,84	128	1014 21 84	105,44	126	1015 23 34	150,96	127
1013 22 25	17,23	128	1014 21 89	9,88	126	1015 23 39	150,96	127
1013 22 35	17,23	128	1014 22 04	181,71	128	1015 23 44	150,96	127
1013 22 45	10,56	128	1014 22 09	95,39	128	1015 23 49	150,96	127
1013 22 69	10,63	128	1014 22 14	181,71	128	1015 23 54	150,96	126
1013 22 74	80,46	128	1014 22 16	94,16	128	1015 23 59	150,96	126
1013 22 79	10,63	128	1014 22 45	17,12	128	1015 23 64	150,96	126
1013 22 84	77,09	128	1014 22 74	110,05	128	1015 23 69	150,96	126
1013 22 89	7,08	128	1014 22 84	105,44	128	1015 30 01	68,54	71
1013 23 34	80,98	127	1014 22 89	9,88	128	1015 30 04	47,71	71
1013 23 39	80,98	127	1014 23 34	110,76	127	1015 30 05	68,54	71
1013 23 44	80,98	127	1014 23 39	110,76	127	1015 30 12	68,54	71
1013 23 49	80,98	127	1014 23 44	110,76	127	1015 30 16	68,54	71
1013 23 54	80,98	126	1014 23 49	110,76	127	1015 30 21	68,54	71
1013 23 59	80,98	126	1014 23 54	110,76	126	1015 30 22	68,54	71
1013 23 64	80,98	126	1014 23 59	110,76	126	1015 30 25	68,54	71
1013 23 69	80,98	126	1014 23 64	110,76	126	1015 30 46	68,54	71
1013 23 74	142,31	126	1014 23 69	110,76	126	1015 36 06	190,00	72
1013 23 79	142,31	126	1014 30 01	55,49	71	1015 36 09	190,00	72
1013 23 84	105,98	126	1014 30 04	38,63	71	1015 39 04	47,71	71
1013 23 89	105,98	126	1014 30 05	55,49	71	1015 60 12	64,49	88
1013 30 01	36,62	71	1014 30 12	55,49	71	1015 60 14	73,76	88
1013 30 04	25,50	71	1014 30 16	55,49	71	1015 60 16	73,76	88
1013 30 05	36,62	71	1014 30 21	55,49	71	1015 60 19	64,49	88
1013 30 12	36,62	71	1014 30 22	55,49	71	1015 60 62	11,63	88
1013 30 16	36,62	71	1014 30 25	55,49	71	1015 60 74	165,10	90
1013 30 21	36,62	71	1014 30 46	55,49	71	1015 60 76	126,58	90
1013 30 22	36,62	71	1014 36 06	181,71	72	1015 60 79	126,58	90
1013 30 25	36,62	71	1014 36 09	181,71	72	1015 60 82	11,02	88
1013 30 46	36,62	71	1014 39 04	38,63	71	1015 60 83	165,10	90
1013 36 06	132,85	72	1014 60 12	50,49	88	1015 60 84	29,11	88
1013 36 09	132,85	72	1014 60 14	57,51	88	1015 60 86	29,11	88
1013 39 04	25,50	71	1014 60 16	57,51	88	1015 60 89	11,02	88
1013 60 12	38,39	88	1014 60 19	50,49	88	1015 60 89C	29,11	88
1013 60 14	43,83	88	1014 60 62	7,14	88	1015 60 92	11,02	89
1013 60 16	43,83	88	1014 60 74	121,14	90	1015 60 94	29,11	89
1013 60 19	38,39	88	1014 60 76	92,87	90	1015 60 96	29,11	89
1013 60 20	88,57	90	1014 60 79	92,87	90	1015 60 99	11,02	89
1013 60 30	88,57	90	1014 60 82	6,83	88	1015 61 82	18,45	90
1013 60 62	5,10	88	1014 60 83	121,14	90	1015 61 84	24,66	90
1013 60 74	88,57	90	1014 60 84	18,84	88	1015 61 86	24,66	90
1013 60 76	67,90	90	1014 60 86	18,84	88	1015 61 89	18,45	90
1013 60 79	67,90	90	1014 60 89	6,83	88	1015 64 14	129,25	72
1013 60 82	4,90	88	1014 60 89C	18,84	88	1015 64 24	68,34	72
1013 60 83	88,57	90	1014 60 92	6,83	89	1015 66 16	129,25	72
1013 60 84	11,85	88	1014 60 94	18,84	89	1015 66 26	56,00	72
1013 60 86	11,85	88	1014 60 96	18,84	89	1015 69 04	146,17	72
1013 60 89	4,90	88	1014 60 99	6,83	89	1015 69 09	129,25	72
1013 60 89C	11,85	88	1014 61 82	12,12	90	1015 69 14	150,78	72
1013 60 92	4,90	89	1014 61 84	16,21	90	1015 69 19	54,00	72
1013 60 94	11,85	89	1014 61 86	16,21	90	1015 89 62	30,60	70
1013 60 96	11,85	89	1014 61 89	12,12	90	1015 89 82	8,06	70
1013 60 99	4,90	89	1014 64 14	97,92	72	1015 89 89	8,06	70
1013 61 82	7,53	90	1014 64 24	43,58	72	1015 99 09	8,67	70
1013 61 84	10,06	90	1014 66 16	97,92	72	1015 99 39	10,89	70
1013 61 86	10,06	90	1014 66 26	40,00	72	1015 99 49	35,55	70
1013 61 89	7,53	90	1014 69 04	107,25	72	1019 14 04	10,00	78
1013 64 14	71,99	72	1014 69 09	97,92	72	1019 16 06	7,14	78
1013 64 24	38,98	72	1014 69 14	110,63	72	1019 19 09	4,65	78
1013 66 16	71,99	72	1014 69 19	34,00	72	1019 20 45	5,62	132, 143
1013 66 26	13,94	72	1014 89 62	22,03	70	1019 20 89	5,20	132, 143

Tabla de correspondencia

Referencia - Precio - Página tarifa



Referencia	Precio €	Pág. tarifa	Referencia	Precio €	Pág. tarifa	Referencia	Precio €	Pág. tarifa
1019 60 82	6,32	95	1034 00 02	15,81	118	1053 70 04	34,70	102
1019 60 84	7,66	95	1034 00 04	11,83	118	1053 70 06	36,21	102
1019 60 86	7,66	95	1035 01 01	9,28	118	1053 70 09	34,70	102
1019 60 89	6,32	95	1035 01 02	4,90	118	1056 00	3,06	112
1019 89 82	3,77	78	1035 01 69	4,90	118	1057 00	5,71	112
1019 89 89	3,77	78	1035 70 03	10,51	107	1058 00	6,32	112
1021 12	4,69	59	1035 70 04	10,51	107	1061	39,07	59
1021 22	7,34	59	1035 70 06	7,45	107	1064 20	20,50	147
1021 32	12,95	59	1035 70 09	3,37	107	1064 21	20,50	147
1022 36 06	79,45	72	1037	9,49	147	1070 01 01	18,16	119
1022 36 09	79,45	72	1037 01	9,49	147	1070 01 02	21,83	119
1022 60 12	27,63	88	1038 20 45	5,62	132, 143	1070 01 04	20,91	119
1022 60 14	31,40	88	1038 20 89	5,20	132, 143	1077 00 01	13,57	114
1022 60 16	31,40	88	1039 20	6,22	147	1077 00 02	11,73	114
1022 60 19	27,63	88	1039 21	6,22	147	1077 00 69	11,73	114
1022 60 83	52,97	90	1040	16,63	147	1077 01 01	18,43	114
1022 60 92	27,63	89	1040 01	16,63	147	1077 01 02	13,87	114
1022 60 94	27,63	89	1041 16 06	11,63	71	1077 01 04	16,22	114
1022 60 99	27,63	89	1041 19 09	14,58	71	1077 71 03	14,69	104
1022 89 12	9,49	70	1041 70 03	17,56	102	1077 71 04	14,69	104
1022 89 19	9,49	70	1041 70 04	17,56	102	1077 71 06	13,97	104
1022 99 19	10,51	70	1041 70 06	14,69	102	1077 71 09	9,25	104
1022 99 59	24,85	70	1041 70 09	14,51	102	1079 00 01	79,87	115
1022 99 69	43,93	70	1041 89 35	10,09	128	1079 00 02	69,46	115
1023 36 06	132,85	72	1041 89 82	11,32	70	1079 00 69	69,46	115
1023 36 09	132,85	72	1041 89 89	11,32	70, 128	1079 01 01	79,87	115
1023 60 12	38,39	88	1041 99 09	13,76	70	1079 01 02	69,46	115
1023 60 14	43,83	88	1041 99 39	18,50	70	1079 01 69	69,46	115
1023 60 16	43,83	88	1041 99 49	18,50	70	1079 02 01	79,87	115
1023 60 19	38,39	88	1042 16 06	19,89	71	1079 02 02	69,46	115
1023 60 83	88,57	90	1042 19 09	18,16	71	1079 02 69	69,46	115
1023 60 92	38,39	89	1042 70 03	25,13	102	1079 03 01	84,15	115
1023 60 94	38,39	89	1042 70 04	25,13	102	1079 03 02	81,40	115
1023 60 99	38,39	89	1042 70 06	23,15	102	1079 03 04	91,39	115
1023 89 12	14,89	70	1042 70 09	21,98	102	1079 04 01	84,15	115
1023 89 19	14,89	70	1042 89 35	17,32	128	1079 04 02	84,76	115
1023 99 19	16,42	70	1042 89 82	19,99	70	1079 04 04	91,39	115
1023 99 59	40,12	70	1042 89 89	19,99	70, 128	1079 05 01	84,15	115
1023 99 69	68,68	70	1042 99 09	18,26	70	1079 05 02	84,76	115
1024 36 06	181,71	72	1042 99 39	36,37	70	1079 05 04	91,39	115
1024 36 09	181,71	72	1042 99 49	36,37	70	1079 71 03	66,50	104
1024 60 12	50,49	88	1043 16 06	31,52	71	1079 71 04	66,50	104
1024 60 14	57,51	88	1043 19 09	29,17	71	1079 71 06	65,99	104
1024 60 16	57,51	88	1043 70 03	34,70	102	1079 71 09	63,20	104
1024 60 19	50,49	88	1043 70 04	34,70	102	1079 72 03	66,50	104
1024 60 83	121,14	90	1043 70 06	36,21	102	1079 72 04	66,50	104
1025 36 06	190,00	72	1043 70 09	34,70	102	1079 72 06	65,99	104
1025 36 09	190,00	72	1043 89 35	27,11	128	1079 72 09	63,20	104
1025 60 12	64,49	88	1043 89 82	31,52	70	1079 73 03	66,50	104
1025 60 14	73,76	88	1043 89 89	31,52	70, 128	1079 73 04	66,50	104
1025 60 16	73,76	88	1043 99 09	29,38	70	1079 73 06	65,99	104
1025 60 19	64,49	88	1043 99 39	53,36	70	1079 73 09	63,20	104
1025 60 83	165,10	90	1043 99 49	53,36	70	1080 14 04	15,91	75
1029 00 01	10,81	112	1044 00 01	18,46	115	1080 16 06	11,12	75
1029 00 62	11,12	91, 112	1044 00 02	16,93	115	1080 19 09	10,10	75
1029 00 65	11,53	112	1044 00 04	17,75	115	1080 20 45	18,78	130
1029 00 69	9,79	91, 112	1045 00 01	15,10	115	1080 20 89	18,41	130
1029 60 86	10,09	91	1045 00 02	9,79	115	1080 60 82	16,26	93
1029 90 04	19,89	112	1045 00 69	9,79	115	1080 60 84	19,35	93
1029 90 11	19,89	112	1045 01 01	16,32	115	1080 60 86	19,35	93
1030 00 01	16,63	112	1045 01 02	13,86	115	1080 60 89	16,26	93
1030 00 62	15,40	91, 112	1045 01 69	13,36	115	1080 89 82	8,17	75
1030 00 69	10,50	91, 112	1045 70 03	14,38	105	1080 89 89	8,40	75
1030 60 86	17,32	91	1045 70 04	14,38	105	1081 14 04	73,75	75
1030 90 04	29,07	112	1045 70 06	11,32	105	1081 16 06	73,85	75
1030 90 11	29,07	112	1045 70 09	10,10	105	1081 19 09	72,22	75
1031 00 01	22,95	112	1045 71 06	13,57	105	1081 60 82	61,30	93
1031 00 62	22,44	91, 112	1045 71 09	12,52	105	1081 60 84	56,33	93
1031 00 69	12,95	91, 112	1051 60 92	4,83	89	1081 60 86	56,33	93
1031 60 86	27,11	91	1051 60 94	4,83	89	1081 60 89	61,30	93
1031 90 04	44,88	112	1051 60 99	4,83	89	1081 89 82	46,72	75
1031 90 11	44,88	112	1052 60 92	27,63	89	1081 89 89	46,72	75
1033 14 04	10,10	78	1052 60 94	27,63	89	1082 19 09	72,22	75
1033 16 06	7,45	78	1052 60 99	27,63	89	1082 60 82	61,30	93
1033 19 09	5,30	78	1052 70 03	25,13	102	1082 60 84	56,33	93
1033 60 82	3,26	95	1052 70 04	25,13	102	1082 60 86	56,33	93
1033 60 84	7,66	95	1052 70 06	23,15	102	1082 60 89	61,30	93
1033 60 86	7,66	95	1052 70 09	21,98	102	1082 89 82	46,82	75
1033 60 89	3,26	95	1053 60 92	38,39	89	1082 89 89	46,82	75
1033 89 12	4,69	78	1053 60 94	38,39	89	1083 19 09	72,22	75
1033 89 19	4,69	78	1053 60 99	38,39	89	1083 60 82	61,30	93
1034 00 01	16,32	118	1053 70 03	34,70	102	1083 60 84	56,33	93

Referencia	Precio €	Pág. tarifa	Referencia	Precio €	Pág. tarifa	Referencia	Precio €	Pág. tarifa
1083 60 86	56,33	93	1109 19 09	1,73	77	1140 00 69	11,63	118
1083 60 89	61,30	93	1109 19 19	2,79	77	1140 90 04	21,52	118
1083 89 82	46,82	75	1109 60 72	2,34	95	1140 90 11	21,52	118
1083 89 89	46,82	75	1109 60 74	4,68	95	1141 00 01	14,28	118
1084 14 04	15,91	74	1109 60 76	4,68	95	1141 00 02	13,57	118
1084 16 06	11,12	74	1109 60 79	2,34	95	1141 00 69	13,57	118
1084 19 09	9,49	74	1109 60 82	2,34	95	1141 90 04	20,71	118
1084 20 45	18,74	130	1109 60 84	4,40	95	1141 90 11	20,71	118
1084 20 89	18,37	130	1109 60 86	4,40	95	1146 14 04	11,53	74
1084 60 82	16,25	93	1109 60 89	2,34	95	1146 16 06	8,26	74
1084 60 84	19,06	93	1109 89 82	2,30	77	1146 19 09	7,24	74
1084 60 86	19,06	93	1109 89 89	2,00	77	1146 20 45	6,00	130
1084 60 89	16,25	93	1109 90 82	1,84	77	1146 20 89	5,52	130
1084 89 82	8,17	74	1109 90 89	1,84	77	1146 60 82	6,63	93
1084 89 89	8,58	74	1111 00	3,47	59	1146 60 84	8,03	93
1087 00 01	13,26	114	1111 01	4,49	59	1146 60 86	8,03	93
1087 00 02	11,93	114	1111 02	4,49	59	1146 60 89	6,63	93
1087 00 69	11,93	114	1111 03	4,49	59	1146 89 82	5,00	74
1087 01 01	21,62	114	1111 05	4,49	59	1146 89 89	5,00	74
1087 01 02	14,38	114	1111 16	4,49	59	1147 00 01	9,59	114
1087 01 04	20,60	114	1112 18	4,49	59	1147 00 02	7,45	114
1087 71 03	14,69	104	1112 21	4,49	59	1147 00 69	7,45	114
1087 71 04	14,69	104	1124 14 04	10,10	75	1147 70 06	7,75	104
1087 71 06	13,97	104	1124 16 06	7,04	75	1147 70 09	6,94	104
1087 71 09	10,83	104	1124 19 09	5,81	75	1147 90 04	17,44	114
1088 00 01	13,26	114	1124 20 45	4,85	130	1147 90 11	17,44	114
1088 00 02	11,93	114	1124 20 89	4,41	130	1150 00 01	16,83	114
1088 00 69	11,93	114	1124 60 82	3,67	94	1150 00 02	14,99	114
1088 01 01	21,93	114	1124 60 84	6,49	94	1150 00 69	14,99	114
1088 01 02	26,62	114	1124 60 86	6,49	94	1150 10 01	17,14	114
1088 01 04	21,32	114	1124 60 89	3,67	94	1150 10 02	17,14	114
1088 71 03	14,69	104	1124 89 82	2,24	75	1150 10 04	18,36	114
1088 71 04	14,69	104	1124 89 89	2,24	75	1150 14 04	16,10	73
1088 71 06	13,97	104	1130 89 82	5,84	70	1150 16 06	15,60	73
1088 71 09	10,83	104	1130 89 89	5,84	70	1150 19 09	11,02	73
1090	23,46	145	1130 99 09	8,88	70	1150 60 89	15,50	92
1090 09	23,46	145	1130 99 39	18,74	70	1150 71 04	16,32	103
1091	28,05	145	1130 99 49	18,74	70	1150 71 06	15,61	103
1091 09	28,05	145	1134 00 01	29,27	116	1150 71 09	14,62	103
1092 00	33,05	145	1134 00 02	28,46	116	1150 89 82	10,61	73
1092 19	33,05	145	1134 00 04	40,19	116	1150 89 89	10,61	73
1093 00	35,80	145	1134 00 21	35,82	116	1154 00 01	10,30	118
1093 09	35,80	145	1134 00 22	35,82	116	1154 00 02	8,16	118
1094	26,62	145	1134 00 24	41,95	116	1154 00 69	8,16	118
1094 09	26,62	145	1135 00 01	25,42	116	1154 10 01	20,88	118
1095	30,91	145	1135 00 02	21,51	116	1154 10 02	13,57	118
1095 09	30,91	145	1135 00 21	27,18	116	1154 10 04	16,52	118
1096 14 04	15,91	74	1135 00 22	23,24	116	1154 71 03	21,54	107
1096 16 06	11,12	74	1135 00 69	21,51	116	1154 71 04	21,54	107
1096 19 09	9,49	74	1135 00 89	23,24	116	1154 71 06	13,26	107
1096 20 45	18,78	130	1135 70 03	40,19	105	1154 71 09	10,10	107
1096 20 89	18,41	130	1135 70 04	40,19	105	1155 00 01	15,40	118
1096 60 82	16,83	93	1135 70 06	21,63	105	1155 00 02	12,04	118
1096 60 84	19,06	93	1135 70 09	21,51	105	1155 00 69	12,04	118
1096 60 86	19,06	93	1135 72 03	41,95	105	1155 01 01	15,40	118
1096 60 89	16,83	93	1135 72 04	41,95	105	1155 01 02	12,04	118
1096 89 82	8,26	74	1135 72 06	23,44	105	1155 01 69	12,04	118
1096 89 89	8,26	74	1135 72 09	23,24	105	1155 10 01	21,96	118
1102	50,59	145	1137 14 04	21,55	76	1155 10 02	16,52	118
1102 09	50,59	145	1137 14 24	23,24	76	1155 10 04	23,66	118
1108 00 01	2,86	118	1137 16 06	14,03	76	1155 91 04	31,62	118
1108 00 02	2,67	118	1137 16 26	15,79	76	1155 91 11	31,62	118
1108 00 69	2,67	118	1137 19 09	8,88	76	1165 00 01	6,35	115
1108 01 01	2,75	118	1137 19 29	10,65	76	1165 00 02	5,92	115
1108 01 02	2,55	118	1137 20 35	17,88	131	1165 00 69	5,92	115
1108 01 69	2,55	118	1137 20 45	11,34	131	1165 01 01	8,16	115
1108 70 03	5,19	107	1137 20 79	17,47	131	1165 01 02	8,75	115
1108 70 04	5,19	107	1137 20 89	11,27	131	1165 01 04	8,06	115
1108 70 06	4,09	107	1137 60 72	23,24	94	1165 70 03	9,08	105
1108 70 09	2,73	107	1137 60 74	23,24	94	1165 70 04	9,08	105
1108 71 03	4,79	107	1137 60 76	23,24	94	1165 70 06	6,22	105
1108 71 04	4,79	107	1137 60 79	23,24	94	1165 70 09	5,57	105
1108 71 06	3,83	107	1137 60 82	21,51	94	1167 00 01	9,18	115
1108 71 09	2,73	107	1137 60 84	21,51	94	1167 00 02	6,53	115
1108 90 04	8,16	118	1137 60 86	21,51	94	1167 00 69	6,53	115
1108 90 11	9,28	118	1137 60 89	21,51	94	1167 70 03	9,59	105
1108 91 04	8,06	118	1137 89 22	10,65	76	1167 70 04	9,59	105
1108 91 11	9,18	118	1137 89 29	10,65	76	1167 70 06	6,73	105
1109 14 04	3,37	77	1137 89 82	5,84	76	1167 70 09	4,10	105
1109 14 14	2,82	77	1137 89 89	5,84	76	1167 90 04	12,85	115
1109 16 06	2,79	77	1140 00 01	14,28	118	1167 90 11	12,85	115
1109 16 16	2,14	77	1140 00 02	11,63	118	1170 14 04	17,65	78

Tabla de correspondencia

Referencia - Precio - Página tarifa



Referencia	Precio €	Pág. tarifa	Referencia	Precio €	Pág. tarifa	Referencia	Precio €	Pág. tarifa
1170 16 06	13,16	78	1203 16 06	7,70	77	1236 00 69	9,49	120
1170 19 09	8,98	78	1203 19 09	1,94	77	1236 60 89	13,68	97
1170 20 45	12,18	132	1203 20 45	5,62	131, 143	1236 70 09	7,05	109
1170 20 89	11,89	132	1203 20 89	5,20	131, 143	1236 89 82	6,43	80
1170 60 82	7,96	96	1203 60 82	4,69	95	1236 89 89	6,43	80
1170 60 84	12,31	96	1203 60 84	7,66	95	1236 90 04	16,32	120
1170 60 86	12,31	96	1203 60 86	7,66	95	1236 99 09	6,73	80
1170 60 89	7,96	96	1203 60 89	4,69	95	1238 00 02	9,49	120
1170 70 03	14,89	107	1203 89 82	1,94	77	1238 00 69	9,49	120
1170 70 04	14,89	107	1203 89 89	1,94	77	1238 90 04	16,32	120
1170 70 06	11,83	107	1204 00 12	8,26	120	1242 00 02	10,71	120
1170 70 09	9,78	107	1204 00 69	8,26	120	1242 00 69	10,71	120
1181 14 04	18,16	78	1204 60 89	5,92	97	1242 90 04	17,44	120
1181 16 06	16,73	78	1204 70 09	6,20	109	1244 00 02	10,71	120
1181 19 09	12,24	78	1204 89 82	5,71	80	1244 00 69	10,71	120
1181 20 45	14,99	132	1204 89 89	5,71	80	1244 60 89	11,24	97
1181 20 89	14,62	132	1204 90 04	15,20	120	1244 71 09	8,10	109
1181 60 82	9,55	96	1204 99 09	5,92	80	1244 89 82	7,45	80
1181 60 84	13,94	96	1216 00 02	14,28	120	1244 89 89	7,45	80
1181 60 86	13,94	96	1216 00 69	14,28	120	1244 90 04	17,44	120
1181 60 89	9,55	96	1216 60 89	20,08	97	1244 99 09	7,75	80
1181 89 82	8,87	78	1216 70 09	14,30	109	1247 00 04	24,67	115
1181 89 89	8,87	78	1216 89 82	12,85	80	1249 00 02	19,99	120
1182 00 01	16,22	119	1216 89 89	12,85	80	1249 00 69	19,99	120
1182 00 02	14,08	119	1216 90 04	23,56	120	1249 60 89	18,87	97
1182 00 69	14,08	119	1216 99 09	13,26	80	1249 70 09	19,56	109
1182 70 03	17,14	107	1217 00 02	14,69	120	1249 89 82	18,16	80
1182 70 04	17,14	107	1217 00 69	14,69	120	1249 89 89	18,16	80
1182 70 06	13,36	107	1217 60 89	20,06	97	1249 90 04	29,68	120
1182 70 09	11,88	107	1217 70 09	13,67	109	1249 99 09	18,87	80
1182 90 04	23,97	119	1217 89 82	12,85	80	1251 00 02	14,28	120
1182 90 11	23,97	119	1217 89 89	12,85	80	1251 00 69	14,28	120
1184 00 01	14,48	117	1217 90 04	22,34	120	1251 60 89	17,86	97
1184 00 02	11,63	117	1217 99 09	13,26	80	1251 70 09	14,30	109
1184 00 04	14,48	117	1218 00 02	14,79	120	1251 89 82	12,85	80
1184 70 03	10,51	106	1218 00 69	14,79	120	1251 89 89	12,85	80
1184 70 04	10,51	106	1218 60 89	18,70	97	1251 90 04	23,56	120
1184 70 06	7,45	106	1218 71 09	14,30	109	1251 99 09	13,26	80
1184 70 09	6,62	106	1218 89 82	12,85	80	1252 00 02	14,28	120
1185 00 01	12,65	117	1218 89 89	12,85	80	1252 00 69	14,28	120
1185 00 02	9,59	117	1218 90 04	23,56	120	1252 60 89	17,81	97
1185 00 69	9,59	117	1218 99 09	15,91	80	1252 70 09	14,30	109
1190 14 04	7,29	79	1219 00 02	14,79	120	1252 89 82	12,85	80
1190 16 06	4,20	79	1219 00 69	14,79	120	1252 89 89	12,85	80
1190 19 09	3,93	79	1219 60 89	18,14	97	1252 90 04	23,56	120
1190 89 82	3,93	79	1219 70 09	14,30	109	1252 99 09	13,26	80
1190 89 89	3,93	79	1219 89 82	12,85	80	1253 00 02	20,09	120
1196 14 04	10,51	77	1219 89 89	12,85	80	1253 00 69	20,09	120
1196 16 06	7,45	77	1219 90 04	23,56	120	1253 60 89	18,87	97
1196 19 09	6,22	77	1219 99 09	13,26	80	1253 70 09	19,56	109
1196 20 35	18,57	143	1220	3,57	58	1253 89 82	18,26	80
1196 20 45	5,72	131	1221	15,50	146	1253 89 89	18,26	80
1196 20 79	18,57	143	1222	17,03	146	1253 90 04	29,68	120
1196 20 89	5,30	131	1223 00 02	14,79	120	1253 99 09	18,87	80
1196 60 82	6,32	95	1223 00 69	14,79	120	1279	4,18	58
1196 60 84	7,66	95	1223 60 89	18,41	97	1279 02	4,18	58
1196 60 86	7,66	95	1223 71 09	14,30	109	1279 03	4,18	58
1196 60 89	6,32	95	1223 89 82	12,85	80	1280	2,75	58
1196 89 82	4,69	77	1223 89 89	12,85	80	1281	2,75	58
1196 89 89	4,69	77	1223 90 04	23,56	120	1282	2,75	58
1198 14 04	10,10	75	1223 99 09	13,26	80	1283	2,75	58
1198 16 06	6,83	75	1224 00 02	14,79	120	1288 19 09	7,24	79
1198 19 09	6,02	75	1224 00 69	14,79	120	1288 19 19	7,24	79
1198 20 45	5,15	130	1224 90 04	23,56	120	1288 19 29	7,24	79
1198 20 89	5,03	130	1225	7,75	146	1288 19 39	7,24	79
1198 60 82	12,27	94	1225 01	7,75	146	1288 19 49	7,24	79
1198 60 84	12,95	94	1226	17,14	146	1288 19 59	14,31	79
1198 60 86	12,95	94	1227	16,63	146	1288 19 69	7,24	79
1198 60 89	12,27	94	1229	17,34	146	1288 89 12	6,43	79
1198 89 82	3,77	75	1229 02	17,34	146	1288 89 19	6,43	79
1198 89 89	3,77	75	1230	3,57	58	1288 89 22	6,43	79
1201 01 11	7,34	117	1231	3,57	58	1288 89 29	6,43	79
1201 01 12	4,59	117	1232	3,57	58	1288 89 32	6,43	79
1201 01 79	4,59	117	1233 00 02	9,49	120	1288 89 39	6,43	79
1201 70 13	9,89	106	1233 00 69	9,49	120	1288 89 42	6,43	79
1201 70 14	9,89	106	1233 60 89	13,64	97	1288 89 49	6,43	79
1201 70 16	7,45	106	1233 70 09	7,05	109	1288 89 52	14,34	79
1201 70 19	4,95	106	1233 89 82	6,43	80	1288 89 59	14,31	79
1202 00 02	9,38	117	1233 89 89	6,43	80	1288 89 82	6,43	79
1202 00 04	10,61	117	1233 90 04	16,32	120	1288 89 89	6,43	79
1202 00 21	9,18	117	1233 99 09	6,73	80	1298 00 02	9,49	120
1203 14 04	10,90	77	1236 00 02	9,49	120	1298 00 69	9,49	120

Referencia	Precio €	Pág. tarifa	Referencia	Precio €	Pág. tarifa	Referencia	Precio €	Pág. tarifa
1298 60 89	9,18	97	1309 66 26	28,92	72	1343 70 06	13,05	102
1298 70 09	9,57	109	1309 69 04	169,19	72	1343 70 09	7,05	102
1298 89 82	6,43	80	1309 69 09	46,18	72	1344 00 01	45,21	112
1298 89 89	6,43	80	1309 69 14	169,19	72	1344 00 02	45,21	112
1298 90 04	16,32	120	1309 69 19	28,92	72	1344 00 04	42,53	112
1298 99 09	6,73	80	1309 70 03	14,38	102	1353 00 01	14,18	112
1299 00 02	19,99	120	1309 70 04	14,38	102	1353 00 02	12,34	112
1299 00 69	19,99	120	1309 70 06	8,47	102	1353 00 69	12,34	112
1299 60 89	18,87	97	1309 70 09	6,83	102	1353 70 03	59,67	102
1299 71 09	19,56	109	1309 89 82	2,75	70	1353 70 04	59,67	102
1299 89 82	18,26	80	1309 89 89	2,75	70	1353 70 06	18,24	102
1299 89 89	18,16	80	1309 99 09	2,86	70	1353 70 09	11,46	102
1299 90 04	29,68	120	1309 99 39	17,07	70	1354 00 01	66,76	112
1299 99 09	18,87	80	1309 99 49	17,07	70	1354 00 02	66,76	112
1300 00 02	10,40	120	1311	61,61	193	1354 00 04	60,49	112
1300 00 69	10,40	120	1313 00 01	2,35	112	1363 00 01	3,98	112
1300 60 89	11,97	97	1313 00 02	1,84	112	1363 00 02	3,37	112
1300 71 09	8,20	109	1313 00 07	22,87	121	1363 00 07	35,50	121
1300 89 82	7,45	80	1313 00 62	6,12	112	1363 00 62	10,00	112
1300 89 89	7,45	80	1313 00 69	1,84	112	1363 00 69	3,37	112
1300 90 14	17,44	120	1313 70 03	9,49	102	1363 70 03	14,38	102
1300 99 09	7,75	80	1313 70 04	9,49	102	1363 70 04	14,38	102
1301 00 02	10,40	120	1313 70 06	3,47	102	1363 70 06	5,00	102
1301 00 69	10,40	120	1313 70 09	1,79	102	1363 70 09	3,47	102
1301 60 89	11,97	97	1314 00 01	6,12	112	1364 00 01	11,27	112
1301 71 09	8,20	109	1314 00 02	6,12	112	1364 00 02	11,27	112
1301 89 82	7,45	80	1314 00 04	6,94	112	1364 00 04	11,32	112
1301 89 89	7,45	80	1319 19 09	6,51	203	1366	217,87	193
1301 90 04	17,44	120	1319 21 04	62,40	203	1373 00 01	6,73	112
1301 99 09	7,75	80	1319 21 09	45,07	203	1373 00 02	5,30	112
1302 00 02	52,44	120	1319 21 16	45,07	203	1373 00 07	53,67	121
1302 00 69	52,44	120	1319 21 45	6,51	203	1373 00 69	5,30	112
1302 90 04	46,31	120	1319 21 84	62,40	203	1373 70 03	31,21	102
1305 00 02	22,33	120	1319 21 89	6,51	203	1373 70 04	31,21	102
1305 00 69	22,33	120	1319 22 04	90,61	203	1373 70 06	8,05	102
1305 60 89	9,18	97	1319 22 45	6,51	203	1373 70 09	5,15	102
1305 70 09	21,60	109	1319 22 84	90,61	203	1374 00 01	29,35	112
1305 89 82	21,22	80	1319 36 06	90,61	203	1374 00 02	29,35	112
1305 89 89	21,17	80	1319 60 82	6,51	203	1374 00 04	31,42	112
1305 90 04	18,76	120	1319 60 84	6,51	203	1381 01	3,47	144
1305 99 19	21,35	80	1319 60 86	6,51	203	1381 09	3,47	144
1308 00 02	16,62	120	1319 60 89	6,51	203	1381 21	9,79	144
1308 00 69	16,62	120	1319 60 99	6,51	203	1381 29	9,79	144
1308 60 89	13,77	97	1319 64 14	45,07	203	1381 31	14,79	144
1308 89 82	12,85	80	1319 64 24	6,51	203	1381 39	14,79	144
1308 89 89	12,85	80	1319 66 16	45,07	203	1381 41	13,77	144
1308 90 04	27,18	120	1319 69 09	45,07	203	1381 49	13,77	144
1308 99 09	15,91	80	1319 70 06	6,51	203	1381 51	16,12	144
1309 30 01	29,58	71	1319 70 09	6,51	203	1381 59	16,12	144
1309 30 04	26,08	71	1319 89 82	6,51	203	1381 65	38,45	144
1309 30 05	29,58	71	1321	69,05	193	1381 69	38,45	144
1309 30 12	29,58	71	1323 00 01	3,98	112	1383 00 01	9,49	112
1309 30 16	29,58	71	1323 00 02	3,37	112	1383 00 02	7,45	112
1309 30 21	29,58	71	1323 00 07	35,50	121	1383 00 69	7,45	112
1309 30 22	29,58	71	1323 00 62	10,00	112	1383 70 03	37,94	102
1309 30 25	29,58	71	1323 00 69	3,37	112	1383 70 04	37,94	102
1309 30 46	44,88	71	1323 70 03	14,38	102	1383 70 06	13,05	102
1309 36 06	121,01	72	1323 70 04	14,38	102	1383 70 09	7,05	102
1309 36 09	121,01	72	1323 70 06	5,00	102	1384 00 01	45,21	112
1309 39 04	26,08	71	1323 70 09	3,47	102	1384 00 02	45,21	112
1309 60 20	60,00	90	1324 00 01	11,27	112	1384 00 04	42,53	112
1309 60 30	60,00	90	1324 00 02	11,27	112	1388	278,05	193
1309 60 74	60,00	90	1324 00 04	11,32	112	1391	62,83	193
1309 60 76	50,00	90	1331 11	13,24	144	1392	69,05	193
1309 60 79	50,00	90	1331 19	13,24	144	1393 00 01	14,18	112
1309 60 82	6,63	88	1333 00 01	6,73	112	1393 00 02	12,34	112
1309 60 83	60,00	90	1333 00 02	5,30	112	1393 00 69	12,34	112
1309 60 84	6,85	88	1333 00 07	53,67	121	1393 70 03	59,67	102
1309 60 86	6,85	88	1333 00 69	5,30	112	1393 70 04	59,67	102
1309 60 89	6,63	88	1333 70 03	31,21	102	1393 70 06	18,24	102
1309 60 89C	6,85	88	1333 70 04	31,21	102	1393 70 09	11,46	102
1309 60 92	6,63	89	1333 70 06	8,05	102	1394	91,19	193
1309 60 94	6,85	89	1333 70 09	5,15	102	1394 00 01	66,76	112
1309 60 96	6,85	89	1334 00 01	29,35	112	1394 00 02	66,76	112
1309 60 99	6,63	89	1334 00 02	29,35	112	1394 00 04	60,49	112
1309 61 82	7,00	90	1334 00 04	31,42	112	1403 02	7,85	79, 119
1309 61 84	7,00	90	1341	91,19	193	1403 09	7,85	79, 108, 119
1309 61 86	7,00	90	1343 00 01	9,79	112	1403 14 04	14,69	79, 119
1309 61 89	7,00	90	1343 00 02	7,45	112	1403 16 06	10,20	79, 96, 108, 119
1309 64 14	46,18	72	1343 00 69	7,45	112	1403 19 09	7,75	79, 96, 119
1309 64 24	28,92	72	1343 70 03	37,94	102	1404 00 01	5,71	113
1309 66 16	46,18	72	1343 70 04	37,94	102	1404 00 02	5,71	113

Tabla de correspondencia

Referencia - Precio - Página tarifa



Referencia	Precio €	Pág. tarifa	Referencia	Precio €	Pág. tarifa	Referencia	Precio €	Pág. tarifa
1404 00 04	5,71	113	1416 02 01	15,50	113	1463 09	17,85	119
1404 00 10	15,20	114	1416 02 04	17,14	113	1463 14 04	23,26	119
1405 00 01	4,08	113	1417 00 01	6,53	113	1463 16 06	20,09	96, 119
1405 00 02	2,45	113	1417 00 02	5,61	113	1463 19 09	21,51	96, 119
1405 00 07	18,59	121	1417 00 69	5,61	113	1464 02	17,85	119
1405 00 69	2,45	113	1417 71 03	8,77	103	1464 09	17,85	119
1405 70 03	6,53	103	1417 71 04	8,77	103	1464 14 04	23,26	119
1405 70 04	6,53	103	1417 71 06	8,67	103	1464 16 06	20,09	96, 119
1405 70 06	6,43	103	1417 71 09	5,37	103	1464 19 09	21,51	96, 119
1405 70 09	2,32	103	1418 00 01	14,85	113	1465 00 01	12,44	114
1407	13,26	147	1418 00 02	14,85	113	1465 00 02	9,79	114
1407 01	13,26	147	1418 00 04	14,18	113	1465 00 69	9,79	114
1407 00 01	7,65	118	1424 00 01	13,93	113	1465 70 04	17,01	104
1407 00 02	5,30	118	1424 00 02	13,93	113	1465 70 06	11,22	104
1407 00 69	5,30	118	1424 00 04	6,73	113	1465 70 09	17,36	104
1407 14 04	8,20	78	1424 10 04	12,85	117	1465 90 04	27,54	114
1407 16 06	5,80	78	1425 00 01	5,61	113	1465 90 11	27,54	114
1407 19 09	3,77	78	1425 00 02	4,28	113	1468 01	8,77	107, 118
1407 20 45	5,62	132, 143	1425 00 69	4,28	113	1468 02	2,86	118
1407 20 89	5,20	132, 143	1425 71 03	7,65	103	1468 09	2,86	107, 118
1407 60 82	5,10	95	1425 71 04	7,65	103	1469 01	8,77	107, 118
1407 60 84	7,66	95	1425 71 06	7,65	103	1469 02	4,18	118
1407 60 86	7,66	95	1425 71 09	4,20	103	1469 09	4,18	107, 118
1407 60 89	5,10	95	1426 00 01	11,93	113	1470 02	15,07	78, 119
1407 70 03	8,36	107	1426 00 02	9,79	113	1470 09	15,07	78, 108, 119
1407 70 04	8,36	107	1426 00 69	9,79	113	1470 19 09	16,28	78, 96, 119
1407 70 06	5,92	107	1426 70 03	9,59	103	1474 02	6,63	79, 96, 119
1407 70 09	5,25	107	1426 70 04	9,59	103	1474 04	20,60	79, 108, 119
1407 89 82	3,77	78	1426 70 06	9,49	103	1474 09	6,63	79, 108, 119
1407 89 89	3,77	78	1426 70 09	9,15	103	1474 14 04	11,53	79, 96, 119
1408 00 01	9,08	118	1427 02	15,91	118	1474 16 06	8,57	79, 96, 108, 119
1408 00 02	9,08	118	1427 09	15,91	118	1474 19 09	7,24	79, 96, 119
1408 00 04	10,71	118	1427 14 04	20,91	118	1480 02	16,73	78, 119
1409	20,50	147	1427 16 06	17,85	96, 118	1480 09	16,73	78, 108, 119
1409 00 01	9,59	118	1427 19 09	15,91	96, 118	1480 19 09	19,04	78, 96, 119
1409 00 02	6,63	118	1431 02	7,85	79, 119	1483 01	8,87	77, 107, 117
1409 00 69	6,63	118	1431 04	16,42	79, 108, 119	1483 02	3,77	77, 117
1409 01	20,50	147	1431 09	7,85	79, 108, 119	1483 04	13,16	77, 107, 117
1409 14 04	9,90	78	1431 14 04	14,89	79	1483 09	3,77	77, 107, 117
1409 16 06	7,00	78	1431 16 06	11,83	79, 96, 108, 119	1483 11	10,61	77, 107, 117
1409 19 09	5,63	78	1431 19 09	9,33	79, 96, 119	1483 14 04	10,00	77, 117
1409 20 45	5,62	132, 143	1431 70 03	9,33	108	1483 16 06	6,63	77, 95, 107, 117
1409 20 89	5,20	132, 143	1432 20 45	9,20	131	1483 19 09	4,08	77, 95, 107, 117
1409 60 82	5,10	96	1432 20 89	6,48	131	1484 01	8,77	77, 107, 117
1409 60 84	7,66	96	1434 00 01	11,88	114	1484 02	4,08	77, 117
1409 60 86	7,66	96	1434 00 02	11,88	114	1484 04	10,61	77, 107, 117
1409 60 89	5,10	96	1434 00 04	12,14	114	1484 09	4,08	77, 107, 117
1409 70 03	10,51	107	1434 00 07	25,97	121	1484 11	10,61	77, 107, 117
1409 70 04	10,51	107	1434 00 10	21,32	114	1484 14 04	10,00	77, 117
1409 70 06	7,45	107	1434 01 01	15,08	114	1484 16 06	6,63	77, 95, 107, 117
1409 70 09	6,52	107	1434 01 02	16,01	114	1484 19 09	3,98	77, 95, 107, 117
1409 89 82	4,59	78	1434 01 04	15,71	114	1484 20 45	5,62	131, 143
1409 89 89	4,59	78	1434 01 07	32,18	121	1484 20 89	5,20	131, 143
1410 00 01	11,63	118	1435 00 01	8,67	114	1487 00	13,06	113
1410 00 02	11,93	118	1435 00 02	6,63	114	1492 02	16,22	78, 119
1410 00 04	12,95	118	1435 00 69	6,63	114	1492 09	16,22	78, 108, 119
1411 02	7,55	78, 119	1435 01 01	11,53	114	1492 19 09	19,04	78, 96, 119
1411 09	7,55	78, 108, 119	1435 01 02	7,55	114	1493 01	11,96	75, 105
1411 19 09	7,65	78, 96, 119	1435 01 69	7,55	114	1493 02	6,78	75
1412 02	7,96	77, 117	1435 70 03	16,33	103	1493 04	15,91	75, 105
1412 09	7,96	77, 106, 117	1435 70 04	9,18	103	1493 09	6,78	75, 105
1412 14 04	16,32	77, 117	1435 70 06	9,08	103	1493 11	18,18	75, 105
1412 16 06	11,12	77, 95, 106, 117	1435 70 09	6,20	103	1493 14 04	15,91	75
1412 19 09	8,87	77, 95, 106, 117	1435 71 03	11,32	104	1493 16 06	10,44	75, 93, 105
1414 00 10	16,52	114	1435 71 04	11,32	104	1493 19 09	6,78	75, 93, 105
1415 00 01	6,63	113	1435 71 06	11,32	104	1494 02	4,18	78, 119
1415 00 02	5,61	113	1435 71 09	7,36	104	1494 09	4,18	78, 107, 119
1415 00 69	5,61	113	1436 00 01	16,22	113	1494 14 04	10,00	78, 119
1415 02 01	11,53	113	1436 00 02	16,22	113	1494 16 06	6,63	78, 107, 119
1415 02 02	10,91	113	1436 00 04	18,87	113	1494 19 09	4,59	78, 96, 107, 119
1415 02 69	10,91	113	1436 10 04	16,32	117	1495 02	6,43	78, 119
1415 70 03	10,54	103	1437 00 01	10,00	114	1495 09	6,43	78, 108, 119
1415 70 04	10,54	103	1437 00 02	7,65	114	1495 14 04	11,93	78, 119
1415 70 06	7,65	103	1437 00 69	7,65	114	1495 16 06	8,87	78, 108, 119
1415 70 09	5,37	103	1437 70 03	11,32	104	1495 19 09	7,69	78, 96, 108, 119
1415 71 03	13,69	103	1437 70 04	11,32	104	1496 70 03	10,71	103
1415 71 04	10,71	103	1437 70 06	11,32	104	1496 70 04	10,71	103
1415 71 06	10,51	103	1437 70 09	7,47	104	1496 70 06	10,51	103
1415 71 09	9,99	103	1458 01	8,77	78, 107, 118	1496 70 09	10,10	103
1416 00 01	9,93	113	1458 02	3,77	78, 118	1499 00 02	4,64	117
1416 00 02	9,93	113	1458 09	3,77	78, 107, 118	1499 00 04	6,63	117
1416 00 04	10,30	113	1463 02	17,85	119	1499 00 69	4,64	117

Referencia	Precio €	Pág. tarifa	Referencia	Precio €	Pág. tarifa	Referencia	Precio €	Pág. tarifa
1499 01 01	5,42	117	1620 60 46	5,10	92	1626 60 86	9,53	92
1499 14 04	8,80	77	1620 60 49	2,86	92	1626 60 89	8,77	92
1499 16 06	6,43	77	1620 60 52	2,86	92	1626 89 82	5,81	73
1499 19 09	5,20	77	1620 60 54	5,10	92	1626 89 89	5,81	73
1499 89 82	4,59	77	1620 60 56	5,10	92	1627 14 04	9,90	74
1499 89 89	4,59	77	1620 60 59	2,86	92	1627 16 06	7,00	74
1504 00 11	19,79	115	1620 60 62	2,86	92	1627 19 09	8,47	74
1504 00 12	16,63	115	1620 60 64	5,10	92	1627 20 45	8,76	130
1504 00 79	16,63	115	1620 60 66	5,10	92	1627 20 89	7,01	130
1504 71 03	19,79	104	1620 60 69	2,86	92	1627 60 82	12,34	92
1504 71 04	19,79	104	1620 60 82	2,24	92	1627 60 84	18,65	92
1504 71 06	15,10	104	1620 60 84	3,92	92	1627 60 86	18,65	92
1504 71 09	15,35	104	1620 60 86	3,92	92	1627 60 89	12,34	92
1504 90 14	24,68	115	1620 60 89	2,24	92	1627 89 82	7,65	74
1504 90 21	24,68	115	1620 89 82	1,33	73	1627 89 89	7,65	74
1505 00 11	19,69	115	1620 89 89	1,33	73	1628 14 04	10,90	73
1505 00 12	17,75	115	1621 14 04	8,20	73	1628 16 06	8,20	73
1505 00 79	17,75	115	1621 16 06	5,50	73	1628 19 09	7,65	73
1505 70 03	19,79	104	1621 19 09	2,65	73	1628 60 72	9,69	92
1505 70 04	19,79	104	1621 20 35	5,82	129	1628 60 74	14,38	92
1505 70 06	15,10	104	1621 20 45	5,82	129	1628 60 76	14,38	92
1505 70 09	15,35	104	1621 20 79	5,21	129	1628 60 79	9,69	92
1505 90 14	24,99	115	1621 20 89	3,75	129	1628 60 82	9,69	92
1505 90 21	24,68	115	1621 60 72	9,14	92	1628 60 84	14,87	92
1506 14 04	26,21	75	1621 60 74	11,69	92	1628 60 86	14,87	92
1506 16 06	18,97	75	1621 60 76	11,69	92	1628 60 89	9,69	92
1506 19 09	17,03	75	1621 60 79	9,14	92	1628 89 82	6,83	73
1506 20 45	14,80	130	1621 60 82	8,04	92	1628 89 89	6,83	73
1506 20 89	14,80	130	1621 60 84	11,40	92	1632 14 04	24,68	75
1506 60 82	14,79	93	1621 60 86	11,40	92	1632 16 06	17,65	75
1506 60 84	15,27	93	1621 60 89	8,04	92	1632 19 09	15,40	75
1506 60 86	15,27	93	1621 89 82	2,65	73	1632 20 45	18,70	130
1506 60 89	14,79	93	1621 89 89	3,95	73	1632 20 89	18,25	130
1506 89 82	10,40	75	1622 14 04	6,70	73	1632 60 86	20,89	94
1506 89 89	10,40	75	1622 16 06	5,00	73	1632 60 89	15,71	94
1507 14 04	26,21	75	1622 19 09	3,57	73	1632 89 82	8,87	75
1507 16 06	18,97	75	1622 20 45	5,82	129	1632 89 89	8,87	75
1507 19 09	17,03	75	1622 20 89	4,07	129	1633 14 04	24,68	75
1507 20 45	6,77	130	1622 60 82	10,54	92	1633 16 06	17,65	75
1507 20 89	6,77	130	1622 60 84	12,95	92	1633 19 09	15,40	75
1507 60 82	14,79	93	1622 60 86	12,95	92	1633 20 45	18,70	130
1507 60 84	16,09	93	1622 60 89	10,54	92	1633 20 89	18,25	130
1507 60 86	16,09	93	1622 89 82	4,18	73	1633 60 86	20,89	94
1507 60 89	14,79	93	1622 89 89	4,18	73	1633 60 89	15,71	94
1507 89 82	10,40	75	1623 14 04	8,10	74	1633 89 82	8,87	75
1507 89 89	10,40	75	1623 16 06	5,30	74	1633 89 89	8,87	75
1570 14 04	23,49	74	1623 19 09	2,55	74	1634 00 01	19,89	116
1570 16 06	22,15	74	1623 20 45	7,07	129	1634 00 02	24,40	116
1570 19 09	19,70	74	1623 20 89	3,28	129	1634 00 69	24,40	116
1571 14 04	13,74	74	1623 60 82	5,92	92	1634 01 01	40,90	116
1571 16 06	14,73	74	1623 60 84	6,79	92	1634 01 02	40,70	116
1571 19 09	14,88	74	1623 60 86	6,79	92	1634 01 04	47,23	116
1572 14 04	25,42	74	1623 60 89	5,92	92	1634 71 03	17,95	105
1572 16 06	23,97	74	1623 89 82	2,45	74	1634 71 04	17,95	105
1572 19 09	23,78	74	1623 89 89	2,45	74	1634 71 06	16,01	105
1573 14 04	23,11	74	1624 14 04	8,30	73	1634 71 09	16,30	105
1573 16 06	21,91	74	1624 16 06	5,80	73	1635 00 01	19,89	116
1573 19 09	21,32	74	1624 19 09	7,14	73	1635 00 02	17,44	116
1577 14 04	24,59	74	1624 20 45	5,82	129	1635 00 69	17,44	116
1577 16 06	23,66	74	1624 20 89	5,21	129	1635 01 01	40,90	116
1577 19 09	23,07	74	1624 60 82	8,79	92	1635 01 02	40,70	116
1600	8,57	60	1624 60 84	11,49	92	1635 01 04	47,23	116
1600 02	7,24	60	1624 60 86	11,49	92	1635 71 03	17,95	105
1601	5,30	58	1624 60 89	8,79	92	1635 71 04	17,95	105
1605 10	3,16	60	1624 89 82	5,20	73	1635 71 06	16,01	105
1605 14	3,16	60	1624 89 89	5,20	73	1635 71 09	16,30	105
161	24,79	63	1625 14 04	11,80	74	1640 14 04	55,00	74
1610 03	8,36	58	1625 16 06	9,20	74	1640 16 06	30,00	74
1610 13	8,36	58	1625 19 09	5,92	74	1640 19 09	9,89	74
1620 14 04	5,80	73	1625 20 45	8,76	130	1640 20 45	66,43	131
1620 16 06	2,70	73	1625 20 89	4,08	130	1640 20 89	66,23	131
1620 19 09	1,43	73	1625 60 82	6,63	92	1640 60 82	39,98	93
1620 20 15	5,82	129	1625 60 84	9,14	92	1640 60 84	40,71	93
1620 20 25	5,82	129	1625 60 86	9,14	92	1640 60 86	40,71	93
1620 20 35	5,82	129	1625 60 89	6,63	92	1640 60 89	39,98	93
1620 20 45	4,98	129	1625 89 82	5,30	74	1640 60 92	72,25	94
1620 20 59	2,71	129	1625 89 89	5,30	74	1640 60 94	74,66	94
1620 20 69	2,71	129	1626 14 04	10,00	73	1640 60 96	74,66	94
1620 20 79	2,71	129	1626 16 06	7,20	73	1640 60 99	72,25	94
1620 20 89	2,32	129	1626 19 09	6,63	73	1640 89 82	8,87	74
1620 60 42	2,86	92	1626 60 82	8,77	92	1640 89 84	73,97	76
1620 60 44	5,10	92	1626 60 84	9,53	92	1640 89 89	8,87	74

Tabla de correspondencia

Referencia - Precio - Página tarifa



Referencia	Precio €	Pág. tarifa	Referencia	Precio €	Pág. tarifa	Referencia	Precio €	Pág. tarifa
1640 89 92	72,50	76	1719 00 01	6,88	113	1738 90 11	297,82	116
1640 89 99	72,50	76	1719 00 02	5,14	113	1765 00 01	44,05	116
1640 99 06	73,00	76	1719 00 11	6,98	113	1765 00 02	39,16	116
1640 99 09	72,50	76	1719 00 14	7,80	113	1765 00 04	48,90	116
1641 00 01	11,22	114	1719 00 69	5,14	113	1765 00 11	48,37	116
1641 00 02	10,20	114	1719 14 04	5,55	73	1765 00 12	48,37	116
1641 00 69	10,20	114	1719 16 06	4,40	73	1765 00 69	39,16	116
1641 71 03	31,93	104	1719 19 09	4,12	73	1765 14 04	41,87	76
1641 71 04	31,93	104	1719 19 12	4,20	73	1765 16 06	36,89	76
1641 71 06	29,07	104	1719 20 22	3,79	129	1765 19 09	34,67	76
1641 71 09	17,24	104	1719 20 45	4,56	129	1765 60 86	124,66	94
1641 71 14	78,81	106	1719 20 89	3,72	129	1765 60 89	124,66	94
1641 71 16	74,82	106	1719 60 12	4,24	91	1765 70 03	48,90	105
1641 71 19	73,11	106	1719 60 72	4,16	91	1765 70 04	48,90	105
1641 71 34	78,81	106	1719 60 74	5,83	91	1765 70 06	39,61	105
1641 90 04	27,85	114	1719 60 86	5,83	91	1765 70 09	39,16	105
1641 90 11	27,85	114	1719 60 89	4,16	91	1765 89 82	34,67	76
1647	10,20	146	1719 70 03	8,71	103	1765 89 89	34,67	76
1647 01	10,20	146	1719 70 04	8,71	103	1800	4,08	55
1647 65	62,88	144	1719 70 06	4,94	103	1809	12,67	193
1647 69	35,90	144	1719 70 09	4,81	103	1811 10	30,22	193
1651 19 49	8,98	74	1719 70 15	4,91	103	1811 12	37,43	193
1651 19 59	8,98	74	1719 89 12	3,90	73	1811 13	42,94	193
1651 19 69	8,98	74	1719 89 82	3,82	73	1812	33,66	146
1651 20 49	22,93	130	1719 89 89	3,82	73	1812 01	39,17	146
1651 20 69	22,89	130	1720 20 45	18,37	129	1813	1,28	144, 156
1651 20 89	22,89	130	1720 20 89	16,17	129	1813 05	1,84	144, 156
1651 60 49	17,39	93	1720 60 82	11,37	91	1813 09	1,84	144, 156
1651 60 59	17,32	93	1720 60 84	11,15	91	1817 05	3,57	144, 156
1651 71 09	10,30	104	1720 60 86	11,15	91	1817 09	3,57	144, 156
1651 72 09	10,30	104	1720 60 89	11,37	91	1818	34,78	59
1651 73 09	10,30	104	1720 72 03	17,78	103	1818 01	41,82	59
1661 19 49	10,10	74	1720 72 04	17,78	103	1823 05	2,96	144
1661 20 49	29,94	130	1720 72 06	11,37	103	1823 09	2,96	144
1661 60 49	19,40	93	1720 72 09	11,15	103	1824	16,25	193
1661 71 09	11,15	104	1735 00 01	159,82	116	1849	1,12	59
1665 14 04	13,90	74	1735 00 02	149,75	116	1861	2,86	55, 146
1665 16 06	11,80	74	1735 00 69	149,75	116	1861 01	2,30	143
1665 19 09	9,49	74	1735 14 04	159,17	76	1870	25,28	194
1665 60 89	8,77	92	1735 16 06	153,29	76	1871	25,28	194
1665 89 82	8,36	74	1735 19 09	149,50	76	1887	0,89	147
1665 89 89	8,36	74	1735 60 86	107,56	94	1895 10	8,88	193
1674 14 04	23,24	76	1735 60 89	149,75	94	1895 12	8,90	193
1674 16 06	15,79	76	1735 70 03	172,45	105	1895 13	9,70	193
1674 19 09	10,65	76	1735 70 04	172,45	105	1905 00 02	3,67	78, 118
1674 60 89	19,53	94	1735 70 06	153,29	105	1905 00 69	3,67	78, 95, 107, 118
1674 89 82	10,65	76	1735 70 09	149,75	105	1905 70 03	6,07	107
1674 89 89	10,65	76	1735 89 82	149,50	76	1905 70 04	6,07	78, 107, 118
1675	3,16	60	1735 89 89	149,50	76	1905 80 01	8,20	57
1675 04	5,10	60	1735 90 04	172,45	116	1905 80 02	8,20	57
1676	6,32	60	1735 90 11	172,45	116	1905 80 03	8,20	57
1676 01	6,32	60	1736 00 01	239,00	116	1905 80 04	8,20	57
1676 02	6,32	60	1736 00 02	228,93	116	1905 80 05	8,20	57
1676 03	10,20	60	1736 00 69	228,93	116	1905 80 06	8,20	57
1678	14,80	58	1736 14 04	238,34	76	1905 80 07	8,20	57
1678 01	9,59	58	1736 16 06	232,46	76	1905 80 08	8,20	57
1678 02	9,59	58	1736 19 09	228,71	76	1905 80 09	8,20	57
1678 03	21,38	58	1736 60 86	163,12	94	1905 80 10	8,20	57
1678 04	14,06	58	1736 60 89	228,93	94	1905 80 11	9,20	57
1679	19,97	58	1736 71 03	251,62	105	1905 80 12	9,20	57
1679 01	12,75	58	1736 71 04	251,62	105	1905 80 13	9,20	57
1679 02	12,75	58	1736 71 06	232,46	105	1905 80 14	9,20	57
1679 03	19,98	58	1736 71 09	228,93	105	1913	1,22	59
1679 04	24,11	58	1736 89 82	228,71	76	1914	1,22	59
1680	14,11	60	1736 89 89	228,71	76	1964 00 01	82,85	193
1686	14,11	60	1736 90 04	251,62	116	1965 02 03	102,65	193
1686 01	14,11	60	1736 90 11	251,62	116	1965 02 08	102,65	193
1687	14,11	60	1738 00 01	285,89	116	1966 02 15	118,03	193
1696 14 04	12,34	73	1738 00 02	275,81	116	1980	17,24	56, 154
1696 16 06	9,31	73	1738 00 69	275,81	116	1984	23,56	56, 154
1696 19 09	8,48	73	1738 14 04	285,23	76	1985	27,34	56, 154
1696 60 72	13,92	92	1738 16 06	279,39	76	1989	46,61	55, 154
1696 60 74	14,03	92	1738 19 09	275,60	76	1990	4,13	55, 154
1696 60 76	14,03	92	1738 60 86	196,03	94	1992	24,48	55, 154
1696 60 79	13,92	92	1738 60 89	275,60	94	1993	41,82	55, 154
1696 60 82	9,69	92	1738 71 03	297,82	105	1994	91,80	55, 154
1696 60 84	16,05	92	1738 71 04	297,82	105	2026 00 01	95,88	116
1696 60 86	16,05	92	1738 71 06	279,39	105	2026 00 02	88,74	116
1696 60 89	9,69	92	1738 71 09	275,81	105	2026 00 09	88,74	116
1696 89 82	8,89	73	1738 89 82	275,60	76	2026 14 04	104,04	76
1696 89 89	8,86	73	1738 89 89	275,60	76	2026 16 06	99,96	76
1705 01 04	27,23	119	1738 90 04	297,82	116	2026 19 09	93,84	76

Referencia	Precio €	Pág. tarifa	Referencia	Precio €	Pág. tarifa	Referencia	Precio €	Pág. tarifa
2026 20 45	77,25	131	2830 10	34,43	62	2953 60 89	76,52	57
2026 20 89	75,00	131	2834 10	298,68	146	2953 70 03	86,88	57
2026 60 82	90,98	94	2834 11	298,68	146	2953 70 04	86,88	57
2026 60 84	101,60	94	2834 20 45	156,64	143	2953 70 06	81,20	57
2026 60 86	101,60	94	2834 20 89	156,64	143	2953 70 09	81,05	57
2026 60 89	90,98	94	2835 10	150,82	146	2953 89 82	76,52	57
2026 71 03	96,90	106	2835 11	150,82	146	2953 89 89	76,52	57
2026 71 04	96,90	106	2835 20 45	79,09	143	2968 01	99,45	63
2026 71 06	92,82	106	2835 20 89	79,09	143	2995	74,00	79
2026 71 09	91,80	106	2844	122,40	63	2996	82,00	79
2026 89 82	82,62	76	2860 10	40,60	62	3031	3,67	54
2026 89 89	82,62	76	2861 10	129,54	62	3032	9,18	54
2026 90 04	104,04	116	2862 10	68,09	62	3032 12	19,99	54
2026 90 11	100,98	116	2866 10	55,42	62	3033 03	15,61	54
2030 00 01	95,88	116	2872	108,50	63	3035	5,51	54
2030 00 02	90,78	116	2873	62,80	62	3035 20	12,65	55
2030 00 69	90,78	116	2875	66,91	62	3035 50	12,34	54
2030 14 04	104,04	76	2880 00 04	306,85	116	3036	4,18	54
2030 16 06	99,96	76	2880 00 69	299,71	116	3036 50	8,16	54
2030 19 09	93,84	76	2880 60 84	300,85	94	3037	8,69	54
2030 20 45	76,15	131	2880 60 89	300,85	94	3038 08	13,67	54
2030 20 89	73,88	131	2880 70 03	306,90	106	33 1532 00 02	129,85	117
2030 60 82	90,98	94	2880 70 04	306,90	106	33 1532 00 69	129,85	117
2030 60 84	100,10	94	2880 70 09	299,63	106	33 1532 14 04	143,79	77
2030 60 86	100,10	94	2880 89 16	307,99	76	33 1532 16 06	139,88	77
2030 60 89	90,98	94	2880 89 89	299,60	76	33 1532 19 09	127,99	77
2030 71 03	96,90	106	2880 99 09	299,98	76	33 1532 20 45	84,49	131
2030 71 04	96,90	106	2882 00 04	61,84	116	33 1532 20 89	83,91	131
2030 71 06	96,90	106	2882 00 69	58,32	116	33 1532 60 82	127,99	95
2030 71 09	91,80	106	2882 60 84	58,78	94	33 1532 60 84	113,04	95
2030 89 82	82,62	76	2882 60 89	58,78	94	33 1532 60 86	113,04	95
2030 89 89	82,62	76	2882 70 03	61,91	106	33 1532 60 89	127,99	95
2030 90 04	104,04	116	2882 70 04	61,91	106	33 1532 70 03	147,70	106
2030 90 11	100,98	116	2882 70 09	58,27	106	33 1532 70 04	147,70	106
2034 00 01	293,45	116	2882 89 16	61,86	76	33 1532 70 06	139,88	106
2034 00 02	288,11	116	2882 89 89	58,27	76	33 1532 70 09	129,85	106
2034 00 69	288,11	116	2882 99 09	58,60	76	33 1532 89 82	127,99	77
2034 14 04	293,86	76	2885	162,59	62	33 1532 89 89	127,99	77
2034 16 06	289,96	76	2891 10	41,82	63	33 1532 90 04	147,70	117
2034 19 09	284,00	76	2896 10	40,70	63	33 1532 90 11	144,98	117
2034 20 45	153,37	131	2897	122,40	63	33 1539 00 02	86,00	117
2034 20 89	151,10	131	2898	173,40	63	33 1539 00 69	86,00	117
2034 60 82	288,11	94	2948	114,79	63	33 1539 14 04	96,90	77
2034 60 84	203,43	94	2948 10	111,29	63	33 1539 16 06	92,95	77
2034 60 86	203,43	94	2951 14 04	110,03	57	33 1539 19 09	84,15	77
2034 60 89	288,11	94	2951 16 06	110,03	57	33 1539 20 45	56,16	131
2034 71 03	301,56	106	2951 19 09	109,17	57	33 1539 20 89	55,56	131
2034 71 04	301,56	106	2951 20 45	115,83	57	33 1539 60 82	84,15	95
2034 71 06	292,46	106	2951 20 89	115,58	57	33 1539 60 84	75,14	95
2034 71 09	288,11	106	2951 60 82	109,46	57	33 1539 60 86	75,14	95
2034 89 82	284,00	76	2951 60 84	111,07	57	33 1539 60 89	84,15	95
2034 89 89	284,00	76	2951 60 86	111,07	57	33 1539 70 03	100,77	106
2034 90 04	301,56	116	2951 60 89	109,46	57	33 1539 70 04	100,77	106
2034 90 11	301,56	116	2951 70 03	110,37	57	33 1539 70 06	92,95	106
2040	105,98	59	2951 70 04	110,37	57	33 1539 70 09	86,00	106
2041	147,70	59	2951 70 06	110,16	57	33 1539 89 82	84,15	77
2411 11 06	3,01	201	2951 70 09	109,17	57	33 1539 89 89	84,15	77
2411 11 09	2,60	201	2951 89 82	109,17	57	33 1539 90 04	100,77	117
2411 11 89	2,60	201	2951 89 89	109,17	57	33 1539 90 11	98,05	117
2411 12 00	76,39	201	2952 14 04	95,55	57	33 1540 00 02	65,89	117
2411 12 06	3,92	201	2952 16 06	89,87	57	33 1540 00 69	65,89	117
2411 12 09	3,49	201	2952 19 09	85,19	57	33 1540 14 04	75,39	77
2411 12 89	3,49	201	2952 20 45	89,87	57	33 1540 16 06	71,48	77
2412 11 06	5,22	201	2952 20 89	89,72	57	33 1540 19 09	64,08	77
2412 11 09	4,90	201	2952 60 82	85,19	57	33 1540 20 45	67,57	131
2412 11 89	4,90	201	2952 60 84	89,87	57	33 1540 20 89	57,92	131
2412 12 06	7,03	201	2952 60 86	89,87	57	33 1540 60 82	64,08	95
2412 12 09	6,77	201	2952 60 89	85,19	57	33 1540 60 84	90,58	95
2412 12 89	6,77	201	2952 70 03	95,55	57	33 1540 60 86	90,58	95
2412 13 06	6,16	201	2952 70 04	95,55	57	33 1540 60 89	64,08	95
2412 13 09	5,84	201	2952 70 06	89,87	57	33 1540 70 03	79,29	106
2412 13 89	5,84	201	2952 70 09	89,72	57	33 1540 70 04	79,29	106
2600 05	96,07	55	2952 89 82	85,19	57	33 1540 70 06	71,48	106
2600 09	96,07	55	2952 89 89	85,19	57	33 1540 70 09	65,89	106
2600 20 45	57,47	143	2953 14 04	86,88	57	33 1540 89 82	64,08	77
2600 20 89	57,47	143	2953 16 06	81,20	57	33 1540 89 89	64,08	77
2819 01	25,50	62	2953 19 09	76,52	57	33 1540 90 04	79,29	117
2819 89 82	25,39	70	2953 20 45	81,20	57	33 1540 90 11	76,54	117
2819 89 89	25,50	70	2953 20 89	81,05	57	33 1541 00 02	65,89	117
2819 99 09	25,58	70	2953 60 82	76,52	57	33 1541 00 69	65,89	117
2819 99 39	50,42	70	2953 60 84	81,20	57	33 1541 14 04	75,39	77
2819 99 49	46,72	70	2953 60 86	81,20	57	33 1541 16 06	71,48	77

Tabla de correspondencia

Referencia - Precio - Página tarifa



Referencia	Precio €	Pág. tarifa	Referencia	Precio €	Pág. tarifa	Referencia	Precio €	Pág. tarifa
33 1541 19 09	64,08	77	3877 00	29,99	146	4738 70 04	16,12	103
33 1541 20 45	63,09	131	3893 00	77,93	146	4738 70 06	13,87	103
33 1541 20 89	64,11	131	3956 19	19,18	54	4738 70 09	13,35	103
33 1541 60 82	64,08	95	3966	14,18	54	4755	26,83	146
33 1541 60 84	93,35	95	4109 00 02	74,01	113	4755 01	26,83	146
33 1541 60 86	93,35	95	4109 00 69	73,97	113	4755 20 45	16,11	142
33 1541 60 89	64,08	95	4109 14 04	76,12	73	4755 20 89	16,11	142
33 1541 70 03	79,29	106	4109 16 06	74,37	73	5031	4,50	54
33 1541 70 04	79,29	106	4109 19 09	74,29	73	5031 01	8,36	54
33 1541 70 06	71,48	106	4109 20 45	85,53	129, 142	5031 50	9,28	54
33 1541 70 09	65,89	106	4109 20 89	85,53	129, 142	5032 03	14,24	54
33 1541 89 82	64,08	77	4109 60 82	76,41	91	5034 04	15,81	55
33 1541 89 89	64,08	77	4109 60 84	76,41	91	5035	8,36	54
33 1541 90 04	79,29	117	4109 60 86	76,41	91	5035 01	12,23	54
33 1541 90 11	76,54	117	4109 60 89	76,41	91	5035 03	12,75	54
33 1542 00 02	148,10	117	4109 70 03	77,39	103	5035 20	12,04	55
33 1542 00 69	148,10	117	4109 70 04	76,25	103	5036	6,53	54
33 1542 14 04	163,32	77	4109 70 06	76,04	103	5038 08	23,26	54
33 1542 16 06	159,42	77	4109 70 09	73,97	103	5038 08 01	11,05	54
33 1542 19 09	146,30	77	4109 89 82	74,37	73	5038 08 02	11,05	54
33 1542 20 45	96,30	131	4109 89 89	74,29	73	5051 02	8,87	54
33 1542 20 89	95,72	131	4109 90 04	77,35	113	5051 03	13,26	54
33 1542 60 82	146,30	95	4109 90 11	81,66	113	5052 01	21,52	54
33 1542 60 84	128,85	95	4110 00 02	22,53	113	5056 01	8,87	54
33 1542 60 86	128,85	95	4110 00 69	22,53	113	5101	6,22	58
33 1542 60 89	146,30	95	4110 19 09	20,93	73	5101 10	10,20	58
33 1542 70 03	167,23	106	4110 20 45	75,73	129	5101 89 82	25,50	75
33 1542 70 04	167,23	106	4110 20 89	75,73	129	5101 89 89	25,50	75
33 1542 70 06	159,42	106	4110 60 82	65,78	91	5101 99 09	25,50	75
33 1542 70 09	148,10	106	4110 60 84	65,78	91	5104	21,52	146
33 1542 89 82	146,30	77	4110 60 86	65,78	91	5104 01	21,52	146
33 1542 89 89	146,30	77	4110 60 89	65,78	91	5131 02	10,91	58
33 1542 90 04	167,23	117	4110 70 09	37,71	103	63 3023	22,13	54
33 1542 90 11	164,52	117	4110 89 82	20,93	73	67 1009 14 04	14,20	75
33 1543 00 02	148,10	117	4110 89 89	20,93	73	67 1009 16 06	11,10	75
33 1543 00 69	148,10	117	4135 00 07	29,77	121	67 1009 19 09	8,57	75
33 1543 14 04	163,32	77	4142 89 82	5,80	73	67 1009 20	27,85	147
33 1543 16 06	159,42	77	4142 89 89	5,80	73	67 1009 21	27,85	147
33 1543 19 09	146,30	77	4142 99 09	5,80	73	67 1009 60 82	9,89	93
33 1543 20 45	96,30	131	4149 14 04	15,91	73	67 1009 60 84	11,75	93
33 1543 20 89	95,72	131	4149 16 06	12,44	73	67 1009 60 86	11,75	93
33 1543 60 82	146,30	95	4149 19 09	11,22	73	67 1009 60 89	9,89	93
33 1543 60 84	128,85	95	4149 60 82	10,61	91	67 1009 89 82	8,47	75
33 1543 60 86	128,85	95	4149 60 84	10,61	91	67 1009 89 89	8,47	75
33 1543 60 89	146,30	95	4149 60 86	10,61	91	67 1044 00 01	14,99	115
33 1543 70 03	167,23	106	4149 60 89	10,61	91	67 1044 00 04	17,65	115
33 1543 70 04	167,23	106	4149 89 82	10,40	73	67 1045 00 01	12,65	115
33 1543 70 06	159,42	106	4149 89 89	10,40	73	67 1045 00 02	10,10	115
33 1543 70 09	148,10	106	4468	8,26	59	67 1045 00 69	10,10	115
33 1543 89 82	146,30	77	4470	10,00	59	67 1045 70 03	14,67	105
33 1543 89 89	146,30	77	4502 10	15,30	55	67 1045 70 04	14,67	105
33 1543 90 04	167,23	117	4505	11,03	56	67 1045 70 06	11,55	105
33 1543 90 11	164,52	117	4505 01	11,73	55	67 1045 70 09	10,30	105
33 4475 86 06	90,78	73	4505 02	44,57	55	67 3039 09	23,46	54
33 4475 89 09	89,00	73	4508 20	32,64	147	67 6874 00 07	29,77	121
33 4476 70 09	91,00	103	4508 21	32,64	147	67 6879	12,95	146
33 4476 70 16	92,82	103	4522 10	15,30	55	67 6879 01	12,95	146
3811	31,82	146	4538	8,67	56	68 1033 14 04	5,60	78
3811 01	31,82	146	4540 01	6,22	56	68 1033 16 06	5,60	78
3811 20 45	64,68	143	4540 02	8,98	56	68 1033 19 09	3,80	78
3811 20 89	62,56	143	4540 04	6,22	56	68 1033 20 45	6,85	130
3812	36,82	146	4541 01	6,22	56	68 1033 20 89	4,25	130
3812 01	36,82	146	4541 04	6,22	56	68 1033 60 82	4,05	96
3812 20 45	72,13	143	4541 05	8,98	56	68 1033 60 84	6,02	96
3812 20 89	70,01	143	4541 07	8,98	56	68 1033 60 86	6,02	96
3822 10	84,05	55	4541 09	8,02	56	68 1033 60 89	4,05	96
3826 10	112,40	54	4554 01	21,00	56	68 1033 89 82	3,60	78
3831 10	78,03	55	4555 01	27,00	56	68 1033 89 89	3,60	78
3832 10	84,05	55	4562	18,05	56	68 1034 00 01	10,00	119
3838 00	24,68	146	4572 05	19,69	55	68 1034 00 04	10,00	119
3841	21,93	55	4572 09	19,69	55	68 1034 70 03	10,00	108
3842	31,01	55	4573 05	21,42	55	68 1034 70 04	10,00	108
3846 00	19,89	146	4573 09	21,42	55	68 1034 70 06	6,80	108
3851	24,17	55	4582	416,67	56	68 1034 70 09	4,20	108
3852	32,03	55	4583	500,91	56	68 1035 00 01	4,20	119
3856 20	97,82	54	4588	38,33	56	68 1035 00 02	4,20	119
3861	25,50	54	4593	36,65	55	68 1035 00 69	4,20	119
3861 01	43,15	54	4594 10	20,00	55	7141 34	4,24	55
3862	77,52	54	4604	30,09	59	7504 00 01	91,80	201
3862 01	87,52	54	4605	24,07	59	7504 00 03	91,80	201
3875 00	18,77	146	4637	3,22	154	7504 10 04	157,98	197
3876 00	15,30	146	4738 70 03	16,12	103	7504 20 04	168,50	197

Referencia	Precio €	Pág. tarifa	Referencia	Precio €	Pág. tarifa	Referencia	Precio €	Pág. tarifa
7514 10 34	215,40	194	7516 30 93	111,14	200	7566 36 92	364,23	201
7514 11 34	424,21	194	7516 30 94	118,99	200	7566 36 93	306,59	201
7514 11 50	238,72	197	7516 30 99	71,69	200	7566 36 94	316,56	201
7514 11 55	238,72	197	7516 35 90	190,50	200	7566 36 99	267,17	201
7514 11 60	268,72	197	7516 35 92	190,50	200	7566 45 90	435,30	200
7514 11 65	268,72	197	7516 35 93	138,34	200	7566 45 92	435,30	200
7514 18 30	229,86	194	7516 35 94	142,84	200	7566 45 93	367,69	200
7514 18 35	233,31	194	7516 35 99	98,87	200	7566 45 94	379,64	200
7514 18 50	233,04	197	7516 40 90	203,81	200	7566 45 99	307,46	200
7514 18 55	233,04	197	7516 40 92	203,81	200	7566 46 90	463,02	201
7514 18 60	265,49	197	7516 40 93	190,20	200	7566 46 92	463,02	201
7514 18 65	265,49	197	7516 40 94	164,31	200	7566 46 93	394,56	201
7514 19 30	424,21	194	7516 40 99	83,26	200	7566 46 94	407,38	201
7514 19 35	424,21	194	7516 45 90	235,22	200	7566 46 99	334,32	201
7514 20 34	259,74	194	7516 45 92	235,22	200	7566 55 90	506,81	200
7514 21 34	430,21	194	7516 45 93	173,95	200	7566 55 92	506,81	200
7514 21 50	272,02	197	7516 45 94	179,60	200	7566 55 93	416,68	200
7514 21 55	272,02	197	7516 45 99	113,69	200	7566 55 94	430,23	200
7514 21 60	272,02	197	7516 86 90	258,53	200	7566 55 99	348,20	200
7514 21 65	272,02	197	7516 86 92	258,53	200	7566 56 90	534,53	201
7514 28 30	240,65	194	7516 86 93	196,50	200	7566 56 92	534,53	201
7514 28 35	340,60	194	7516 86 94	202,89	200	7566 56 93	443,55	201
7514 28 50	270,03	197	7516 86 99	136,26	200	7566 56 94	457,96	201
7514 28 55	270,03	197	7544 12 26	226,36	195	7566 56 99	375,05	201
7514 28 60	270,03	197	7544 12 29	226,36	195	7574 01 01	748,85	203
7514 28 65	270,03	197	7544 12 52	225,56	195	7590 00 31	40,33	194
7514 29 30	430,21	194	7544 12 59	226,36	195	7590 00 80	8,95	201
7514 29 35	430,21	194	7544 12 71	235,16	195	7590 00 81	12,93	201
7514 30 34	280,01	194	7544 12 73	230,78	195	7590 00 82	17,00	201
7514 31 34	440,00	194	7544 12 75	227,16	195	7594 02 29	7,89	195
7514 31 50	311,40	197	7544 12 79	226,36	195	7594 02 52	6,62	195
7514 31 55	311,40	197	7544 12 83	230,04	195	7594 02 59	7,89	195
7514 31 60	311,40	197	7544 12 85	227,16	195	7594 02 73	10,63	195
7514 31 65	311,40	197	7544 12 89	226,36	195	7594 02 75	8,22	195
7514 38 30	280,01	194	7544 13 22	297,00	196	7594 02 79	7,89	195
7514 38 35	302,04	194	7544 13 24	300,24	196	7594 02 83	10,11	195
7514 38 50	280,01	197	7544 13 26	300,24	196	7594 02 85	8,22	195
7514 38 55	280,01	197	7544 13 29	297,00	196	7594 02 89	7,89	195
7514 38 60	280,01	197	7544 13 52	297,00	196	7594 04 02	3,59	76, 106, 116
7514 38 65	280,01	197	7544 13 59	297,00	196	7594 04 03	13,90	76, 106, 116
7514 39 30	440,00	194	7544 13 71	324,00	196	7594 04 04	13,90	76, 106, 116
7514 39 35	440,00	194	7544 13 73	324,00	196	7594 04 09	3,59	76, 106, 116
7514 40 34	324,74	194	7544 13 75	300,24	196	7594 04 83	11,10	76, 106, 116
7514 41 34	450,21	194	7544 13 79	297,00	196	7594 04 85	9,22	76, 94, 106, 116
7514 41 50	356,12	197	7544 13 81	324,00	196	7594 04 89	3,59	76, 94, 106, 116
7514 41 55	356,12	197	7544 13 83	300,24	196	7594 10 01	8,68	63
7514 41 60	356,12	197	7544 13 85	300,24	196	8 1836	1,83	156
7514 41 65	356,12	197	7544 13 89	297,00	196	8 1836 01	1,83	156
7514 48 30	324,74	194	7564 20 30	389,95	194	8 1836 02	1,47	156
7514 48 35	324,74	194	7564 20 34	500,36	194	8 1837	2,00	156
7514 48 50	324,74	197	7564 20 35	500,36	194	8 4516 25 68	10,15	152
7514 48 55	324,74	197	7564 20 50	389,95	197	8 4558 25 05	5,60	154
7514 48 60	324,74	197	7564 20 55	389,95	197	8 4558 25 07	5,60	154
7514 48 65	324,74	197	7564 20 60	389,95	197	8 4558 25 09	5,60	154
7514 49 30	450,21	194	7564 20 65	389,95	197	8 4558 25 10	5,60	154
7514 49 35	450,21	194	7564 21 30	566,19	194	8 4563 25 03	15,61	154
7516 10 90	88,72	200	7564 21 34	566,19	194	8 4563 25 06	15,61	154
7516 10 92	88,72	200	7564 21 35	566,19	194	8 4571 25 01	9,71	154
7516 10 93	71,74	200	7564 21 50	421,33	197	8 4571 25 03	9,71	154
7516 10 94	74,38	200	7564 21 55	421,33	197	8 4571 25 05	9,71	154
7516 10 99	45,84	200	7564 21 60	421,33	197	8 4571 25 07	9,71	154
7516 15 90	117,82	200	7564 21 65	421,33	197	8 4571 25 09	9,71	154
7516 15 92	117,82	200	7564 30 30	421,55	194	8 6254 25 01	70,29	153
7516 15 93	99,91	200	7564 30 34	544,25	194	8 6254 25 05	70,29	153
7516 15 94	103,15	200	7564 30 35	544,25	194	8 6254 25 07	70,29	153
7516 15 99	74,01	200	7564 30 50	421,55	197	8 6254 25 09	70,29	153
7516 18 65	9,46	197	7564 30 55	421,55	197	8 6254 25 10	70,29	153
7516 18 69	10,04	197	7564 30 60	421,55	197	8 6263 25 01	18,42	153
7516 20 90	121,33	200	7564 30 65	421,55	197	8 6263 25 02	18,42	153
7516 20 92	121,33	200	7564 31 30	610,08	194	8 6263 25 13	18,42	153
7516 20 93	94,75	200	7564 31 34	610,08	194	8004 00 01	91,80	209
7516 20 94	109,27	200	7564 31 35	610,08	194	8004 00 11	918,00	209
7516 20 99	55,82	200	7564 31 50	452,93	197	8014 11 70	72,29	207
7516 25 90	151,12	200	7564 31 55	452,93	197	8014 11 80	72,29	207
7516 25 92	151,12	200	7564 31 60	452,93	197	8014 13 26	59,42	209
7516 25 93	123,64	200	7564 31 65	452,93	197	8014 13 29	58,09	209
7516 25 94	127,66	200	7566 35 90	332,03	200	8014 21 70	85,51	207
7516 25 99	84,70	200	7566 35 92	332,03	200	8014 21 80	85,51	207
7516 28 65	13,02	197	7566 35 93	279,78	200	8014 23 26	70,72	209
7516 28 69	11,59	197	7566 35 94	288,86	200	8014 23 29	69,33	209
7516 30 90	162,40	200	7566 35 99	240,31	200	8014 33 26	88,76	209
7516 30 92	162,40	200	7566 36 90	364,23	201	8014 33 29	90,54	209

Tabla de correspondencia

Referencia - Precio - Página tarifa



Referencia	Precio €	Pág. tarifa	Referencia	Precio €	Pág. tarifa	Referencia	Precio €	Pág. tarifa
8014 43 26	101,95	209	8096 04 83	10,77	209	8514 21 79	25,44	179
8014 43 29	100,25	209	8096 04 85	8,95	209	8514 21 82	18,99	179
8016 17 70	58,09	209	8096 12 21	11,67	207	8514 21 83	24,87	179
8016 17 73	61,10	209	8096 12 22	9,07	207	8514 21 85	20,13	179
8016 17 74	59,42	209	8096 12 26	11,67	207	8514 21 88	18,99	179
8016 17 76	59,42	209	8096 12 29	9,07	207	8514 21 89	18,99	179
8016 17 80	58,09	209	8096 12 71	16,88	207	8514 51 22	113,64	181
8016 17 85	59,42	209	8096 12 73	16,88	207	8514 51 24	117,47	181
8016 18 65	58,09	209	8096 12 75	11,47	207	8514 51 26	117,47	181
8016 18 69	59,42	209	8096 12 79	10,06	207	8514 51 29	113,64	181
8016 27 70	69,33	209	8096 12 82	9,86	207	8514 51 31	114,50	181
8016 27 73	72,80	209	8096 12 83	11,28	207	8514 51 39	114,50	181
8016 27 74	70,72	209	8096 12 85	10,06	207	8514 51 73	121,75	181
8016 27 76	70,72	209	8096 12 89	9,86	207	8514 51 75	118,33	181
8016 27 80	69,33	209	8096 12 99	9,66	207	8514 51 77	121,75	181
8016 27 85	70,72	209	8096 13 21	28,55	207	8514 51 79	114,50	181
8016 28 65	70,72	209	8096 13 22	17,70	207	8514 51 82	113,64	181
8016 28 69	69,33	209	8096 13 26	20,51	207	8514 51 83	120,89	181
8016 37 70	88,76	209	8096 13 29	17,70	207	8514 51 85	117,47	181
8016 37 73	93,42	209	8096 13 71	35,21	207	8514 51 88	113,64	181
8016 37 74	90,54	209	8096 13 73	35,21	207	8514 51 89	113,64	181
8016 37 76	90,54	209	8096 13 75	20,90	207	8514 61 22	139,21	181
8016 37 80	88,76	209	8096 13 79	18,69	207	8514 61 24	143,04	181
8016 37 85	90,54	209	8096 13 82	17,70	207	8514 61 26	143,04	181
8016 47 70	100,25	209	8096 13 83	20,11	207	8514 61 29	139,21	181
8016 47 73	103,40	209	8096 13 85	18,50	207	8514 61 31	139,95	181
8016 47 74	101,95	209	8096 13 89	17,70	207	8514 61 39	139,95	181
8016 47 76	101,95	209	8096 13 99	18,50	207	8514 61 73	147,20	181
8016 47 80	100,25	209	8096 22 21	11,67	207	8514 61 75	143,78	181
8016 47 85	101,95	209	8096 22 22	9,07	207	8514 61 77	147,20	181
8026 21 60	170,21	209	8096 22 26	11,67	207	8514 61 79	139,95	181
8026 21 70	170,21	209	8096 22 29	9,07	207	8514 61 82	139,21	181
8026 21 80	170,21	209	8096 22 71	16,88	207	8514 61 83	146,45	181
8026 22 60	170,21	209	8096 22 73	16,88	207	8514 61 85	143,04	181
8026 22 70	170,21	209	8096 22 75	11,47	207	8514 61 88	139,21	181
8026 22 80	170,21	209	8096 22 79	10,06	207	8514 61 89	139,21	181
8044 01 00	230,00	205	8096 22 82	10,25	207	8522 11 00	56,97	178
8066 01 00	295,00	205	8096 22 83	11,67	207	8524 11 22	72,97	180
8096 01 26	10,10	205	8096 22 85	10,25	207	8524 11 24	76,80	180
8096 01 29	9,50	205	8096 22 89	10,25	207	8524 11 26	76,80	180
8096 01 71	20,00	205	8096 22 99	10,25	207	8524 11 29	72,97	180
8096 01 75	12,50	205	8096 23 21	30,76	207	8524 11 31	73,80	180
8096 01 79	12,50	205	8096 23 22	17,70	207	8524 11 39	73,80	180
8096 01 80	9,50	205	8096 23 26	17,70	207	8524 11 73	81,04	180
8096 01 82	9,20	205	8096 23 29	17,70	207	8524 11 75	77,63	180
8096 01 83	10,50	205	8096 23 71	16,09	207	8524 11 77	81,04	180
8096 01 85	10,10	205	8096 23 73	29,37	207	8524 11 79	73,80	180
8096 01 89	9,20	205	8096 23 75	15,69	207	8524 11 82	72,97	180
8096 02 21	3,62	207	8096 23 79	13,48	207	8524 11 83	80,21	180
8096 02 22	3,23	207	8096 23 82	12,46	207	8524 11 85	76,80	180
8096 02 26	3,62	207	8096 23 83	15,10	207	8524 11 88	72,97	180
8096 02 29	3,23	207	8096 23 85	13,09	207	8524 11 89	72,97	180
8096 02 71	9,28	207	8096 23 89	12,46	207	8524 52 22	126,27	182
8096 02 73	9,28	207	8096 23 99	12,46	207	8524 52 24	130,10	182
8096 02 75	5,58	207	8502 01 00	26,59	178	8524 52 26	130,10	182
8096 02 79	5,50	207	8512 11 00	53,17	178	8524 52 29	126,27	182
8096 02 82	3,23	207	8512 12 00	64,56	178	8524 52 31	127,33	182
8096 02 83	5,50	207	8512 22 00	104,44	178	8524 52 39	127,33	182
8096 02 85	3,62	207	8514 11 22	15,00	179	8524 52 73	134,48	182
8096 02 89	3,23	207	8514 11 24	16,10	179	8524 52 75	131,06	182
8096 02 99	3,23	207	8514 11 26	16,10	179	8524 52 77	134,48	182
8096 03 26	6,49	207	8514 11 29	15,00	179	8524 52 79	127,23	182
8096 03 29	6,25	207	8514 11 31	21,00	179	8524 52 82	126,27	182
8096 03 71	13,54	207	8514 11 39	19,00	179	8524 52 83	133,52	182
8096 03 73	13,54	207	8514 11 73	23,04	179	8524 52 85	130,10	182
8096 03 75	8,34	207	8514 11 75	18,17	179	8524 52 88	126,27	182
8096 03 79	8,29	207	8514 11 77	23,04	179	8524 52 89	126,27	182
8096 03 82	6,25	207	8514 11 79	17,81	179	8532 01 00	40,00	178
8096 03 83	8,38	207	8514 11 82	13,3	179	8534 11 22	68,00	180
8096 03 85	6,49	207	8514 11 83	17,42	179	8534 11 24	71,83	180
8096 03 89	6,25	207	8514 11 85	14,10	179	8534 11 26	71,83	180
8096 03 99	6,25	207	8514 11 88	13,60	179	8534 11 29	68,00	180
8096 04 26	8,95	209	8514 11 89	13,30	179	8534 11 31	68,70	180
8096 04 29	6,84	209	8514 21 22	18,99	179	8534 11 39	68,70	180
8096 04 52	6,84	209	8514 21 24	20,13	179	8534 11 73	75,95	180
8096 04 59	6,84	209	8514 21 26	20,13	179	8534 11 75	72,53	180
8096 04 60	10,96	209	8514 21 29	18,99	179	8534 11 77	75,95	180
8096 04 65	11,25	209	8514 21 31	27,13	179	8534 11 79	68,70	180
8096 04 71	13,37	209	8514 21 39	29,99	179	8534 11 82	68,00	180
8096 04 73	13,37	209	8514 21 73	30,67	179	8534 11 83	75,24	180
8096 04 75	11,25	209	8514 21 75	25,80	179	8534 11 85	71,83	180
8096 04 79	10,96	209	8514 21 77	30,67	179	8534 11 88	68,00	180

Referencia	Precio €	Pág. tarifa	Referencia	Precio €	Pág. tarifa	Referencia	Precio €	Pág. tarifa
8534 11 89	68,00	180	8564 81 26	168,29	181	8574 51 82	164,46	182
8534 12 22	111,26	179	8564 81 29	164,46	181	8574 51 83	171,71	182
8534 12 24	115,09	179	8564 81 31	165,39	181	8574 51 85	168,29	182
8534 12 26	115,09	179	8564 81 39	165,39	181	8574 51 88	164,46	182
8534 12 29	111,26	179	8564 81 73	172,64	181	8574 51 89	164,46	182
8534 12 31	111,96	179	8564 81 75	169,22	181	8574 52 22	164,46	181
8534 12 39	111,96	179	8564 81 77	172,64	181	8574 52 24	168,29	181
8534 12 73	119,20	179	8564 81 79	165,39	181	8574 52 26	168,29	181
8534 12 75	115,79	179	8564 81 82	164,46	181	8574 52 29	164,46	181
8534 12 77	119,20	179	8564 81 83	171,71	181	8574 52 31	165,39	181
8534 12 79	111,96	179	8564 81 85	168,29	181	8574 52 39	165,39	181
8534 12 82	111,26	179	8564 81 88	164,46	181	8574 52 73	172,64	181
8534 12 83	118,51	179	8564 81 89	164,46	181	8574 52 75	169,22	181
8534 12 85	115,09	179	8565 51 31	118,01	183	8574 52 77	172,64	181
8534 12 88	111,26	179	8565 51 39	118,01	183	8574 52 79	165,39	181
8534 12 89	111,26	179	8565 51 82	117,20	183	8574 52 82	164,46	181
8534 21 22	68,00	180	8565 51 83	124,20	183	8574 52 83	171,71	181
8534 21 24	71,83	180	8565 51 85	120,90	183	8574 52 85	168,29	181
8534 21 26	71,83	180	8565 51 88	117,20	183	8574 52 88	164,46	181
8534 21 29	68,00	180	8565 51 89	117,20	183	8574 52 89	164,46	181
8534 21 31	68,70	180	8565 52 22	117,20	183	9 1151 25 01	6,83	156
8534 21 39	68,70	180	8565 52 24	124,20	183	9 1151 25 05	6,83	156
8534 21 73	75,95	180	8565 52 26	124,20	183	9 1151 25 07	10,67	156
8534 21 75	72,53	180	8565 52 29	117,20	183	9 1151 25 09	6,83	156
8534 21 77	75,95	180	8565 52 31	118,01	183	9 1151 25 10	10,47	156
8534 21 79	68,70	180	8565 52 39	118,01	183	9 1151 25 11	7,99	156
8534 21 82	68,00	180	8565 52 73	125,01	183	9 1151 25 15	7,99	156
8534 21 83	75,24	180	8565 52 75	121,71	183	9 1151 25 17	7,99	156
8534 21 85	71,83	180	8565 52 77	125,01	183	9 1151 25 19	7,99	156
8534 21 88	68,00	180	8565 52 79	118,01	183	9 1151 25 20	10,43	156
8534 21 89	68,00	180	8565 52 82	117,20	183	9 1152 25 25	2,94	156
8534 22 22	111,26	179	8565 52 83	120,90	183	9 1152 25 29	4,72	156
8534 22 24	115,09	179	8565 52 85	124,20	183	9 1152 25 55	8,31	156
8534 22 26	115,09	179	8565 52 88	117,20	183	9 1152 25 59	8,39	156
8534 22 29	111,26	179	8565 52 89	117,20	183	9 1152 25 65	4,10	156
8534 22 31	111,96	179	8565 61 31	142,60	183	9 1152 25 69	10,75	156
8534 22 39	111,96	179	8565 61 39	142,60	183	9 1803 25 05	5,21	152
8534 22 73	119,20	179	8565 61 82	141,70	183	9 1803 25 07	5,21	152
8534 22 75	115,79	179	8565 61 83	148,70	183	9 1803 25 09	5,21	152
8534 22 77	119,20	179	8565 61 85	145,40	183	9 1803 25 68	18,20	152
8534 22 79	111,96	179	8565 61 88	141,70	183	9 1819 25 07	3,38	152
8534 22 82	111,26	179	8565 61 89	141,70	183	9 1819 25 10	3,38	152
8534 22 83	118,51	179	8565 62 22	141,80	183	9 1819 25 11	3,38	152
8534 22 85	115,09	179	8565 62 24	145,50	183	9 1819 25 15	3,38	152
8534 22 88	111,26	179	8565 62 26	145,50	183	9 1819 25 19	3,38	152
8534 22 89	111,26	179	8565 62 29	141,80	183	9 1819 25 24	18,10	152
8534 51 22	139,21	182	8565 62 31	142,60	183	9 1819 25 68	18,10	152
8534 51 24	143,04	182	8565 62 39	142,60	183	9 1820	1,79	156
8534 51 26	143,04	182	8565 62 73	149,60	183	9 1820 01	1,68	156
8534 51 29	139,21	182	8565 62 75	146,30	183	9 1825 25 06	2,28	156
8534 51 31	139,95	182	8565 62 77	149,60	183	9 1825 25 10	2,28	156
8534 51 39	139,95	182	8565 62 79	142,60	183	9 1825 25 11	2,28	156
8534 51 73	147,20	182	8565 62 82	141,80	183	9 1825 25 12	2,28	156
8534 51 75	143,78	182	8565 62 83	148,80	183	9 1825 25 15	2,28	156
8534 51 77	147,20	182	8565 62 85	145,50	183	9 1825 25 24	8,87	156
8534 51 79	139,95	182	8565 62 88	141,80	183	9 1825 25 68	8,87	156
8534 51 82	139,21	182	8565 62 89	141,80	183	9 1826 25 07	2,28	152
8534 51 83	146,45	182	8574 11 22	139,21	180	9 1826 25 10	2,28	152
8534 51 85	143,04	182	8574 11 24	143,04	180	9 1826 25 11	2,28	152
8534 51 88	139,21	182	8574 11 26	143,04	180	9 1826 25 15	2,28	152
8534 51 89	139,21	182	8574 11 29	139,21	180	9 1826 25 19	2,28	152
8534 61 22	139,21	182	8574 11 31	139,95	180	9 1826 25 24	13,57	152
8534 61 24	143,04	182	8574 11 39	139,95	180	9 1826 25 58	13,57	152
8534 61 26	143,04	182	8574 11 73	147,20	180	9 1827 25 01	0,95	152
8534 61 29	139,21	182	8574 11 75	143,78	180	9 1827 25 05	0,95	152
8534 61 31	139,95	182	8574 11 77	147,20	180	9 1827 25 07	0,95	152
8534 61 39	139,95	182	8574 11 79	139,95	180	9 1827 25 09	0,95	152
8534 61 73	147,20	182	8574 11 82	139,21	180	9 1827 25 10	0,95	152
8534 61 75	143,78	182	8574 11 83	146,45	180	9 1827 25 24	10,65	152
8534 61 77	147,20	182	8574 11 85	143,04	180	9 1827 25 58	10,65	152
8534 61 79	139,95	182	8574 11 88	139,21	180	9 1827 25 68	12,65	152
8534 61 82	139,21	182	8574 11 89	139,21	180	9 1827 25 91	1,05	152
8534 61 83	146,45	182	8574 11 22	164,46	182	9 1827 25 95	1,05	152
8534 61 85	143,04	182	8574 51 24	168,29	182	9 1827 25 97	1,05	152
8534 61 88	139,21	182	8574 51 26	168,29	182	9 1827 25 99	1,05	152
8534 61 89	139,21	182	8574 51 29	164,46	182	9 1828 25 01	3,37	152
8542 11 00	70,27	178	8574 51 31	165,39	182	9 1828 25 05	3,37	152
8542 12 00	87,46	178	8574 51 39	165,39	182	9 1828 25 07	3,37	152
8542 17 00	110,00	178	8574 51 73	172,64	182	9 1828 25 09	3,37	152
8542 21 00	128,30	178	8574 51 75	169,22	182	9 1828 25 10	3,37	152
8564 81 22	164,46	181	8574 51 77	172,64	182	9 1828 25 24	14,93	152
8564 81 24	168,29	181	8574 51 79	165,39	182	9 1828 25 68	15,47	152

Referencia	Precio €	Pág. tarifa	Referencia	Precio €	Pág. tarifa	Referencia	Precio €	Pág. tarifa
9 1828 25 76	4,12	152	9 3752 25 01	15,34	155	9 6249 25 02	18,42	153
9 1828 25 78	14,93	152	9 3752 25 05	15,34	155	9 6249 25 05	18,42	153
9 1828 25 91	4,42	152	9 3752 25 07	15,34	155	9 6249 25 06	18,42	153
9 1828 25 95	4,42	152	9 3752 25 09	15,34	155	9 6256 05	41,27	153
9 1828 25 97	4,42	152	9 3752 25 10	15,34	155	9 6256 25 01	41,27	153
9 1828 25 99	4,42	152	9 3752 25 24	18,98	155	9 6256 25 02	41,27	153
9 1844	1,47	156	9 3752 25 68	18,98	155	9 6256 25 05	41,27	153
9 1853	1,47	156	9 3762 25 10	33,19	155	9 6256 25 06	41,27	153
9 1883	2,00	156	9 3762 25 24	39,41	155	9 6257 25 01	12,51	153
9 1887	2,10	156	9 3762 25 31	33,19	155	9 6257 25 02	12,51	153
9 1915 01	6,39	156	9 3762 25 35	33,19	155	9 6257 25 03	12,51	153
9 1915 02	2,94	156	9 3762 25 39	33,19	155	9 6257 25 05	12,51	153
9 1933	4,20	156	9 3762 25 68	39,41	155	9 6257 25 06	12,51	153
9 1988 25 02	10,82	152	9 3772 25 01	17,54	155	9 6259 25 01	18,42	153
9 1988 25 05	10,82	152	9 3772 25 05	17,54	155	9 6259 25 02	18,42	153
9 1988 25 06	10,82	152	9 3772 25 07	17,54	155	9 6259 25 03	18,42	153
9 2600 25 05	49,76	154	9 3772 25 09	17,54	155	9 6259 25 05	18,42	153
9 2600 25 09	49,76	154	9 4195 05	7,46	153	9 6259 25 06	18,42	153
9 2871 25 71	85,63	155	9 4195 25 01	7,46	153	9 6262 05	12,11	153
9 2871 25 75	85,63	155	9 4195 25 02	7,46	153	9 6262 25 01	12,11	153
9 2871 25 77	85,63	155	9 4195 25 05	7,46	153	9 6262 25 02	12,11	153
9 2871 25 79	85,63	155	9 4195 25 06	7,46	153	9 6262 25 05	12,11	153
9 2876 25 01	77,96	155	9 4511 15	5,04	154	9 6262 25 06	12,11	153
9 2876 25 05	77,96	155	9 4511 25 11	5,04	154	9 6272 05	13,08	153
9 2876 25 07	77,96	155	9 4511 25 12	5,04	154	9 6272 25 02	13,08	153
9 2876 25 09	77,96	155	9 4511 25 15	5,04	154	9 6272 25 05	13,08	153
9 2876 25 10	77,96	155	9 4511 25 16	5,04	154	9 6272 25 06	13,08	153
9 2876 25 24	102,01	155	9 4516 25 01	2,51	152	9498 29 01	33,16	195
9 2876 25 68	102,01	155	9 4516 25 05	2,51	152	9498 30 02	36,10	195
9 2891 25 01	74,81	155	9 4516 25 07	2,51	152	9498 31 03	36,05	195
9 2891 25 05	74,81	155	9 4516 25 09	2,51	152	9498 32 04	35,92	195
9 2891 25 06	74,81	155	9 4516 25 10	2,51	152			
9 2891 25 09	74,81	155	9 4516 25 24	10,15	152	B		
9 3652 25 01	11,77	155	9 4517 05	13,56	154	BBH01	33,90	59
9 3652 25 05	11,77	155	9 4517 25 01	13,56	154			
9 3652 25 07	11,77	155	9 4517 25 05	13,56	154	E		
9 3652 25 09	11,77	155	9 4517 25 07	13,56	154	EE807	51,98	241
9 3652 25 10	11,77	155	9 4517 25 09	13,56	154	EE808	41,80	241
9 3652 25 24	23,84	155	9 4519 05	7,04	154	EE813	consultar	241
9 3652 25 68	23,84	155	9 4519 25 01	7,04	154	EEN002	consultar	240
9 3653 25 01	12,11	155	9 4519 25 02	7,04	154	EEN003	consultar	240
9 3653 25 05	12,11	155	9 4519 25 05	7,04	154	EG001	130,00	240
9 3653 25 07	12,11	155	9 4519 25 06	7,04	154	EG003U	consultar	240
9 3653 25 09	12,11	155	9 4557 05	2,73	154	EG004	consultar	240
9 3653 25 10	12,11	155	9 4557 25 05	2,00	154	E		
9 3653 25 24	26,72	155	9 4557 25 07	2,00	154	EG005	consultar	240
9 3653 25 68	26,72	155	9 4557 25 09	2,73	154	EK028	20,00	241
9 3655 25 01	12,09	155	9 4559 05	2,52	154	EK088	46,31	241
9 3655 25 05	12,09	155	9 4559 25 05	2,52	154	EK089	35,00	241
9 3655 25 07	12,09	155	9 4559 25 07	2,52	154	EK090	26,90	203
9 3655 25 09	12,09	155	9 4559 25 09	2,52	154	EK760	113,96	219
9 3655 25 10	12,09	155	9 4560 05	13,97	154	EK771	17,10	219
9 3655 25 24	24,88	155	9 4560 25 01	13,97	154	EK772	17,10	219
9 3655 25 68	24,88	155	9 4560 25 02	13,97	154	EK773	17,10	219
9 3656 25 01	9,04	155	9 4560 25 05	13,97	154	EK774	17,10	219
9 3656 25 05	9,04	155	9 4560 25 06	13,97	154	EK775	19,37	219
9 3656 25 07	9,04	155	9 4561 25 02	13,97	154	EXP0053C	350,00	133
9 3656 25 09	9,04	155	9 4581 25 01	7,35	154			
9 3656 25 10	9,04	155	9 4581 25 02	7,35	154	S		
9 3656 25 24	16,94	155	9 4581 25 03	7,35	154	ST312	consultar	236
9 3656 25 68	16,94	155	9 4581 25 05	7,35	154			
9 3657 25 01	16,29	155	9 4581 25 06	7,35	154	T		
9 3657 25 05	16,29	155	9 6184 05	7,89	153	TCC510S	163,20	241
9 3657 25 07	16,29	155	9 6185 05	7,56	153	TCC520E	213,18	241
9 3657 25 09	16,29	155	9 6184 25 01	7,89	153	TCC521E	256,94	241
9 3657 25 10	16,29	155	9 6184 25 02	7,89	153	TCC530E	214,20	241
9 3657 25 24	22,14	155	9 6184 25 05	7,89	153	TE331	140,00	241
9 3657 25 68	22,14	155	9 6185 25 01	7,56	153	TE332	195,00	241
9 3671 25 01	7,77	155	9 6185 25 02	7,56	153	TE360	417,38	241
9 3671 25 05	7,77	155	9 6185 25 05	7,56	153	TE370	406,57	241
9 3671 25 07	7,77	155	9 6185 25 06	7,56	153	TG008	1,19	236
9 3671 25 09	7,77	155	9 6194 05	8,91	153	TG018	101,90	236
9 3671 25 10	7,77	155	9 6194 25 02	8,91	153	TG019	489,83	236
9 3671 25 24	16,90	155	9 6194 25 05	8,91	153	TG025	1,19	236
9 3671 25 68	16,90	155	9 6194 25 06	8,91	153	TG029	64,77	237
9 3675 25 01	13,34	155	9 6195 05	7,94	153	TG053A	997,25	240
9 3675 25 05	13,34	155	9 6195 25 01	7,94	153	TG060	269,99	236
9 3675 25 07	13,34	155	9 6195 25 02	7,94	153	TG061	1.349,97	236
9 3675 25 09	13,34	155	9 6195 25 05	7,94	153	TG200A	28,76	236
9 3675 25 10	13,34	155	9 6195 25 06	7,94	153	TG200B	28,76	236
9 3675 25 24	29,08	155	9 6249 05	18,42	153	TG200C	28,76	236
9 3675 25 68	29,08	155	9 6249 25 01	18,42	153	TG308	8,77	237

Referencia	Precio €	Pág. tarifa	Referencia	Precio €	Pág. tarifa	Referencia	Precio €	Pág. tarifa
T			T			W		
TG353	73,04	240	TXA661B	187,95	231	WL0020	4,58	40
TG354	37,92	240	TXA662AN	260,00	231	WL0021	4,58	40
TG401	4,95	219	TXA663A	346,50	231	WL0030	9,37	40
TG402	6,63	219	TXA664AN	420,00	231	WL0031	9,37	40
TG403	7,65	219	TXB302	57,94	237	WL0040	6,31	40
TG510A	102,31	241	TXB304	105,57	237	WL0041	6,31	40
TG511A	125,26	241	TXB322	59,67	237	WL0050	7,28	40
TG540A	110,26	241	TXB344	108,73	237	WL0051	7,28	40
TG541A	131,38	241	TXB601B	62,00	231	WL0060	10,58	40
TGA200	183,70	236	TXB602F	80,00	231	WL0061	10,58	40
TGM600E	8,23	231	TXB692F	92,61	231	WL0070	9,46	40
TGM616D	11,26	231	TXC511	271,22	241	WL0071	9,46	40
TGM620D	15,16	231	TXE531	649,00	231	WL0110	5,49	40
TH101	241,13	237	TXE771	102,56	241	WL0111	5,49	40
TH103	20,64	237	TXE773	170,94	241	WL0210	4,31	40
TH210	606,80	237	TXM616D	535,00	231	WL0211	4,31	40
TJA450	1.150,00	244	TXM620D	600,00	231	WL0220	5,31	40
TJA451	1.275,00	244	TXM632C	535,00	231	WL0221	5,31	40
TJA560	704,00	244	TYA604A	231,72	238	WL0240	7,31	40
TJA665	499,00	227	TYA604B	278,09	238	WL0241	7,31	40
TP110	107,30	236	TYA604C	370,71	238	WL0310	15,50	40
TR131A	219,10	237	TYA604D	383,55	238	WL0311	15,50	40
TR131B	225,72	237	TYA606A	322,00	238	WL0320	15,76	40
TR140A	213,28	237	TYA606B	362,25	238	WL0321	15,76	40
TR140B	219,61	237	TYA606C	396,80	238	WL0410	9,88	40
TR351A	174,93	237	TYA606D	409,84	238	WL0411	9,88	40
TRB201	94,45	219	TYA606E	437,66	238	WL0510	19,75	44
TRB302B	76,26	219	TYA608A	395,88	238	WL0511	19,75	44
TRC270D	115,46	219	TYA608B	433,48	238	WL1040	6,50	41
TRC301B	71,40	219	TYA608C	475,00	238	WL1041	6,50	41
TRC321B	81,60	219	TYA608D	498,29	238	WL1060	4,03	41
TRE201	116,44	219	TYA610A	478,22	238	WL1061	4,03	41
TRE202	145,55	219	TYA610B	514,70	238	WL1160	7,83	41
TRE221	131,00	219	TYA610C	569,32	238	WL1161	7,83	41
TRE301	71,40	219	TYA610D	588,57	238	WL2010	9,56	42
TRE302	81,60	219	TYA624A	271,05	239	WL2011	9,56	42
TRE400	123,73	219	TYA624B	279,41	239	WL2020	17,50	42
TRE520	142,80	219	TYA624C	342,79	239	WL2021	17,50	42
TRE521	149,94	219	TYA624D	359,61	239	WL2110	14,50	42
TRE530	171,36	219	TYA628A	478,22	239	WL2111	14,50	42
TRE531	179,93	219	TYA628C	594,48	239	WL2120	29,00	42
TRE600	283,34	219	TYA661AN	217,86	239	WL2121	29,00	42
TRE720	228,13	219	TYA661BN	294,59	239	WL2150	16,00	42
TRM600	84,47	219	TYA662AN	390,00	239	WL2151	16,00	42
TRM690G	77,18	219	TYA663AN	538,34	239	WL2160	34,00	42
TRM691E	91,06	219	TYA664AN	575,50	239	WL2161	34,00	42
TRM692G	71,97	219	TYA664BN	690,60	239	WL2170	20,00	42
TRM693G	66,12	219	TYA670D	570,00	239	WL2171	20,00	42
TRM694G	82,71	219	TYA720	410,00	240	WL2180	41,00	42
TRM702A	49,28	219	TYB601B	91,71	238	WL2181	41,00	42
TU402	47,33	219	TYB602F	108,12	238	WL2210	18,04	42
TU404	62,73	219	TYB673A	251,20	239	WL2211	18,04	42
TU406	78,54	219	TYB673B	266,30	239	WL2320	4,00	42
TU418	101,24	219	TYB692F	119,53	239	WL2321	4,00	42
TX206H	481,03	240	TYB708D	123,00	237	WL2410	7,73	42
TX211A	307,12	239	TYC120	459,00	237	WL2411	7,73	42
TX320	181,46	240	TYF120	250,00	237	WL2510	3,52	44
TX501	230,21	240	TYF130	371,48	237	WL2511	3,52	44
TX502	329,05	240	TYF642F	326,40	240	WL3010	17,83	43
TX510	234,80	241	TYF646M	385,00	239	WL3011	17,83	43
TXA022	214,81	240	TYF656T	255,00	240	WL3020	17,83	43
TXA025	208,39	240	TYF684	397,80	239	WL3021	17,83	43
TXA100	599,00	227	TYF684E	346,80	239	WL3110	19,32	43
TXA111	263,16	236	TYF784	275,40	237	WL3111	19,32	43
TXA112	326,60	236	TYF784E	224,40	237	WL3120	19,32	43
TXA114	340,22	236				WL3121	19,32	43
TXA116	414,65	236				WL3310	9,50	44
TXA304	180,44	237	W			WL3311	9,50	44
TXA306	317,12	237	WDI070	1.260,00	245	WL4010	48,29	44
TXA310	431,77	237	WDI100	1.690,00	245	WL4011	48,29	44
TXA604D	245,70	231	WDI101	3.455,00	245	WL4012	48,29	44
TXA606B	228,90	231	WDI161	3.750,00	245	WL4030	48,29	44
TXA606D	270,90	231	WDW070	80,00	245	WL4031	48,29	44
TXA608B	277,20	231	WDW071	160,00	245	WL5010	0,94	41
TXA608D	311,85	231	WDW100	95,00	245	WL5011	0,94	41
TXA610B	333,90	231	WDW101	190,00	245	WL5120	1,70	41
TXA610D	375,90	231	WDW160	110,00	245	WL5121	1,70	41
TXA624C	208,95	231	WDW161	250,00	245	WL5130	2,73	41
TXA624D	243,60	231	WK696	0,88	166	WL5131	2,73	41
TXA628C	370,65	231	WK697	1,01	166	WL5140	4,87	41
TXA661A	139,65	231	WL0010	3,72	40	WL5141	4,87	41
			WL0011	3,72	40	WL5150	6,70	41

Tabla de correspondencia

Referencia - Precio - Página tarifa



Referencia	Precio €	Pág. tarifa	Referencia	Precio €	Pág. tarifa	Referencia	Precio €	Pág. tarifa
W			W			W		
WL5151	6,70	41	WNA401B	8,17	167	WNT912B	6,13	168
WL5220	1,70	41	WNA402	11,35	167	WNT922	9,96	168
WL5221	1,70	41	WNA402B	11,24	167	WNT922B	9,99	168
WL5230	2,73	41	WNA403	18,98	167	WNT932	5,67	168
WL5231	2,73	41	WNA403B	19,43	167	WNT932B	6,13	168
WL5240	4,87	41	WNA408	11,35	167	WNT942	5,67	168
WL5241	4,87	41	WNA408B	11,24	167	WNT942B	6,13	168
WL5250	6,70	41	WNA450	8,25	166	WNT944	6,79	168
WL5251	6,70	41	WNA455	14,14	166	WNT944B	8,19	168
WL5310	1,01	44	WNA455B	14,57	166	WNT954	13,86	168
WL5311	1,01	44	WNA601	40,40	165	WNT954B	13,98	168
WL5410	4,86	45	WNA602	40,40	165	WNT964	6,60	168
WL5411	4,86	45	WNA603	40,40	165	WNT964B	7,10	168
WL5420	3,47	45	WNA681	3,30	167	WNT974	6,60	168
WL5421	3,47	45	WNA681B	3,52	167	WNT974B	7,10	168
WL6010	1,50	45	WNA682	12,16	167	WNT982	6,60	168
WL6011	1,50	45	WNA682B	13,08	167	WNT982B	7,10	168
WL6020	1,50	45	WNA683	18,68	167	WS604	1,75	165
WL6021	1,50	45	WNA683B	19,24	167	WS605	1,75	165
WL6030	1,50	45	WNA684	3,30	167	WS606	1,75	165
WL6031	1,50	45	WNA685	12,16	167	WS607	23,56	165
WL6110	1,65	45	WNA685B	13,08	167	WS608	1,75	165
WL6111	1,65	45	WNA686	12,16	167	WS609	1,75	165
WL6120	1,65	45	WNA686B	13,08	167	WUZ681	4,55	166
WL6121	1,65	45	WNA689	1,00	167	WUZ682	4,55	166
WL6130	1,65	45	WNA690	1,59	167	WUZ686	4,55	166
WL6131	1,65	45	WNA690B	1,07	167	WUZ687	4,55	166
WL6320	3,80	43	WNA691	1,00	167	WUZ690	6,06	166
WL6321	3,80	43	WNA691B	1,07	167	WUZ691	5,05	166
WL7010	5,94	44	WNA693	8,08	167	WUZ692	4,14	166
WL7011	5,94	44	WNA694	2,12	167	WUZ695	7,07	166
WL7023	3,21	41	WNA695	35,35	166	WUZ696	6,57	166
WNA001	6,84	165	WNA696	35,35	166	WUZ697	4,14	166
WNA001B	7,41	165	WNA697	36,36	166	WUZ698	5,05	166
WNA002	14,83	165	WNA698	36,36	166	WUZ699	5,05	166
WNA002B	15,20	165	WNA699	58,59	166			
WNA003	14,61	165	WNA700	9,60	167			
WNA003B	15,42	165	WNC001	9,14	164			
WNA006	15,66	165	WNC001B	9,49	164			
WNA006B	16,13	165	WNC002	16,67	164			
WNA008	14,83	165	WNC003	16,73	164			
WNA008B	15,27	165	WNC020	10,94	164			
WNA010	23,67	165	WNC021	16,34	164			
WNA010B	24,38	165	WNC022	13,67	164			
WNA020	9,45	165	WNC023	16,34	164			
WNA020B	9,70	165	WNC025	18,64	164			
WNA021	14,80	165	WNC032	92,87	164			
WNA021B	15,25	165	WNC033	70,71	164			
WNA022	12,33	165	WNC035	91,36	164			
WNA022B	12,76	165	WNC036	125,54	164			
WNA023	14,80	165	WNC040	19,26	164			
WNA023B	15,25	165	WNC041	25,09	164			
WNA025	19,78	165	WNC044	21,22	164			
WNA025B	20,46	165	WNC155	17,32	164			
WNA032	91,82	165	WNC155B	17,72	164			
WNA033	74,75	165	WNC161	11,79	164			
WNA035	71,72	165	WNC161B	12,52	164			
WNA036	83,45	165	WNC164	27,32	164			
WNA037	85,86	165	WNC165	40,96	164			
WNA037B	88,43	165	WNC174	27,32	164			
WNA038	14,14	166	WNC455	15,15	164			
WNA040	17,37	165	WNC455B	15,15	164			
WNA040B	18,06	165	WNE001	14,74	164			
WNA041	26,37	165	WNE001B	14,96	164			
WNA041B	27,72	165	WNE023	21,79	164			
WNA044	18,16	165	WNE023B	22,74	164			
WNA044B	18,78	165	WNE025	26,57	164			
WNA045	28,72	165	WNE025B	26,95	164			
WNA045B	29,71	165	WNE040	22,36	164			
WNA100	10,02	165	WNE040B	23,03	164			
WNA155	16,16	165	WNE155	27,96	164			
WNA155B	16,65	165	WNE155B	28,97	164			
WNA157	13,13	165	WNE161	16,98	164			
WNA157B	13,53	165	WNE161B	17,83	164			
WNA161	10,10	165	WNT302	80,15	168			
WNA161B	10,39	165	WNT304	85,19	168			
WNA300	28,53	165	WNT331	83,63	168			
WNA300B	29,38	165	WNT332	95,99	168			
WNA301	26,74	165	WNT902	4,73	168			
WNA301B	30,36	165	WNT902B	5,20	168			
WNA401	7,98	167	WNT912	5,67	168			

Nuevo producto,
ref. en color azul

Esta tarifa anula la anterior:

Tarifa 704- noviembre 2016
(DC 338.d E-16)

Referencia	Precio €	Referencia	Precio €	Referencia	Precio €
1029 00 02	9,79	1804 25	2,45	4586	25,50
1030 00 02	10,50	1805 05	2,86	4587	33,46
1031 00 02	12,44	1806	4,08	4594	37,33
1241	4,18	1807	1,43	4631	89,36
1241 01	4,18	1808	1,53	4768 05	110,67
1241 02	4,18	1861	2,86	4769 05	52,53
1241 03	4,18	1880	1,84	4781 05	27,85
1248 19 00	22,64	1881	1,02	4784 05	28,25
1248 60 86	23,62	1882	1,53	4789 05	107,71
1248 60 89	22,75	1886	4,79	4790 05	35,50
1248 70 03	33,31	1889 05	2,45	5071 05	20,91
1248 70 04	33,31	1906	3,37	5075 05	33,56
1248 70 06	23,03	1962 05	6,02	5075 15	24,07
1248 70 09	22,75	2045 20 45	220,43	5076 05	9,28
1404 03 01	12,44	2045 20 89	220,30	5076 55	16,93
1404 03 02	14,38	2895 05	123,35	5112 15	18,97
1404 03 04	14,38	2951	140,17	5152	33,86
1405 03 01	10,10	2952	140,17	5172 15	20,40
1405 03 02	7,55	2970 10	185,41	61 1891 05	4,39
1405 03 69	7,55	3045	41,21	61 1960 05	9,41
1405 71 03	7,65	3046	32,54	61 1961 05	14,69
1405 71 04	7,65	3072 05	21,11	61 1963 05	13,28
1405 71 06	7,65	3075 05	10,81	61 3076 15	9,28
1405 71 09	7,15	3075 25	34,17	61 4740 15	6,94
1434 03 01	16,63	3076 05	6,83	67 1932 05	13,67
1434 03 02	12,44	3076 25	20,81	7514 10 00	67,92
1434 03 04	17,85	3076 55	15,81	7514 11 00	71,80
1435 03 01	14,38	3077 05	11,53	7514 12 26	128,01
1435 03 02	11,53	3078 05	21,83	7514 12 29	128,01
1435 03 69	11,53	3142	51,61	7514 13 26	156,18
1435 72 03	16,01	3146	44,17	7514 13 29	156,18
1435 72 04	11,32	3172 05	34,07	7514 20 00	69,45
1435 72 06	11,32	3176 05	12,34	7514 21 00	86,74
1435 72 09	10,93	3242 25	55,59	7514 22 26	137,99
1611	5,61	3271 05	82,42	7514 22 29	137,99
1613	7,45	3272 05	90,68	7514 23 26	166,86
1614	7,45	3272 15	90,68	7514 23 29	166,86
1619 01	16,47	3273	51,92	7514 32 26	155,21
1620 14 14	8,00	3562 05	35,90	7514 32 29	155,21
1620 16 16	5,20	3566 05	27,54	7514 33 26	181,07
1620 19 19	4,69	3976 15	30,60	7514 33 29	181,07
1620 60 76	5,10	4123 14 04	13,10	7514 42 26	165,42
1620 60 79	3,67	4123 16 06	9,60	7514 42 29	165,42
1620 89 12	4,18	4123 19 09	8,20	7514 43 26	195,84
1620 89 19	4,18	4123 20 45	8,50	7514 43 29	195,84
1644 14 04	11,90	4123 20 89	7,80	7516 10 42	45,16
1644 16 06	9,20	4123 60 86	8,60	7516 10 43	51,03
1644 19 09	8,36	4123 60 89	8,60	7516 10 44	51,03
1644 20 45	8,76	4123 89 82	7,90	7516 10 49	45,84
1644 20 89	5,38	4123 89 89	7,90	7516 11 42	42,75
1644 60 86	9,14	4134 00 01	11,22	7516 11 43	47,61
1644 60 89	10,40	4134 00 02	11,22	7516 11 44	47,61
1644 89 82	7,75	4134 00 04	11,80	7516 11 49	43,50
1644 89 89	7,75	4135 00 01	10,90	7516 13 70	45,84
1681 00	133,91	4135 00 02	9,20	7516 13 73	51,03
1681 05	133,91	4135 00 69	9,20	7516 13 74	49,46
1681 07	133,91	4135 70 03	12,70	7516 13 75	47,90
1682 00	143,95	4135 70 04	12,70	7516 13 80	45,84
1682 05	143,95	4135 70 06	9,00	7516 13 85	47,90
1682 07	143,95	4135 70 09	8,87	7516 16 42	73,26
1683 00	237,05	4227 05	142,49	7516 16 43	77,85
1683 05	237,05	4228 05	135,66	7516 16 44	77,85
1683 07	237,05	4240 05	8,36	7516 16 49	74,01
1684 00	237,05	4241 15	26,01	7516 17 70	74,01
1684 05	237,05	4256 15	16,42	7516 17 73	77,85
1684 07	237,05	4270 05	26,72	7516 17 74	78,17
1685 78	547,13	4270 15	30,29	7516 17 75	75,71
1691 00	227,54	4273 05	47,74	7516 17 80	74,01
1691 05	227,54	4275 05	26,62	7516 17 85	75,71
1691 07	227,54	4275 15	30,40	7516 20 42	54,99
1692 00	229,11	4283	60,28	7516 20 43	61,15
1692 05	229,11	4342	94,66	7516 20 44	61,15
1692 07	229,11	4376 05	25,40	7516 20 49	55,82
1693 00	280,60	4502	15,30	7516 21 42	52,65
1693 05	280,60	4503	4,59	7516 21 43	57,52
1693 07	280,60	4515	26,72	7516 21 44	57,52
1694 00	280,60	4515 10	26,72	7516 21 49	53,37
1694 05	280,60	4522	15,30	7516 23 70	55,82
1694 07	280,60	4523	31,62	7516 23 73	61,15
1804 05	2,45	4554	26,62	7516 23 74	59,90
1804 15	2,45	4555	32,64	7516 23 75	58,02

Tabla de correspondencia

Referencia - Precio (Referencias antiguas o a punto de expirar)



Referencia	Precio €	Referencia	Precio €	Referencia	Precio €
7516 23 80	55,82	7526 12 71	98,76	7586 00 29	242,63
7516 23 85	58,02	7526 12 73	101,51	7586 00 42	240,36
7516 26 42	83,95	7526 12 75	95,45	7586 00 43	246,21
7516 26 43	88,93	7526 12 79	95,13	7586 00 44	246,21
7516 26 44	88,93	7526 12 83	99,68	7586 00 49	242,63
7516 26 49	84,70	7526 12 85	97,47	7586 00 52	240,36
7516 27 70	84,70	7526 12 89	95,13	7586 00 59	242,63
7516 27 73	88,93	7526 15 26	135,59	7586 00 71	253,15
7516 27 74	89,20	7526 15 29	135,59	7586 00 73	246,21
7516 27 75	86,39	7526 15 42	134,85	7586 00 75	243,45
7516 27 80	84,70	7526 15 43	141,18	7586 00 79	242,63
7516 27 85	86,39	7526 15 44	141,18	7586 00 83	245,72
7516 33 70	73,06	7526 15 49	135,59	7586 00 85	243,45
7516 33 73	78,21	7526 15 52	134,85	7586 00 89	242,63
7516 33 74	77,46	7526 15 59	135,59	7590 00 32	46,43
7516 33 75	75,02	7526 15 71	145,77	7594 02 42	6,62
7516 33 80	73,06	7526 15 73	141,18	7594 02 43	10,63
7516 33 85	75,02	7526 15 75	135,86	7594 02 44	10,63
7516 37 70	98,90	7526 15 79	135,59	7594 02 49	7,89
7516 37 73	104,08	7526 15 83	140,45	7596 00 03	11,54
7516 37 74	104,16	7526 15 85	137,62	7596 00 04	9,56
7516 37 75	100,89	7526 15 89	135,59	7596 00 05	9,77
7516 37 80	98,90	7526 16 26	135,59	7596 00 06	9,52
7516 37 85	100,89	7526 16 29	135,59	8524 51 26	130,10
7516 40 42	82,42	7526 16 42	134,85	8524 51 29	126,27
7516 40 43	89,48	7526 16 43	141,18	8524 51 31	127,33
7516 40 44	89,48	7526 16 44	141,18	8524 51 39	127,33
7516 40 49	83,26	7526 16 49	135,59	8524 51 73	134,48
7516 41 42	80,17	7526 16 52	134,85	8524 51 75	131,06
7516 41 43	85,38	7526 16 59	135,59	8524 51 77	134,48
7516 41 44	85,38	7526 16 71	141,38	8524 51 79	127,23
7516 41 49	80,86	7526 16 73	141,18	8524 51 82	126,27
7516 43 70	83,26	7526 16 75	135,86	8524 51 83	133,52
7516 43 73	89,48	7526 16 79	135,59	8524 51 85	130,10
7516 43 74	87,73	7526 16 83	140,45	8524 51 88	126,27
7516 43 75	84,97	7526 16 85	137,62	8524 51 89	126,27
7516 43 80	83,26	7526 16 89	135,59	8 6263 25 03	18,41
7516 43 85	84,97	7544 11 26	263,77	9 6184 25 06	7,89
7516 46 42	112,92	7544 11 29	263,77	9 6194 25 01	8,91
7516 46 43	117,25	7544 11 42	262,95	9 6272 25 01	13,08
7516 46 44	117,25	7544 11 43	268,35		
7516 46 49	113,69	7544 11 44	268,35	T	
7516 47 70	113,69	7544 11 49	263,77	TJ060B	3.434,66
7516 47 73	117,25	7544 11 52	262,95	TJ061B	205,77
7516 47 74	119,37	7544 11 59	263,77	TRB210	130,08
7516 47 75	115,62	7544 11 71	274,27	TRB221A	91,50
7516 47 80	113,69	7544 11 73	268,35	TRB302A	59,25
7516 47 85	115,62	7544 11 75	264,60	TRB501	110,26
7516 87 42	135,46	7544 11 79	263,77	TRB521	102,82
7516 87 43	140,45	7544 11 83	267,59	TX450A	270,50
7516 87 44	140,45	7544 11 85	264,60	TX450B	274,89
7516 87 49	136,26	7544 11 89	263,77	TX460A	275,30
7516 88 70	136,26	7544 12 42	225,56	TX460B	281,21
7516 88 73	140,45	7544 12 43	230,78	TXA215	375,26
7516 88 74	142,67	7544 12 44	230,78	TXA664A	409,50
7516 88 75	138,18	7544 12 49	226,36	TXE530	599,00
7516 88 80	136,26	7566 27 26	307,96	TYA661A	217,86
7516 88 85	138,18	7566 27 29	307,96	TYA661B	294,59
7526 11 26	95,13	7566 27 70	225,81	TYA663A	538,34
7526 11 29	95,13	7566 27 73	230,97	TYA664A	575,50
7526 11 42	94,37	7566 27 74	235,17	TYB601A	91,71
7526 11 43	101,51	7566 27 75	227,77	TYB602A	108,12
7526 11 44	101,51	7566 27 80	225,81	TYB621C	119,53
7526 11 49	95,13	7566 27 85	227,77	TYB641A	212,10
7526 11 52	94,37	7566 37 26	357,23	TYB691F	204,00
7526 11 59	95,13	7566 37 29	357,23	TYB692C	199,00
7526 11 71	98,76	7566 37 70	275,06	TYF646T	255,00
7526 11 73	101,51	7566 37 73	280,25		
7526 11 75	95,45	7566 37 74	286,06		
7526 11 79	95,13	7566 37 75	277,05		
7526 11 83	99,68	7566 37 80	275,06		
7526 11 85	97,47	7566 37 85	277,05		
7526 11 89	95,13	7566 57 26	430,28		
7526 12 26	95,13	7566 57 29	430,28		
7526 12 29	95,13	7566 57 70	348,12		
7526 12 42	94,37	7566 57 73	353,29		
7526 12 43	101,51	7566 57 74	361,45		
7526 12 44	101,51	7566 57 75	350,07		
7526 12 49	95,13	7566 57 80	348,12		
7526 12 52	94,37	7566 57 85	350,07		
7526 12 59	95,13	7586 00 26	242,63		

1. Objeto y ámbito de aplicación

1.1 – Al realizar un pedido, el cliente acepta plenamente y sin reservas las presentes Condiciones Generales, que prevalecerán sobre cualquier otro documento del cliente y, en particular, sobre cualesquiera otras condiciones generales, salvo expreso acuerdo previo en contra por escrito de HAGER SISTEMAS S.A.U. (en adelante, HAGER).

1.2 – HAGER podrá otorgar por escrito condiciones especiales para el cliente cuando así lo justifiquen las circunstancias específicas de la operación.

2. Contratación - pedidos

2.1 - Definiciones

2.1.1 – HAGER es una sociedad debidamente constituida con arreglo a la legislación española, con domicilio social en la calle Alfred Nobel, 18, Pol. Ind. Valloriolf, Apartado 39, E-08430 La Roca del Vallés (Barcelona, España).

2.1.2 – Se entenderá por “cliente” cualquier cliente profesional o empresarial que realice un pedido de compra de productos de HAGER.

2.1.3 – Se entenderá por “pedido” cualquier pedido de compra de productos de HAGER formulado por el cliente.

2.1.4 – Se entenderá por “contrato de venta” el contrato celebrado entre HAGER y sus clientes mediante la aceptación escrita por HAGER del pedido de compra formulado por el cliente.

2.2 - Modificación del pedido

2.2.1 – Los pedidos recibidos y aceptados por HAGER serán irrevocables para el cliente, a menos que HAGER convenga otra cosa por escrito.

2.2.2 – El cliente deberá presentar una solicitud escrita para modificar la composición o el volumen del pedido. Para que surta efecto la modificación del pedido, HAGER deberá aceptar la petición por escrito (incluido correo electrónico o fax). El cliente reconoce expresamente que la aceptación de la solicitud de modificación del pedido podrá resultar del envío de los productos correspondientes al nuevo pedido.

2.2.3 – Si un cliente formula un pedido sin haber pagado previamente los pedidos anteriores, HAGER podrá negarse a atender los pedidos aceptados y a entregar los productos en cuestión sin ninguna clase de indemnización al cliente por ningún concepto.

2.3 - Solvencia del cliente - pago en efectivo

La aceptación de los pedidos por HAGER está sujeta en todos los casos a que el cliente aporte garantías financieras suficientes con arreglo a la legislación aplicable.

Si HAGER considerase razonablemente que el cliente puede encontrarse en dificultades económicas en la fecha de formulación del pedido, podrá aceptar el pedido exclusivamente previo pago en efectivo o aportación de garantías a su favor por el cliente.

Antes de aceptar pedidos, HAGER podrá solicitar también al cliente que presente documentación contable, en particular su cuenta de resultados, aunque sean previsiones, con el fin de evaluar su solvencia.

HAGER podrá rechazar los pedidos cursados si el cliente se negara a pagar en efectivo sin proponer la prestación de garantías suficientes.

3. Entrega

3.1 - Definición

La entrega se considerará producida en el momento del traspaso físico de los productos en las instalaciones o los almacenes del cliente.

En el caso de que el cliente se encargue del transporte de la mercancía, la entrega se considerará producida en el momento del traspaso físico al cliente, o al transportista designado por este, de los productos en las instalaciones o los almacenes de HAGER.

HAGER podrá realizar entregas completas o parciales. En caso de entrega parcial de un pedido, la parte no entregada no justificará la demora en el pago de la parte entregada.

3.2 - Riesgos

Los términos de entrega, transporte y transmisión del riesgo de pérdida y/o daños de los Productos y los documentos se regirán por el Incoterm 2010 DAP, salvo que el cliente se encargue el transporte de la mercancía, en cuyo caso será de aplicación el Incoterm 2010 EXW.

3.3 - Transporte por cuenta de HAGER

Los pedidos con un valor superior a 500€ se enviarán a portes pagados.

Los pedidos de importe inferior podrán viajar con porte a cargo de HAGER mediante recargo en factura del 5% sobre el valor neto del pedido, con un mínimo de 12€.

Dependiendo de las alternativas de envío disponibles, HAGER elegirá el modo de transporte más económico según su criterio.

Los plazos del transporte se ofrecen exclusivamente a título informativo e indicativo, pues dependen, en particular, de la disponibilidad de los transportistas y del orden de llegada de los pedidos.

En todo caso, HAGER tratará de cumplir los plazos de entrega indicados al aceptar el pedido, según los plazos de entrega logísticos de referencia en el sector, y de atender los pedidos, excepto en caso de fuerza mayor, conforme a la definición de la cláusula 13, o circunstancias ajenas a su control.

3.4 - Cantidades

Los materiales serán suministrados por embalajes completos conteniendo las cantidades indicadas en nuestras tarifas, excepto los indicados con el símbolo  con embalaje divisible.

3.5 - Plazo de entrega

La demora en la entrega no dará lugar a ninguna penalización, compensación o indemnización de daños y perjuicios, ni justificará la cancelación del pedido formulado por el cliente y registrado por HAGER.

No serán vinculantes para HAGER las cláusulas de penalización que puedan aparecer en los documentos comerciales de los clientes.

3.6 - HAGER se reserva el derecho de suspender las entregas en curso o futuras si una factura vencida que no ha sido totalmente pagada continuara impagada transcurridas cuarenta y ocho (48) horas desde el requerimiento formal de pago de la misma.

4. Recepción de la entrega - Comunicación de defectos aparentes y/o artículos no conformes y/o falta de artículos

4.1 – Si los productos entregados tuvieran defectos aparentes o no fueran conformes, o si faltaran artículos respecto a los señalados en el pedido aceptado por HAGER, el cliente deberá manifestarlo y confirmar su reclamación por escrito (incluido correo electrónico, fax, requerimiento notarial y carta certificada con acuse de recibo) al transportista en el plazo de cuatro (4) días hábiles desde su recepción.

4.2 – Sin perjuicio de las medidas a adoptar con respecto al transportista descritas en el apartado 4.1, en caso de defectos aparentes o falta de conformidad de los productos entregados o falta de algún artículo, HAGER sólo aceptará aquellas reclamaciones con respecto a los productos entregados que se realicen por escrito (incluido correo electrónico, fax y carta certificada con acuse de recibo) en el plazo de cuatro (4) días hábiles anteriormente establecido en el citado apartado 4.1.

4.3 – Los productos que no hayan sido objeto de reclamación en la forma y en los plazos anteriormente señalados, con envío simultáneo de copia de dicha reclamación a HAGER, se considerarán definitivamente aceptados por el cliente. El cliente no podrá adoptar ninguna otra medida al margen de las señaladas anteriormente para reclamar por defectos aparentes o falta de artículos.

4.4 – El cliente tendrá la carga de probar la existencia de defectos o la falta de artículos. El cliente prestará a HAGER la asistencia necesaria para determinar la existencia de defectos y, en su caso, para subsanarlos.

4.5 – El cliente no podrá devolver productos sin la previa y expresa aceptación de HAGER tanto respecto a la propia devolución como a sus términos económicos y operativos. La aceptación deberá obtenerse, en particular, por fax o correo electrónico.

HAGER sólo asumirá los gastos de devolución de los productos una vez que la propia HAGER o su agente autorizado concluyan que existe un defecto aparente o la falta de algún artículo.

4.6 – Si tras la inspección, HAGER o su agente autorizado constataran efectivamente la existencia de un defecto aparente o la falta de uno o más artículos, HAGER sustituirá los productos no conformes o aportará los que falten a su costa, sin que el cliente tenga derecho a indemnización alguna ni posibilidad de cancelar el pedido.

4.7 – La aceptación en virtud de la recepción sin reclamación alguna por el cliente de la entrega de los productos encargados cubre todos los defectos aparentes y la falta de artículos. Cualquier reclamación deberá realizarse según las condiciones establecidas en la cláusula 4.2.

4.8 – Las reclamaciones y requerimientos del cliente con arreglo a las condiciones y en los términos establecidos en esta cláusula 4 no suspenderán el pago de los productos en cuestión.

5. Devoluciones de artículos sin defectos

5.1 – Se aceptarán devoluciones de referencias publicadas en Tarifa PVP en vigor transcurrido un plazo inferior a 18 meses entre la fecha del albarán y la fecha de la devolución.

5.2 – La devolución del material abonable sufrirá una depreciación del 15% en concepto de gestión.

5.3 – Sólo se admitirán las devoluciones aceptadas previamente por HAGER. Para la aceptación de las mismas será necesario remitir el formulario HAGER de devolución (por correo electrónico, fax o carta certificada con acuse de recibo), firmado por el comercial de HAGER asignado, y autorizado por Dirección Comercial.

5.4 – Sólo se admitirán devoluciones en embalajes completos, etiquetados y referenciados.

Las devoluciones de productos de canalización se efectuarán sólo en embalajes completos, sobre palet si es más de un embalaje y con protección de film plástico sobre el mismo.

Las devoluciones de armarios se harán sobre palet y con embalaje protector completo.

5.5 – En caso de devolución por error en el pedido o por razones ajenas a HAGER, la mercancía y el embalaje de la misma deberán encontrarse en perfectas condiciones para su reventa y estar referenciada en la tarifa vigente. La mercancía será abonada a su valor neto, cargándose un demérito del 15% en concepto de participación en los costes de revisión y manipulado y descontándose, si ha lugar, otros costes derivados del mal estado de la misma.

5.6 – En ningún caso se admitirán devoluciones de materiales que hayan sido utilizados, montados en otros equipos o instalaciones, o con evidencias de haber sido manipulados. Tampoco se admitirá la devolución de aquellos materiales en los que HAGER haya realizado alguna adaptación específica para el pedido.

5.7 – Las devoluciones o envíos de material sin defectos a las instalaciones de HAGER, deberán efectuarse siempre por cuenta, riesgo y cargo del cliente.

6. Lista de precios - Precios

6.1 - Lista de precios

6.1.1 – La lista de precios de HAGER es aplicable a todos sus clientes en una determinada fecha, salvo estipulación en contrario en una negociación comercial entre HAGER y el cliente. Los precios de la lista podrán revisarse al alza durante el año, previa notificación a los clientes de HAGER.

6.1.2 – Los cambios de precio serán aplicables automáticamente en la fecha señalada en la nueva lista de precios de HAGER.

6.2 - Precios

6.2.1 – Los precios aplicables son los establecidos en la lista de precios aplicable en la fecha de solicitud del pedido.

6.2.2 – Los precios no incluyen el IVA, aranceles u otros impuestos aplicables a los productos relativos a la operación de venta ni los costes de la entrega, según se define en la cláusula 3.

Los precios incluyen el coste del empaquetado, excepto en el caso de empaquetados especiales. Salvo pacto en contrario, HAGER selecciona y prepara el empaquetado y no lo recoge de vuelta.

6.2.3 – El importe mínimo de pedido es de cien euros (100€), IVA no incluido.

7. Condiciones de pago

7.1 - Pago

7.1.1 – A menos que HAGER y el cliente acuerden otra cosa como resultado de una negociación comercial, las facturas de HAGER se pagarán en el plazo de cuarenta y cinco (45) días naturales desde la fecha de recepción de los productos. La factura indicará expresamente la fecha de pago. El precio se pagará de la forma siguiente, quedando excluida cualquier otra forma de pago:

- cheque a la recepción de la factura,

- letra de cambio electrónica aceptada (LCRA),

- débito directo o

- transferencia.

En caso de pago mediante letra de cambio electrónica, el cliente deberá devolverla aceptada y firmada en un plazo máximo de quince (15) días naturales desde la fecha de facturación.

A los efectos de estas condiciones generales de venta, se entenderá por pago el cobro efectivo del instrumento en la fecha de vencimiento, no la mera entrega de un cheque o una letra de cambio electrónica (LCRA).

7.1.2 – El pago no podrá suspenderse, o demorarse, ni compensarse sin la previa autorización escrita de HAGER.

7.2 - Demora en el pago e impago

7.2.1 – En caso de demora en el pago, HAGER podrá suspender todos los pedidos del cliente en curso, sin perjuicio del sometimiento de la cuestión a los tribunales competentes.

7.2.2 – Las cantidades impagadas a su vencimiento devengarán intereses al tipo aplicado por el Banco Central Europeo (BCE) en su operación de refinanciación más reciente, más diez (10) puntos porcentuales. El tipo aplicable durante la primera mitad de un determinado año será el tipo del BCE aplicable el 1 de enero de ese año, y el de la segunda mitad del año será el aplicable el 1 de julio.

Conforme a lo establecido en el artículo 5 de la Ley 3/2004, de 29 de diciembre, por la que se establecen medidas de lucha contra la morosidad en las operaciones comerciales, los intereses se devengarán automáticamente sin necesidad de aviso de vencimiento ni intimación alguna por parte de HAGER.

7.2.3 – El incumplimiento total o parcial de las obligaciones de pago del cliente o la demora en su cumplimiento conllevarán un cargo de 40€, sin perjuicio de la indemnización que pueda corresponderle a HAGER por cualesquiera otros perjuicios sufridos.

7.2.4 – Si no se realizara el pago en el plazo de setenta y dos (72) horas desde la recepción de un requerimiento formal de pago (la fecha de recepción será la que aparezca en el acuse de recibo postal, en su caso), HAGER podrá cancelar la venta sin necesidad de iniciar ningún procedimiento judicial a tal efecto.

A elección de HAGER, la cancelación realizada en virtud de la presente cláusula no sólo será aplicable al pedido en cuestión, sino a todos los pedidos anteriores del cliente, con independencia de que hayan sido o no entregados, se encuentren en curso de entrega o se hallen impagados o no. En tal caso, el cliente deberá devolver a HAGER inmediatamente, a su propia cuenta y riesgo, los productos entregados que no hayan sido pagados en su totalidad y correspondan a los pedidos cancelados. La cancelación en los términos anteriormente establecidos operará sin perjuicio de cualquier otro derecho, en particular el de reclamar los daños y perjuicios sufridos por HAGER.

7.2.5 – El impago de una sola factura a su vencimiento dará lugar, a elección de HAGER, al vencimiento inmediato de todas las cantidades adeudadas.

8. Reserva de dominio

8.1 – HAGER conservará la propiedad de los productos hasta el pago total de su precio por el cliente, incluido el principal y los intereses y gastos accesorios, incluso cuando se amplie el plazo de pago. Cualquier cláusula en contrario, en particular las que puedan incluirse en condiciones generales de compra, se tendrá por no puesta.

8.2 – El cliente deberá mantener los productos en perfecto estado y asegurarlos frente a los riesgos habituales, en particular los de pérdida, destrucción y robo. En caso de daños, cualquier posible indemnización se transferirá a HAGER. El cliente deberá comunicar inmediatamente a HAGER cualquier siniestro o reclamación.

8.3 – El cliente deberá informar inmediatamente a HAGER en caso de administración judicial, liquidación u otra medida por insolvencia, así como en caso de embargo u otra actuación de terceros sobre los productos, indicando a HAGER los lugares exactos de almacenamiento de los productos entregados y aún no pagados. El cliente no podrá utilizar en modo alguno los productos entregados y aún no pagados como garantía y, en general, se abstendrá de realizar cualquier operación que pueda perjudicar la propiedad de HAGER.

8.4 – En caso de acuerdo expreso, HAGER podrá ejercitar los derechos reconocidos en esta cláusula sobre cualesquiera de sus créditos o productos que se hallen en poder del cliente (respecto a los cuales se presumirá que son productos cuyo precio está total o parcialmente impagado). A tal efecto, HAGER podrá recuperarlos como compensación por todas las facturas pendientes, sin perjuicio de su derecho a cancelar las ventas en curso.

8.5 – El cliente sólo podrá revender los productos de HAGER cuyo precio esté total o parcialmente impagado en el marco del funcionamiento ordinario de su negocio y no podrá en ningún caso pigno-

rarlos o constituirlos en garantía, ni transferir su propiedad en virtud de cualquier clase de garantía. 8.6 – Hasta el momento en que reciba el pago total de cualquier factura pagada, HAGER podrá exigir también la cancelación de la venta mediante el envío de un simple requerimiento formal. Del mismo modo, HAGER podrá, tras el envío de un requerimiento formal, realizar o disponer que se realice unilateralmente un inventario de los productos que se hallen en poder del cliente, quien se compromete expresamente a permitir el libre acceso a sus almacenes, tiendas u otras instalaciones a tal efecto, así como a garantizar en todo momento la posibilidad de identificar los productos de HAGER. 8.7 – HAGER se reserva el derecho a reclamar los productos en stock.

Esta cláusula no impedirá la transmisión del riesgo por la adquisición de los productos al cliente en el momento de la entrega (cláusula 3). El cliente se considerará un depositario de los productos desde el momento de la entrega.

9. Descuento por pronto pago

HAGER podrá conceder, si así se ha negociado, un descuento al cliente si este efectúa el pago correspondiente antes de la fecha resultante de la aplicación de las condiciones generales de venta (es decir, en menos de treinta (30) días naturales desde la fecha de recepción de los productos) o realiza el pago en efectivo. Las condiciones y términos específicos se establecerán con el cliente.

10. Garantía por vicios o defectos ocultos

10.1 – HAGER garantiza que los productos que vende están libres de vicios o defectos de diseño, materiales y fabricación durante un período de dos (2) años desde la fecha de fabricación marcada en el producto.

10.2 – La garantía por vicios o defectos ocultos definida en el apartado 10.1 es independiente de la garantía prestada por HAGER por defectos aparentes, falta de conformidad o falta de artículos, que el cliente sólo puede disfrutar con sujeción al cumplimiento de los plazos, condiciones y términos definidos en la cláusula 4 de estas condiciones generales de venta. La garantía por vicios o defectos ocultos se aplica con las excepciones y limitaciones establecidas en la cláusula 11 de las presentes condiciones generales.

10.3 – Dado que los clientes de HAGER son clientes profesionales o empresas, los vicios o defectos ocultos incluyen los defectos de fabricación del producto que lo hagan inadecuado para su uso normal y no sean detectables por el cliente en el momento de la entrega.

10.4 – En virtud de esta garantía, HAGER podrá optar entre la devolución al cliente del precio de venta del producto no conforme o la sustitución de la pieza o el producto defectuosos. Cualquier otra reparación, compensación o indemnización de cualquier clase y por cualquier motivo queda excluida.

10.5 – Para que sean tomados en consideración, los productos no conformes cubiertos por la garantía deberán devolverse a HAGER, previa aceptación por ésta mediante la firma de un documento de devolución de HAGER.

10.6 – Las devoluciones de productos señaladas en esta cláusula se realizarán siempre a costa y riesgo del cliente.

10.7 – La responsabilidad de HAGER está estrictamente limitada a las obligaciones expresamente estipuladas en estas condiciones generales. Queda expresamente excluida cualquier otra garantía, ya sea de naturaleza legal, expresa o implícita, incluidas, entre otras, las garantías expresas o implícitas de comerciabilidad o idoneidad para un determinado fin.

11. Exclusiones de la garantía

11.1 – Quedan excluidas de la garantía establecida en la cláusula 10 de estas condiciones generales de venta todas las piezas y consumibles que devengan inoperativos a causa del desgaste ordinario por el uso (incluidas, entre otras, las pilas o baterías, sean o no recargables).

11.2 – HAGER no responderá de los defectos y daños causados por condiciones anormales de almacenamiento o conservación en las instalaciones del cliente, en particular los debidos a cualquier clase de accidente.

11.3 – HAGER no responderá tampoco de los defectos y daños causados por el desgaste ordinario debido al uso, accidentes externos, negligencia, actos maliciosos, utilización en condiciones extremas (incluidos, entre otros, los ambientes húmedos, ácidos o polvorientos, las temperaturas elevadas, las emanaciones químicas, etc.), el uso anormal o defectuoso de los productos o el incumplimiento de las instrucciones de uso de HAGER.

11.4 – No será de aplicación ninguna garantía a los incidentes debidos a caso fortuito o fuerza mayor.

12. Derechos de propiedad intelectual y confidencialidad

12.1 – HAGER es el titular de todos los derechos de propiedad intelectual e industrial sobre sus proyectos, estudios y documentos de toda clase. Esta información no podrá revelarse o aplicarse sin la autorización por escrito de HAGER.

12.2 – En caso de revelación, la información deberá devolverse a HAGER a primer requerimiento.

12.3 – La tecnología y el know-how incorporados a los productos, estén o no patentados, y todos los derechos de propiedad intelectual e industrial relativos a los productos continuarán siendo propiedad exclusiva de HAGER.

13. Fuerza mayor

13.1 – A los efectos de estas condiciones generales de venta, se entenderán por caso fortuito o fuerza mayor aquellos acontecimientos que se hallen fuera del control de las partes y no pudieran haber sido razonablemente previstos, evitados o superados, en la medida en que su producción impida a las partes cumplir sus obligaciones.

13.2 – Se considerarán como supuestos de caso fortuito o fuerza mayor, a título meramente ejemplificativo, los de huelga de empleados y de los transportistas habituales, incendio, inundación, guerra, interrupciones de la producción por averías accidentales, imposibilidad de aprovisionamiento de materias primas, epidemia, límites de peso en carreteras por deshielo, bloqueos de carreteras, huelgas y cortes de gas o electricidad e interrupciones en el aprovisionamiento de los proveedores. En caso de producirse alguna de estas circunstancias, HAGER estará expresamente autorizada a no cumplir su obligación de entrega de los productos en los plazos inicialmente programados.

13.3 – En estos supuestos, HAGER deberá comunicar por escrito al cliente, en particular por fax o correo electrónico, en el plazo de setenta y dos (72) horas desde la fecha de producción del acontecimiento, que el acuerdo entre HAGER y el cliente queda suspendido desde la fecha de producción del acontecimiento, excluyéndose el derecho a reclamar ninguna clase de indemnización.

13.4 – Si la circunstancia de fuerza mayor o caso fortuito se prolongara durante más de treinta (30) días naturales desde la fecha de su producción, tanto HAGER como el cliente podrán cancelar el contrato de venta, sin derecho para ninguna de las dos partes a reclamar ninguna clase de indemnización o compensación de cualquier naturaleza.

13.5 – La cancelación surtirá efecto desde la fecha del acuse de recibo de la carta certificada por la que se resuelve el citado contrato.

14. Cesión

14.1 El cliente no podrá ceder, gravar, transferir o disponer de otro modo, total o parcialmente, de los derechos y obligaciones derivados del contrato de venta sin la previa autorización por escrito de HAGER.

15. Ley aplicable y jurisdicción competente

15.1 – Cualquier conflicto que pudiera surgir en relación con las condiciones generales de venta de HAGER o el contrato de venta celebrado entre HAGER y el cliente, incluidos los relativos a su validez, interpretación, cumplimiento y ejecución, quedan sometidos a los juzgados y tribunales de Barcelona (España).

15.2 – Todos los conflictos relacionados con estas condiciones generales de venta o con el contrato de venta, incluidos los relativos a su validez, interpretación, cumplimiento y ejecución, se regirán e interpretarán por las leyes españolas, excluidos los Derechos Forales.

15.3 – Serán de cuenta del cliente todos los costes de las actuaciones judiciales y extrajudiciales realizadas por HAGER para cobrar las deudas y exigir el pago del pedido en cuestión. Asimismo, todos los gastos relacionados serán de cuenta del cliente que hubiera incurrido en incumplimiento

(incluidos, entre otros, los costes de notificación o demanda formal, las costas judiciales y los honorarios de abogados y procuradores).

16. MISCELÁNEA

16.1 – Traducción. Las presentes condiciones están también disponibles en inglés. En caso de conflicto o contradicción entre ambas versiones, prevalecerá la versión en inglés.

16.2 – Divisibilidad. Si alguna cláusula de estas condiciones generales de venta o del contrato de venta, incluidas las limitaciones de garantía y responsabilidad, fuera considerada nula, ineficaz o inaplicable por una autoridad judicial o administrativa, ello no afectará a las restantes cláusulas, que conservarán plena vigencia y eficacia.

16.3 – Renuncia. La falta de ejercicio por HAGER de cualquier derecho conferido por las presentes condiciones generales de venta no se considerará como una renuncia al mismo, ni operará de manera que obstaculice el ejercicio de tales derechos en cualquier momento posterior.

16.4 – Riesgos de salud y seguridad de los productos. El cliente se compromete a implementar las actuaciones y medidas aplicadas por HAGER para evitar los riesgos que puedan presentar los productos, incluida su retirada del mercado, la adecuada y efectiva advertencia a los consumidores y la retirada de los productos comercializados que se hallen en poder de los consumidores.

16.5 – Modificación de los productos. HAGER se reserva el derecho a realizar en cualquier momento los cambios que considere necesarios en sus productos y, sin que ello conlleve la obligación de cambiar los productos ya entregados o en proceso de entrega, a modificar, sin previa notificación, los modelos definidos en sus folletos, catálogos y, en general, en cualquier documento comercial o publicitario.

Delegaciones y subdelegaciones

España



- Oficina Área
- Oficina Delegación o Subdelegación
- Agentes desplazados

Área Este

□ Irlanda 15
P. Ind. Pla de Llerona
08520 Les Franqueses del Vallès
(Barcelona)
Teléfono 938 467 622
Telefax 938 618 875
Balears 666 594 593

Delegación Levante

○ Edificio Albufera
Plaza de la Alqueria de Culla 4
4ª planta - Oficina 408
46910 Alfafar (Valencia)
Teléfono 961 225 292
Telefax 963 723 960

Balears:
Teléfono 666 594 593

Canarias:
Teléfono 610 299 845

Murcia:
Teléfono 670 730 315

Área Sur

□ Paseo Cerrado de Calderón 13
Edif. Multicentro, local 25
29018 Málaga
Teléfono 952 200 021
Telefax 952 206 015

Delegación Sevilla

○ Parque Empresarial
Nuevo Torneo
Astronomía s/n
torre nº 4 - planta 8ª - oficina 12
41015 Sevilla
Teléfono 952 200 021
Telefax 952 206 015

Área Centro

□ Puerto de la Morcuera 13
1ª planta local 11
28919 Leganés (Madrid)
Teléfono 985 525 466
Telefax 985 521 832

Toledo, Cuenca, Ciudad Real

Teléfono 952 200 021
Telefax 952 206 015

Área Norte

□ Avda. Conde de Guadalhorce 43
2º Oficina B
33401 Avilés (Asturias)
Teléfono 985 525 466
Telefax 985 521 832

Delegación Norte

○ Gordoniz 44
4ª planta - Departamento 6
48002 Bilbao
Teléfono 985 525 466
Telefax 985 521 832

Delegación Galicia

○ Calle Pedras 12 - Entlo.
15142 Arteixo (A Coruña)
Teléfono 985 525 466
Telefax 985 521 832

Contacte
con nosotros:

▶ N° Telf.

Ver teléfonos de contacto
para cada zona, en esta
página.

▶ Web

hager.es/asistencia-tecnica



Hager Sistemas S.A.U.

Alfred Nobel 18
Pol. Ind. Valldoriolf
Apartado 39
E-08430 La Roca del Vallès

Teléfono 938 424 730
Telefax 938 422 132
hager.es



hager.es/tarifas